

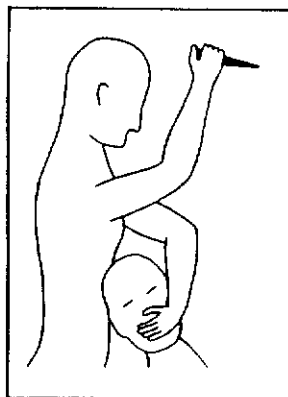

21

**TECHNIQUES
OF SILENT
KILLING**



Master Hei Long

**PALADIN PRESS
BOULDER, COLORADO**

21 Techniques of Silent Killing
by Master Hei Long

Copyright © 1989 by Master Hei Long

ISBN 0 87364-508-1

Printed in the United States of America

Published by Paladin Press, a division of
Paladin Enterprises, Inc., P.O. Box 1307,
Boulder, Colorado 80306, USA
(303) 443-7250

Direct inquiries and/or orders to the above address.

PALADIN, PALADIN PRESS, and the "horse head" design
are trademarks belonging to Paladin Enterprises and
registered in United States Patent and Trademark Office.

**All rights reserved. Except for use in a review, no
portion of this book may be reproduced in any form
without the express written permission of the publisher.**

**Neither the author nor the publisher assumes
any responsibility for the use or misuse of
information contained in this book.**

Contents

Introduction	1
Chapter One: Manual Weapons	3
Chapter Two: The Spike	13
Chapter Three: The Knife	45
Chapter Four: The Nunchaku	71
Conclusion	97

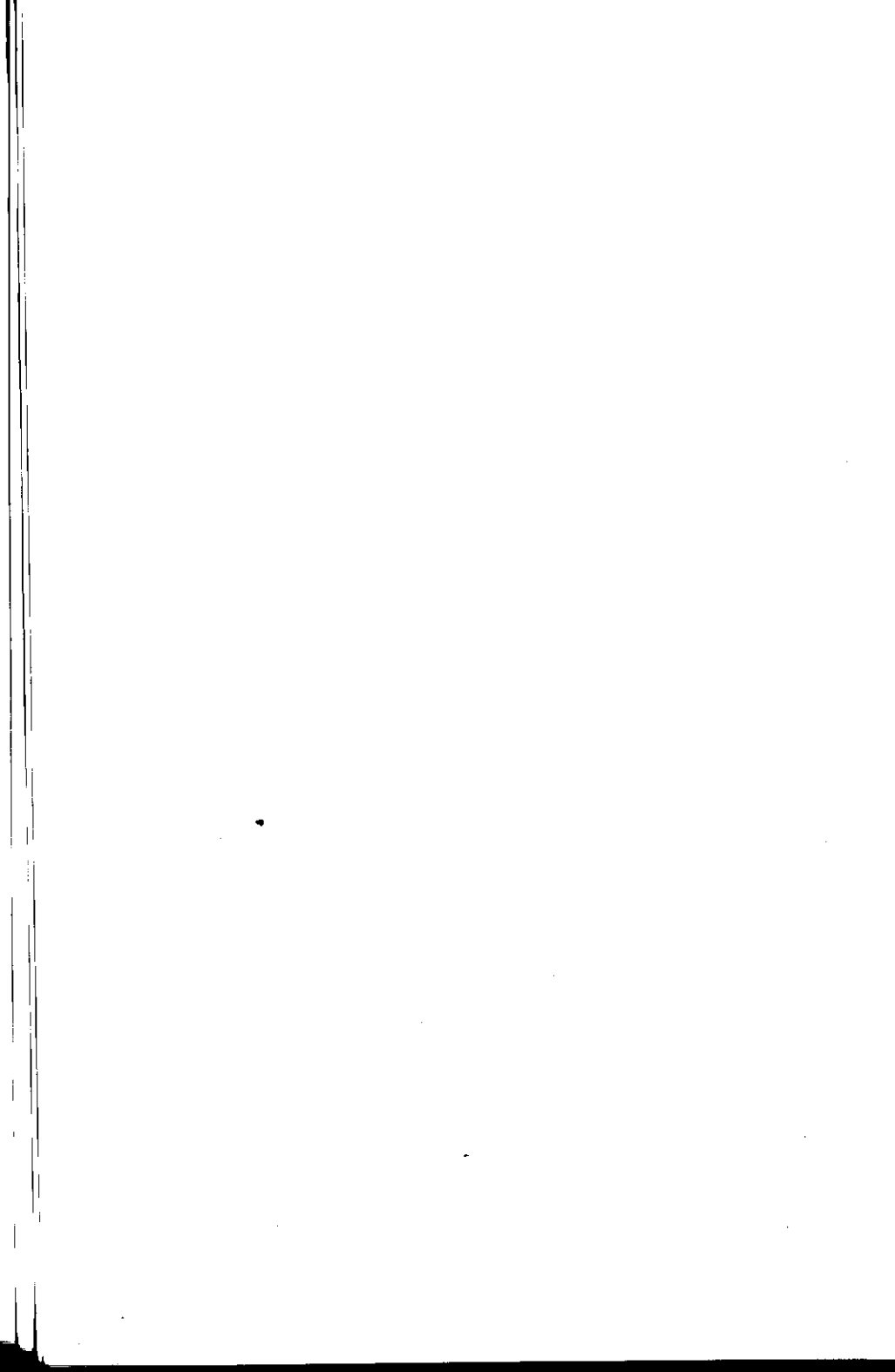

Introduction

The techniques comprising this work present methods of assassination requiring silence, close contact, and the intent to leave the scene without being apprehended. All the weapons herein are utilized manually, with full body contact—the use of projectile weapons will not be discussed. In all these techniques, the assassin approaches an unsuspecting target and kills him with a single stroke, attracting as little attention as possible in the process.

We show how an assassin attacks walking targets from the front, from the side, and from the rear. We will also show how he can attack seated targets from side and rear approaches. If you flip through the chapters, you will notice that, with the exception of the techniques in Chapter Four, each sequence ends with the assassin leaving the scene of the action while the victim is still falling to the floor. An assassin's job is done when the target has expired.

It is also an assassin's job to survive so he can continue to use his skills when they are needed. This requires that he get in, locate his target, and neutralize him without being captured. When he has completed his task, the assassin must turn and walk away without hesitating. He must look

does not go to a local retailer to make such a purchase simply because he may be remembered and later identified as having made the buy. From a legal standpoint, this could put a murder weapon in his hand. Due to the simplicity of making a spike, purchasing a substitute constitutes unreasonable risk.

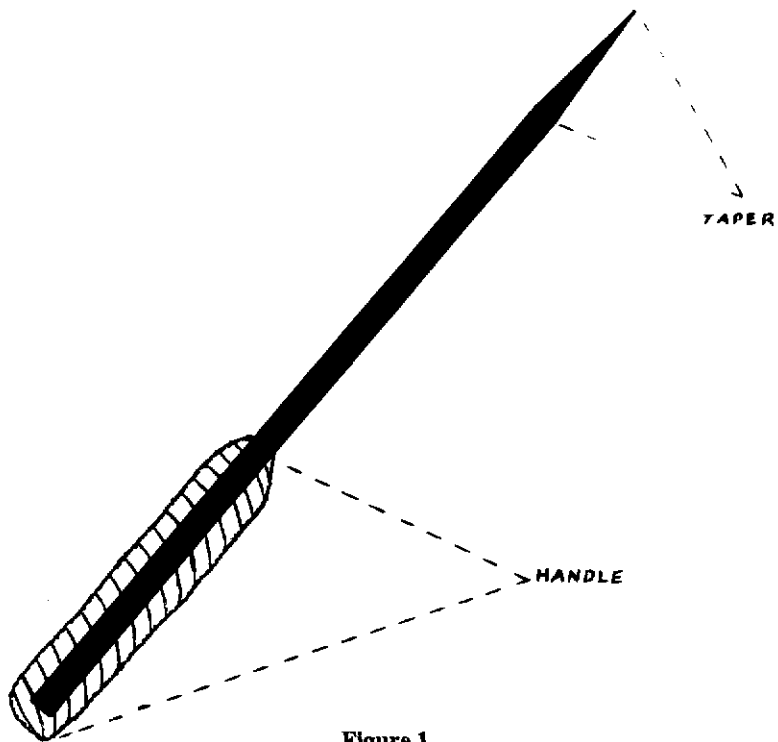

Figure 1

Figure 1 depicts a suitable spike for assassination purposes. Ideally, the spike's shaft should be ten inches long, round, and about as thick as a pencil. (Actually, for certain

targets, a pencil with a sharpened tip would be of sufficient length and strength to get the job done, but it would be undependable for others.) The taper of the shaft should be from one and a half to two inches long and free of burrs or niches. The tip of the shaft must be able to pass freely through clothing without catching on material and creating a drag on the thrusting force. Burrs and niches will cause this drag and may redirect the penetration of the weapon, so be sure the shaft and the tip are smooth.

The handle should be approximately four inches in length, but may be longer according to the size of the wielder's hand. A long cloth strip makes the best handle. This strip must be securely anchored to the shaft at the initial windings, and should cover the blunt end of the weapon, as illustrated in Figure 1.

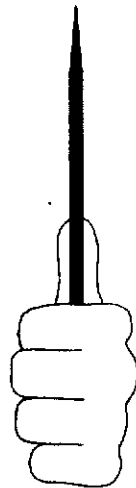

Figure 2

Like any other weapon, use of the spike requires proper manual control. The techniques utilizing the spike shown here require two types of grips. Figure 2 shows the first grip, with the weapon protruding from the top of the hand. The four fingers are clamped around the handle and the thumb is pressed against the shaft to stabilize it and prevent it from deviating to the side upon impact. This grip is used for horizontal thrusts and rising thrusts.



Figure 3

Figure 3 shows the second type of grip, with the weapon protruding from the bottom of the hand. Here the thumb is being used to bolster against the backthrust of the weapon when it contacts the target. The grip is applied to certain horizontal strokes and all downward strokes.

It should not be necessary to stress the importance of a firm grip on the weapon. This is made possible by the proper construction of the handle. A sloppily made handle

with loose wrappings will be difficult to control, and thus will make a tight grip difficult to maintain. The length of the user's fingers will determine the circumference of the handle. He should take extra care to properly fit the handle to his hand.

The Knife

Figure 4 shows a fighting knife. Both sides of the blade are sharpened, and it is tapered evenly to a point on both sides. A knife that has a single cutting edge and/or a curved tip requires specific angles to make it effective within the focus of this book (silent killing techniques). An executioner is after full efficiency, and a knife with one side that is unable to cut is only half a knife.

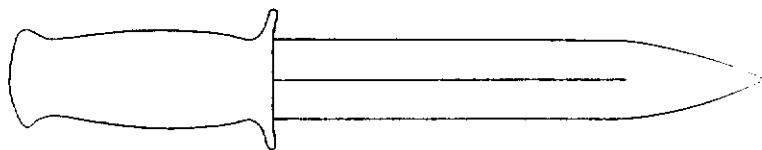

Figure 4

Good fighting knives are light and, as a rule, have a molded handle (which is generally made of an aluminum alloy) fused to the blade. The blades are made of surgical steel, allowing for an extremely sharp point. Blades come in a variety of sizes, but a long blade is preferable. The blade illustrated in Figure 4 would be approximately ten inches in length, which is a good-size blade. It would be hard to miss a target with a knife that size.

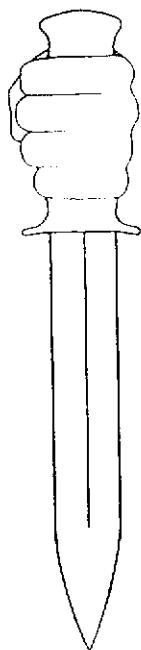

Figure 5

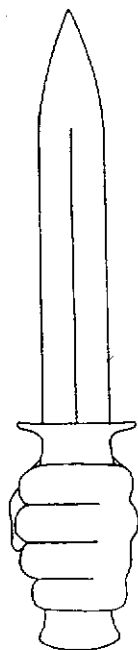

Figure 6

Figure 5 depicts a bottom grip, which is used in all downward vertical strokes and some horizontal strokes. Note that the thumb is wrapped around the handle, unlike the grips applied to the spike. A knife of this size requires all the wielder's strength on the handle to control it, and therefore his thumb should be wrapped around the handle for a secure grip rather than used as a pitch stabilizer. The inside grip shown in Figure 6 is used in all upward strokes,

some parallel strokes (when a thrust is called for), and certain horizontal strokes. It should go without saying that a knife that will be used for an assassination should be honed and stropped to razor sharpness.

The Nunchaku

A great deal of mystique surrounded the nunchaku when it first became available to the American public, but it didn't take long before half the youths in the country were carrying them around and flashing them like toys. I have personally observed ten- and twelve-year olds performing passes and strikes with blinding speed and accuracy.

At first, the weapon's potentially lethal capabilities weren't recognized by the authorities, but many states eventually outlawed the weapon. According to a student of mine (a former federal prosecutor), the courts consider nunchaku to be as deadly as firearms. Though the weapon can be utilized as an efficient bone-crushing tool to immobilize an opponent, here we are going to consider it for its lethal applications only.

Figure 7 shows a standard set of nunchaku, but since the weapon became commercialized, a wide variety is now available. They may be purchased in weights starting at ten ounces and, when I last looked, as heavy as thirty-two ounces. Overall lengths vary from ten to sixteen inches, and the binding material between the sticks ranges from a single nylon strand of four inches to ten inches of link chain. The weapon can come with studs, grooved grips, and round or octagonal sticks.

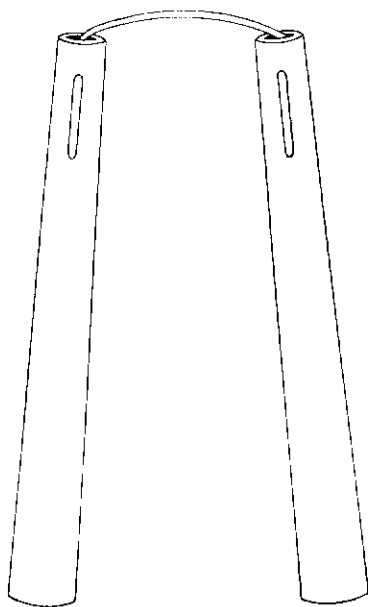

Figure 7

A good choice is a 14-inch, 14-ounce nylon-strung weapon with octagon-shaped sticks. Fourteen inches of length and fourteen ounces of weight is sufficient to dismantle vulnerable parts of the human anatomy, and a nylon cord is preferable over a chain because the latter makes a lot of noise. Given the way the nunchaku will be used in this text, the length of the cord joining the two sticks together should not exceed four inches.

The nunchaku can best be used in one way and in one place—in its compression capacity around the victim's neck. The objective is to crush the cervical vertebrae on one side and the trachea and larynx on the other.

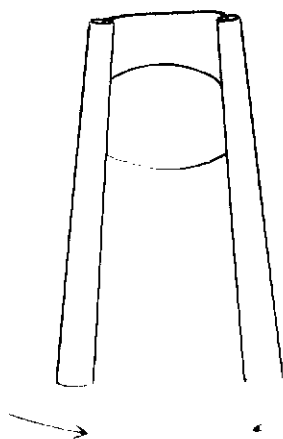

Figure 8

Figure 8 shows the weapon clamped around the circumference of a victim's neck. The low end of each stick is used as a lever to apply pressure to the front and back side of the neck, which is trapped at the upper end close to the cord. Figures 9, 10, and 11 illustrate the various grips that will be used in the text (palms facing in, palms down, and one up/one down, respectively). Depending on where the assassin is in relation to the target, he will use one of these grips in conjunction with the techniques discussed in Chapter Four.

Study these grips and experiment with them to get used to the feel of the nunchaku. To give you a good understanding of just how effective this weapon is when used as a compression instrument against the anatomy of the neck, put the sticks around your own neck and gently press them together. This experiment will also give you an idea of how much pressure to put on your training partner in practice.

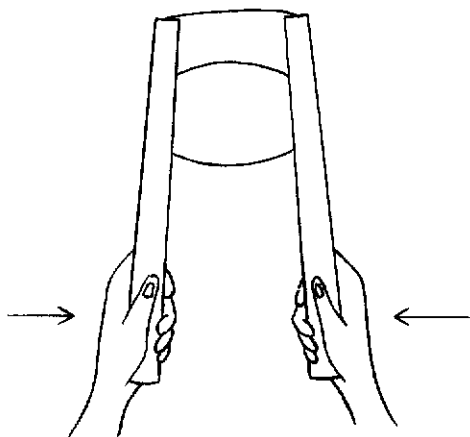

Figure 9

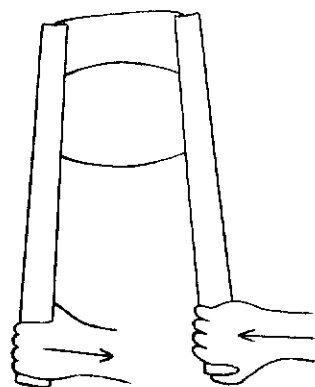

Figure 10

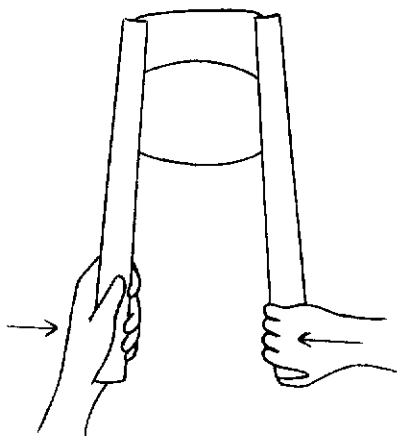

Figure 11

Chapter Two

The Spike

To accomplish a silent kill, an assassin must quickly cause the death of his target without him having the opportunity to yell or call for help. Therefore, he *must* make an unseen approach, or at least an inconspicuous one. If the target sees the assassin and is aware of his intentions, he is likely to create a disturbance to attract attention and, he hopes, some help.

An assassin must also deal with the pain factor. In most cases, the impact of the attack will cause traumatic shock, immediately paralyzing the victim and rendering him unconscious. A lethal blow, however, does not always bring death so quickly that the opponent does not at least cry out from the pain inflicted by the stroke. It only takes one gasp of air expelled across the vocal cords to effect a yell loud enough to attract the attention of anyone within range of the sound.

One of the prime anatomical areas to attack is the subternal notch. A strike to this part of the body will paralyze the diaphragm, making it impossible for the victim to yell. Death will be so instantaneous that there will be no

opportunity to call for help or yell from pain. The other two vital areas we will discuss, the temple and the heart, will bring death very quickly, but without the guarantee that the victim will not have enough air in his lungs to cry out just before he expires. As long as the diaphragm is functional, it can be flexed, forcing air to pass through the vocal chamber to create sound.

There are two ways to deal with this problem. During an assassination, the executioner can compress the esophagus and larynx so that no air can be expelled through the mouth, or he can cover the mouth so that any sound will be a muffled grunt that will most likely go unnoticed. Four of the seven techniques in this chapter will require the victim's mouth to be held momentarily.

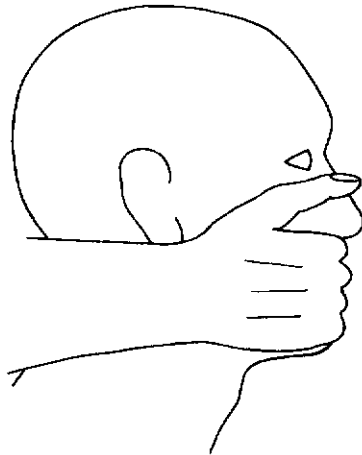

Figure 12

Observe Figures 12 and 13. Typically, when a mouth grab is required for a technique, it will be in this fashion.

An alternate grab will be used in one of the techniques, but since there is a special purpose for this, that grab will be discussed with the explanation of that technique. What is important here is that the fingers form as tight a seal as possible over the entire mouth, pressing *hard* against the lips. The assassin's grip should leave a bruise over the victim's mouth area.

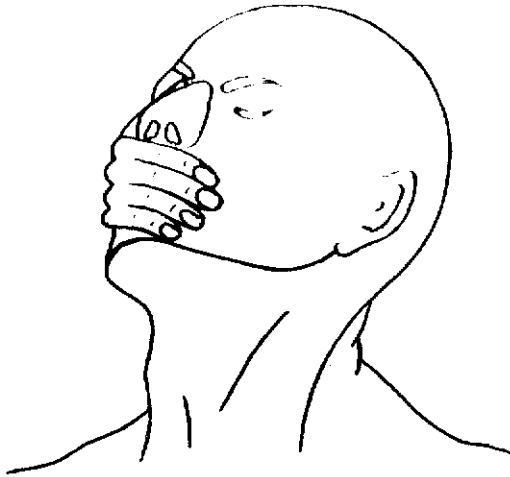
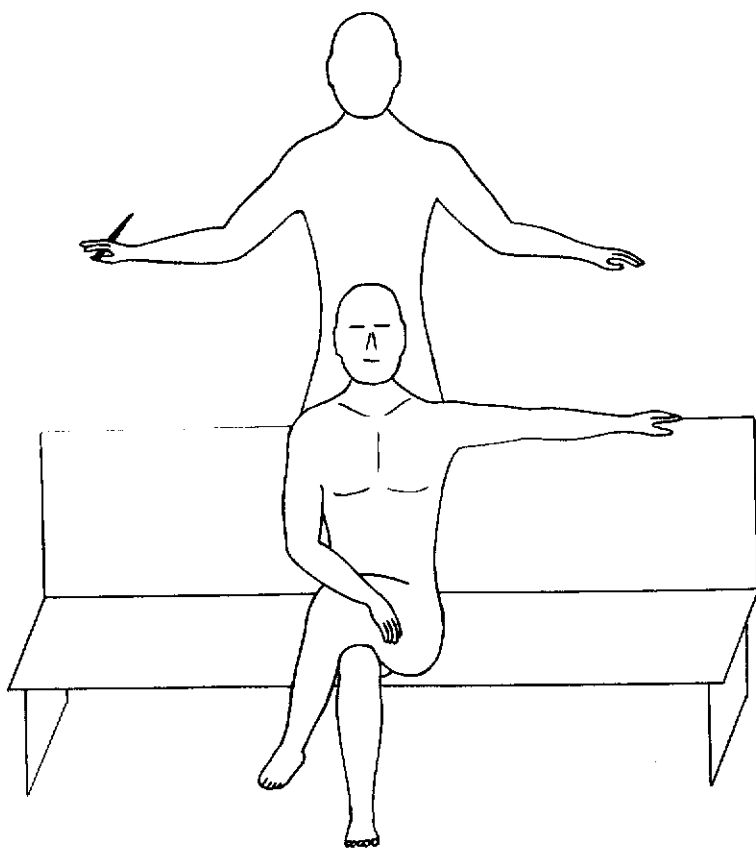

Figure 13

Technique 1

In Figure 14, the target is seated in a relaxed position—the assassin's approach is from directly behind him. The first contact with the target comes when the assassin covers his mouth to prevent him from yelling. He raises

**Figure 14**

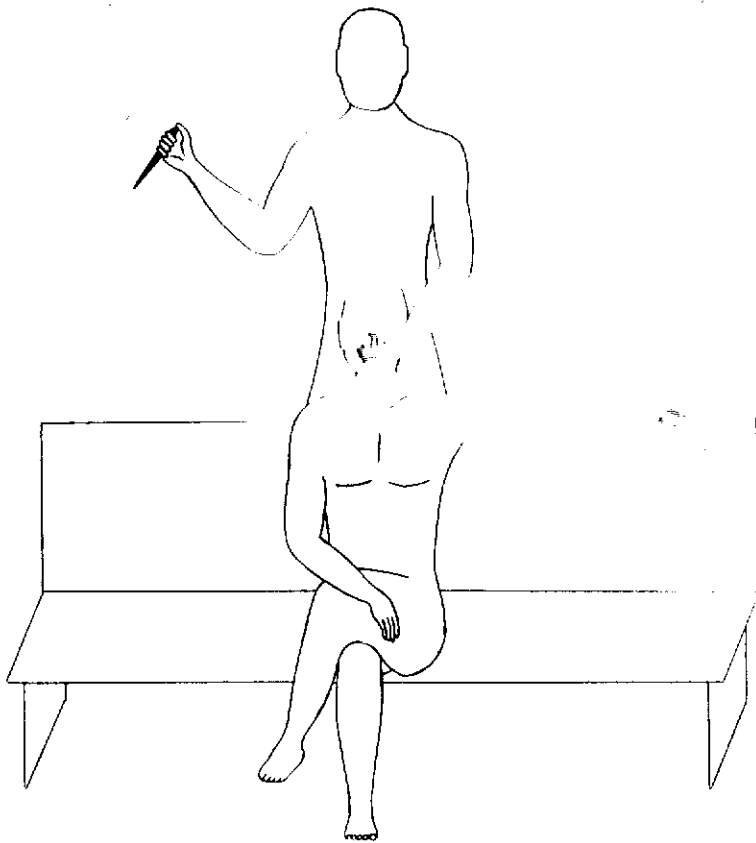

Figure 15

the spike as he takes this grip (Figure 15). Because the victim's head may interfere with the stroke, the attacker turns his head to the side, as shown in Figure 16. *This is not a separate movement—the mouth grab and the turn of the*

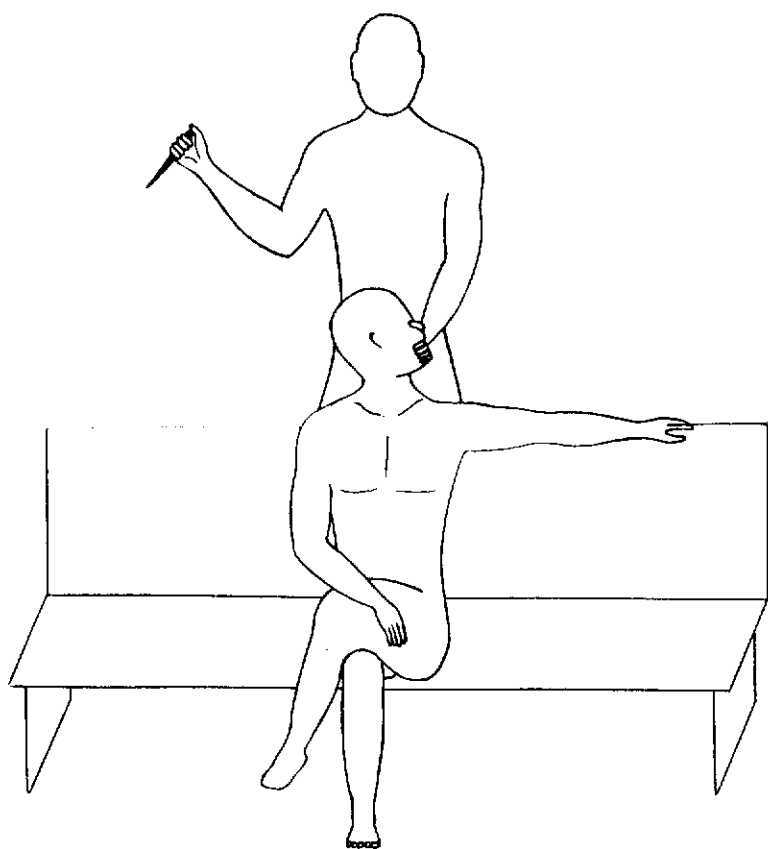

Figure 16

head are done simultaneously. With a single hard thrust, he buries the length of the spike into the victim's heart (Figure 17) by penetrating the lower center portion of the sternum. (For more detailed information on this and other vulnerable

areas of the human anatomy, see *Dragons Touch*, available from Paladin Press.) The heart will arrest on impact. The assassin may release his mouth as soon as he has completed the thrust.

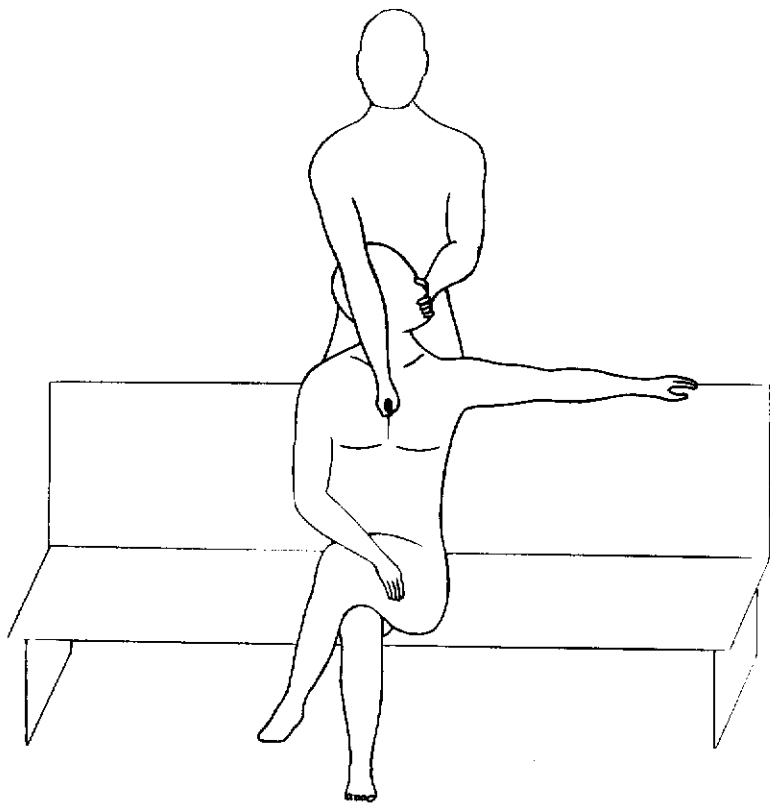

Figure 17

In Figure 18, you will see that the assassin is walking away even before the target has completely fallen. Once he has brought the spike down through the sternum and into the heart, his commitment has been fulfilled. It is now his obligation to avoid capture. He should leave immediately.

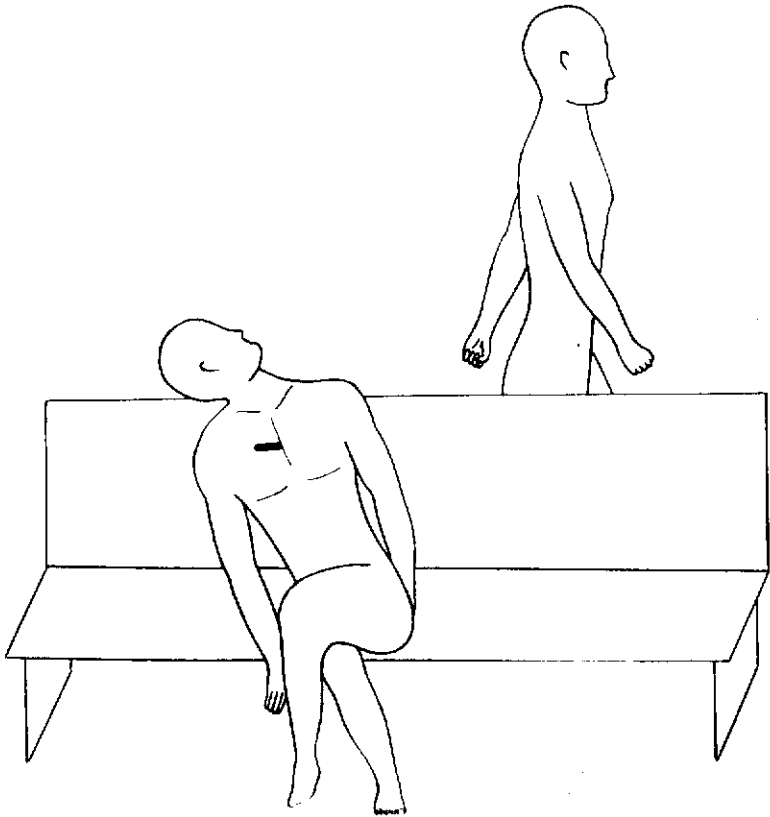

Figure 18

Technique 2

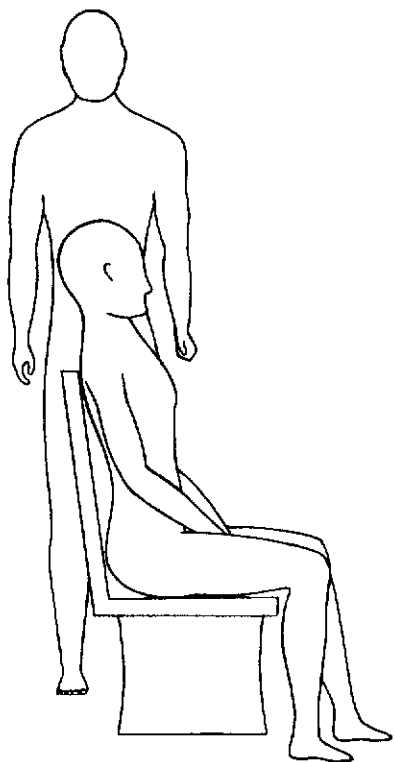

Figure 19

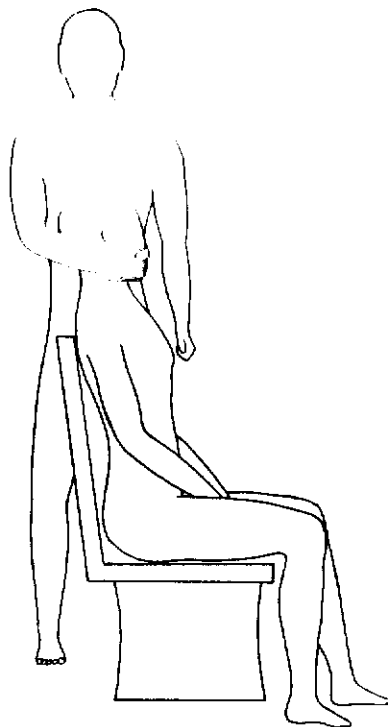

Figure 20

Again the assassin is going to go after the heart, and again with the target seated, but this time approaching him from the side (Figure 19). Notice that the spike is being held in such a way that if the target took notice of his executioner's approach, he would not see a weapon in his hand. The weapon is being held with a bottom grip and his wrist is bent so that the length of the spike lays against the underside of his forearm.

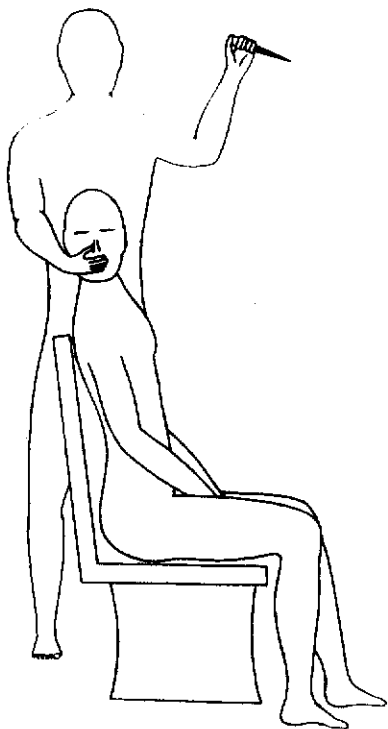

Figure 21

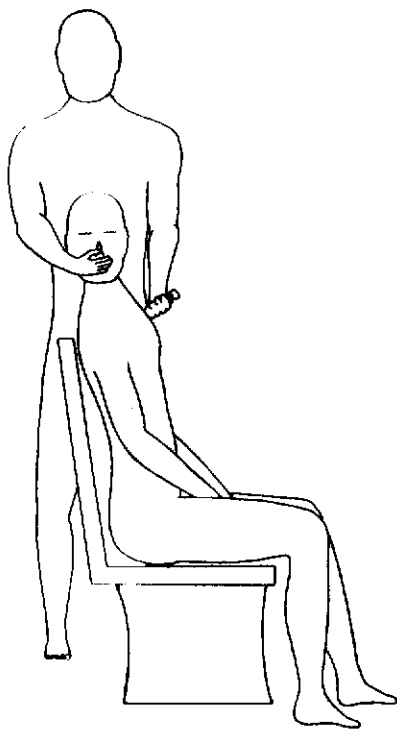

Figure 22

The final step toward the victim is quick and long, with the right foot stepping behind the chair slightly. The assassin grabs the target's mouth at this time (Figure 20). He turns his head as shown in Figure 21—this will keep him from bending forward by extending the cervical vertebrae, and it will also keep him from making eye contact with the weapon. Bringing the weapon down in an

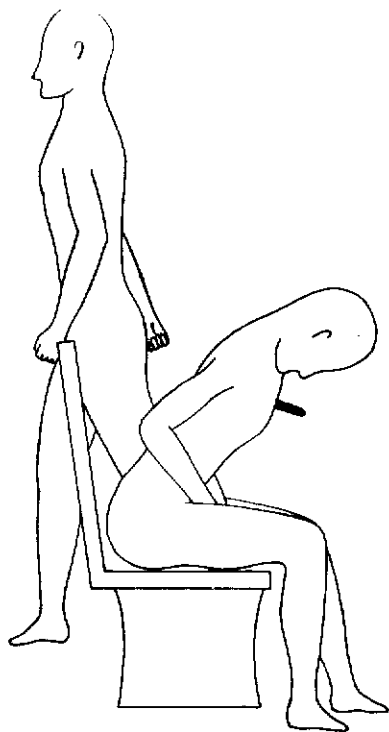

Figure 23

arc, the executioner penetrates the victim's sternum and lodges the shaft in his heart (Figure 22). After the thrust is completed, the attacker releases him immediately and walks away (Figure 23). His job is finished.

Technique 3

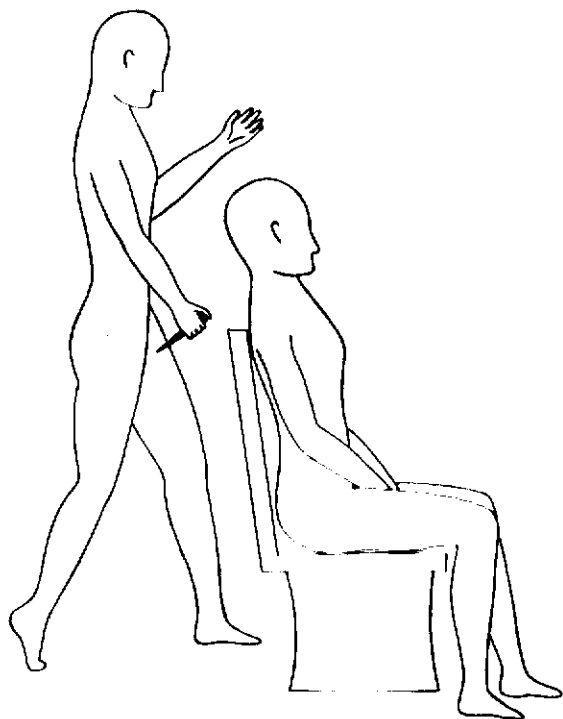

Figure 24

The anatomical target for this technique is the supra-sternal notch. It is another vulnerable area that offers access to some of the most vital targets of the human body—the trachea and the major blood vessels of the upper heart.

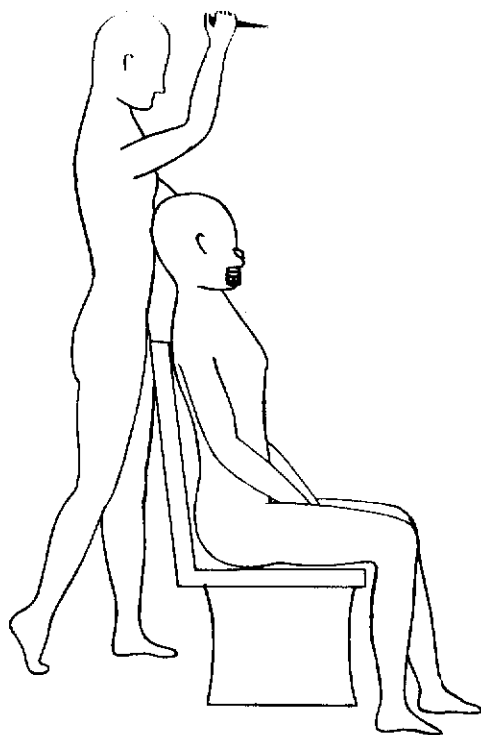

Figure 25

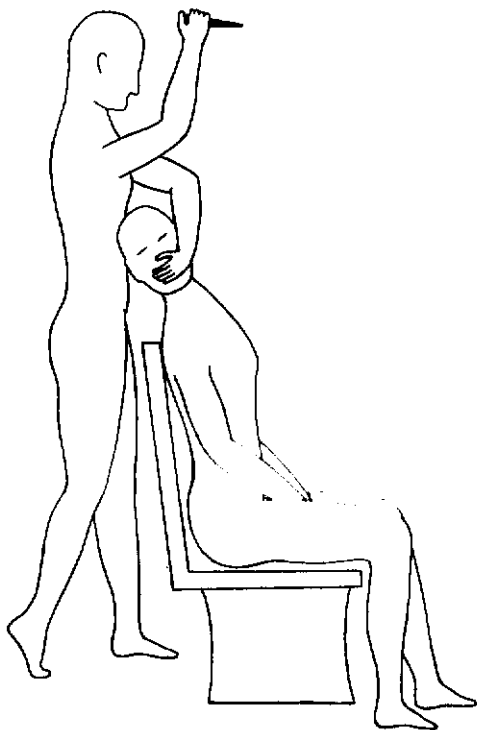
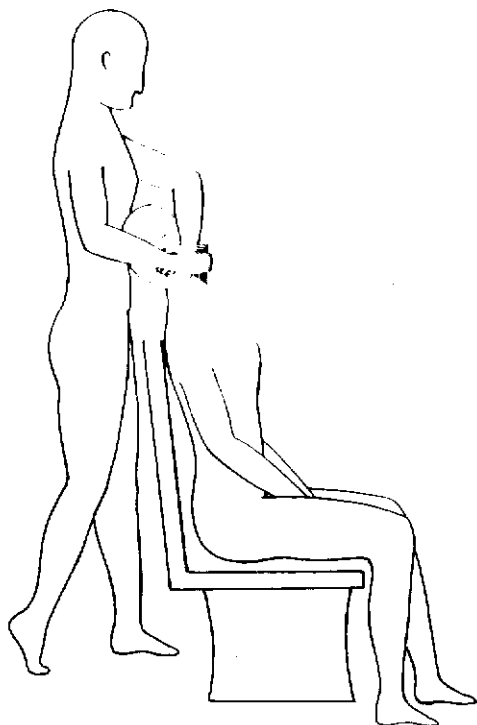

Figure 26

The assassin approaches a seated target from the rear, as depicted in Figure 24. He covers his mouth and raises the weapon for the strike (Figure 25). He turns the victim's head to the side (Figure 26). As with the last technique, this is done immediately upon contact with the mouth—it is *not* a two-part movement.

**Figure 27**

At the base of the neck, there is a slight depression at the top of the sternum where the collarbones come together. This is the suprasternal notch and the penetration point for this technique. The spike is to be thrust down into this depression (Figure 27). As always, the attacker makes his way to the door or exit route before the target falls completely to the ground (Figure 28).

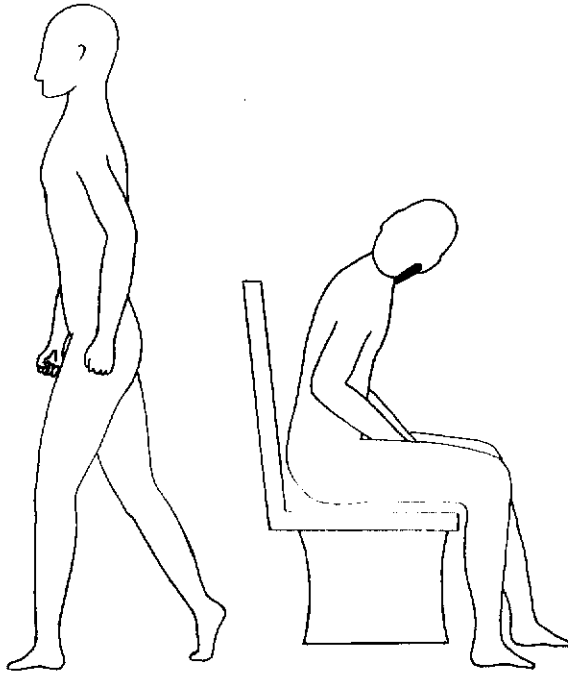

Figure 28

As depicted in Figure 29, the initial penetration is straight up and down. Now observe Figures 30 and 31. This side-to-side movement is executed at impact, tearing the aorta and superior vena cava and expediting the death of the victim.

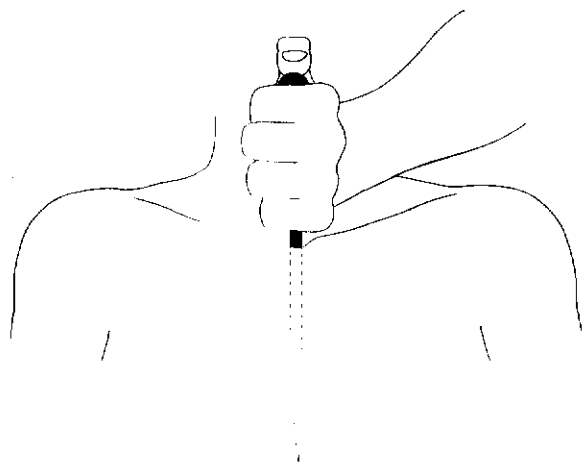

Figure 29

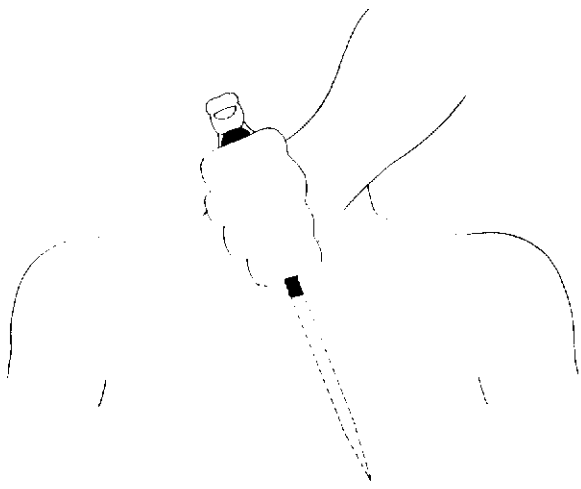

Figure 30

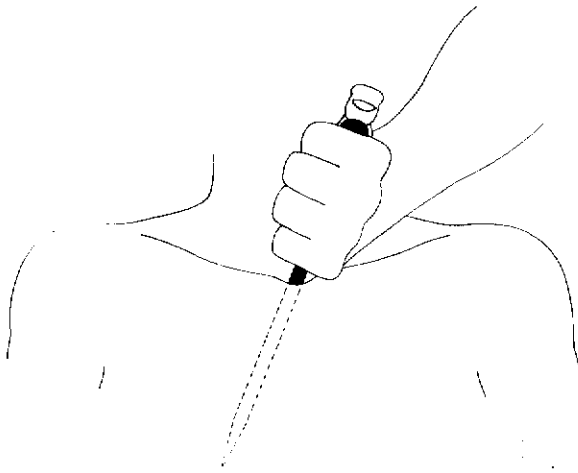

Figure 31

Technique 4

In this technique, the point of impact is the victim's temple. A strike here will result in penetration of the brain, hemorrhaging, and death.

In Figure 32, the target is shown walking. The assassin's approach is from the rear. Again, to prevent the possibility of the target crying out, the attacker grips his mouth while simultaneously drawing the strike, as shown in Figure 33. He pulls the target's head back toward him and, with a circular horizontal stroke, buries the length of the spike into his temple (Figure 34). He pushes the body back and out of his path as he walks away (Figure 35). The victim will have expired before he hits the floor.

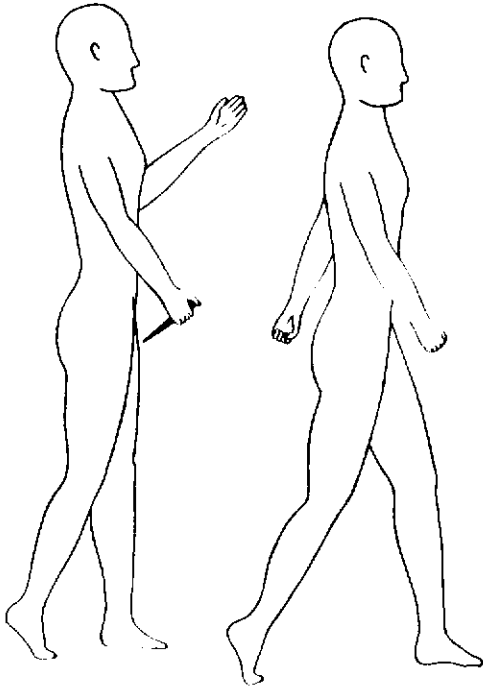

Figure 32

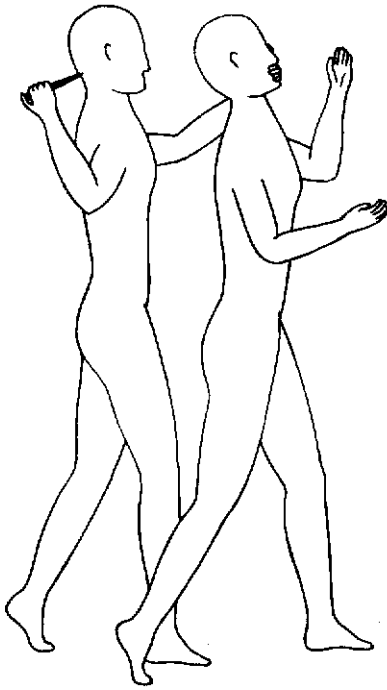

Figure 33

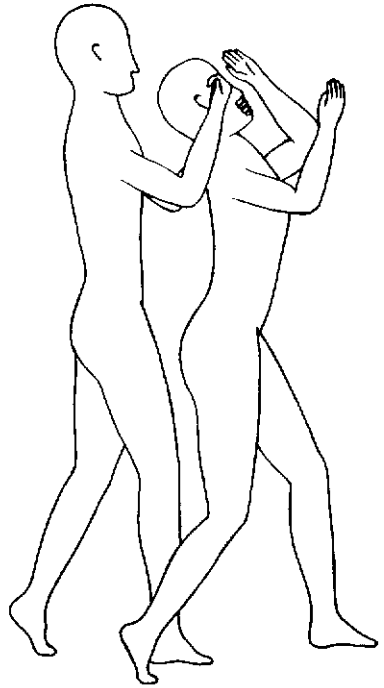

Figure 34

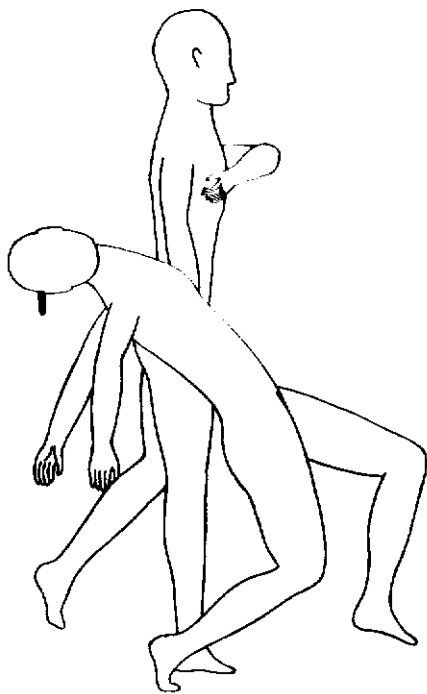

Figure 35

Technique 5

For the last three techniques in this chapter, the assassin hits what is probably the best choice of targets on the human anatomy for silent killing, the substernal notch. A thrust into this area will accomplish instant paralysis of the diaphragm, resulting in the inability of the target to cry out in any way. His death will follow instantaneously, as the weapon will penetrate the length of his heart from its bottom side.

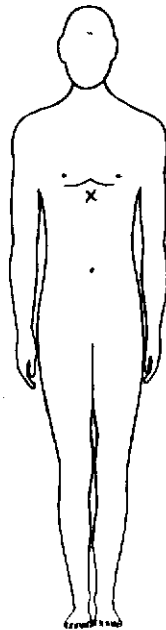

Figure 36

Figure 36 illustrates the surface location of the substernal notch. When the attacker strikes this area, angle and impact are critical. His thrust must be on an acute angle, as shown in Figures 37 and 38. What he is actually doing with this stroke is piercing the heart without having to pass through the sternum. He avoids the need for a hard thrust to pass through the cartilaginous structure by reaching under it.

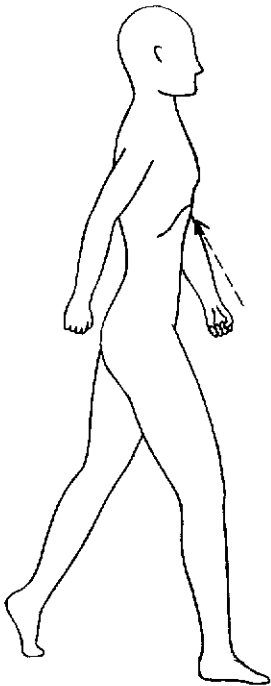

Figure 37

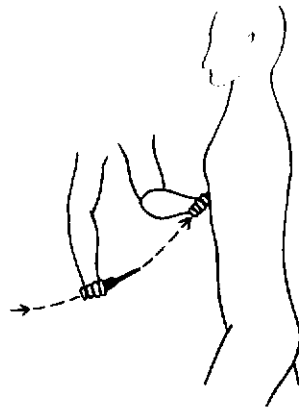

Figure 38

If the assassin's thrust is so strong, however, that his fist makes hard contact with the sternum's surface area, he will force the air in the diaphragm through the victim's mouth, which might enable him to yell. The objective for a silent kill (via the paralysis caused by penetrating the diaphragm) will be neutralized because the attacker will have forced air through the vocal cavity himself. If he does *not* make hard contact with the target's chest, the diaphragm will be paralyzed on impact and the spike will freely pass into the heart, resulting in a silent kill.

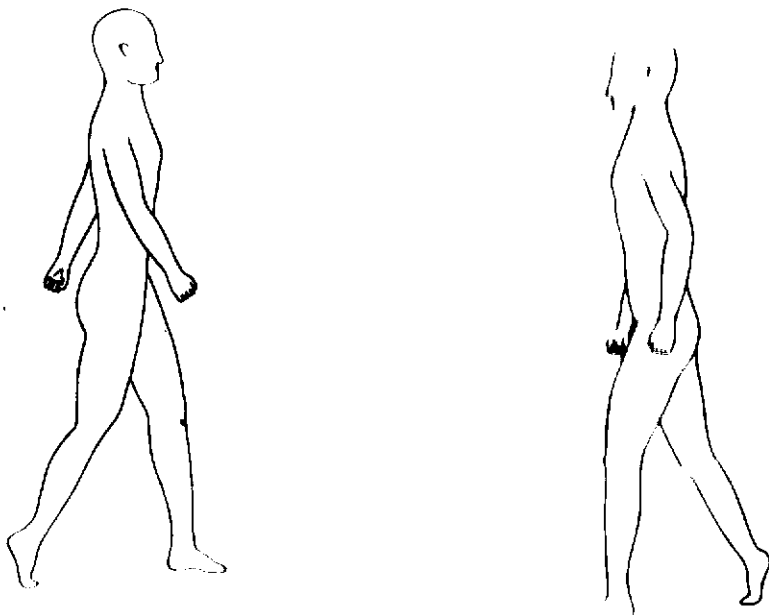

Figure 39

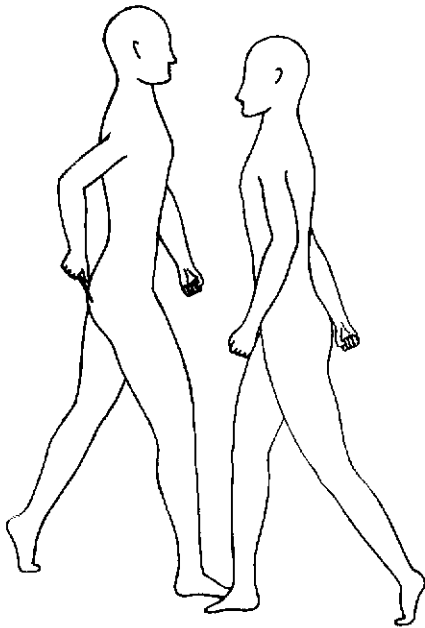

Figure 40

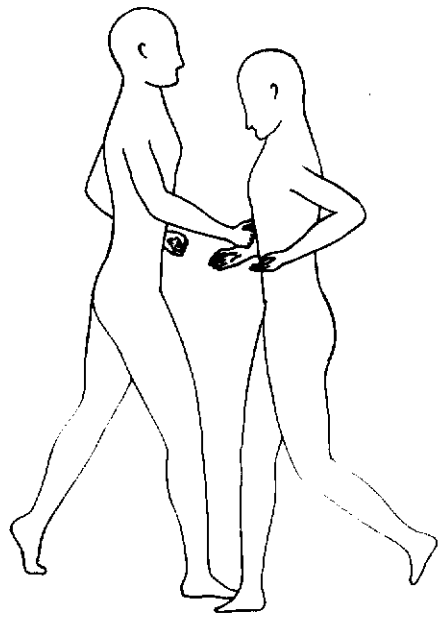

Figure 41

In Figure 39, the assassin approaches the target head-on. You will note that the spike is *not* in his hand at this point — it is in his right rear pocket. Just as he begins to pass his target, he reaches back and draws the weapon from his pocket (Figure 40). Right from the drawing point, he thrusts the weapon into the substernal notch, as depicted in Figure 41. The executioner never stops walking — his motion is continuous through the impact of the thrust. As the target falls to the ground, he is still walking, never having broken his stride (Figure 42).

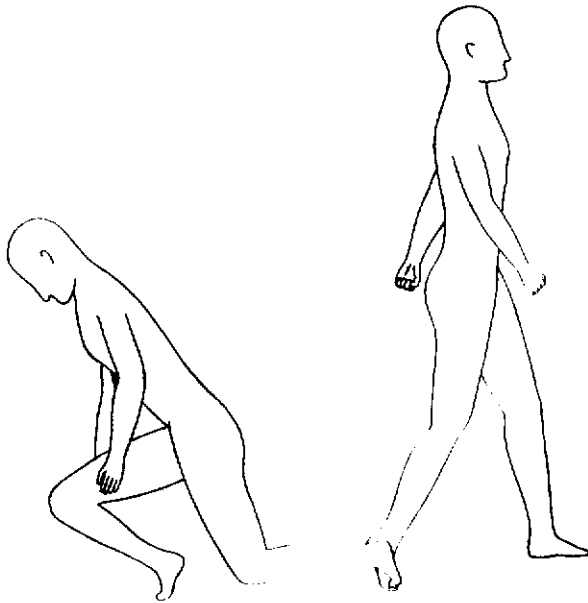

Figure 42

Technique 6

The next technique is simple and quick. The assassin will not be approaching the victim; rather, he will be coming at the assassin. This technique would most appropriately be used when the target has a predictable habit of walking through a certain area at a certain time of day. If he usually passes close to a wall, the attacker should stand against that wall. If he comes down the center of a wide corridor, the attacker should slowly move into that area of the corridor as he approaches to get close enough to intercept him.

The executioner spots the victim's approach with his peripheral vision (Figure 43). He does not look in the direction from which the victim is approaching, and he does

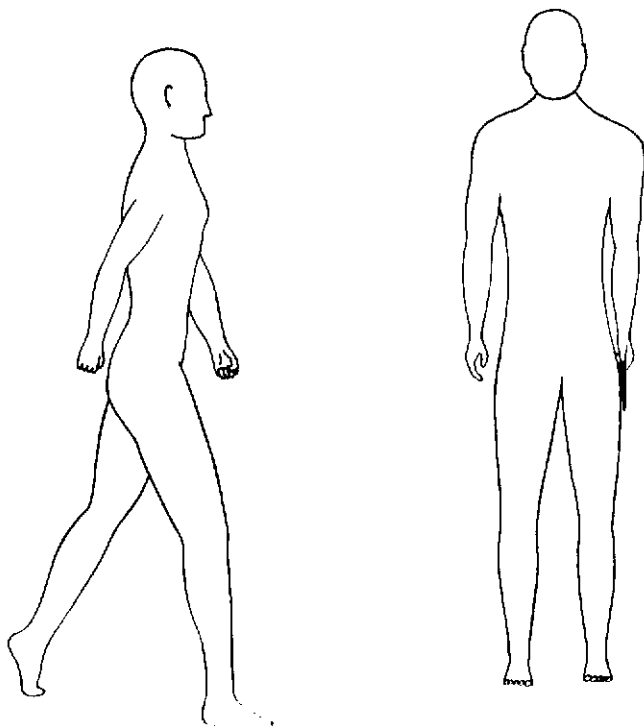

Figure 43

not turn toward him until the last possible moment. When the target has reached the proper proximity, he turns to his right with a short step and thrusts the spike into the sub-sternal notch (Figure 44). This is an in-progress thrust; in

other words, once the assassin has begun to move, his pivot, step, and thrust are all done in one smooth, sequential motion. He should continue walking directly to the door

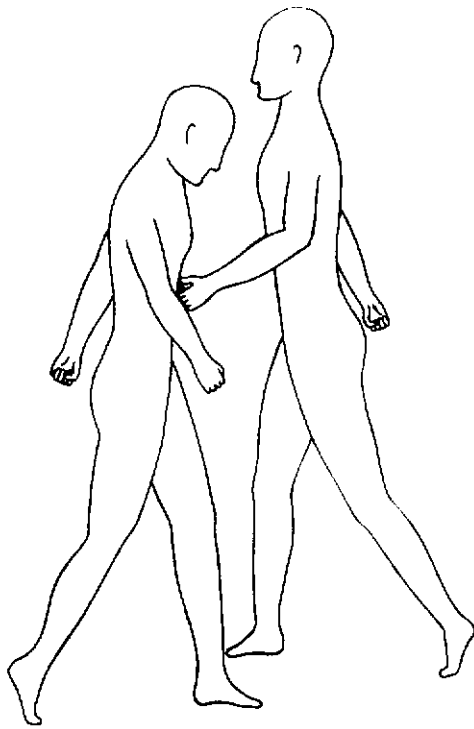

Figure 44

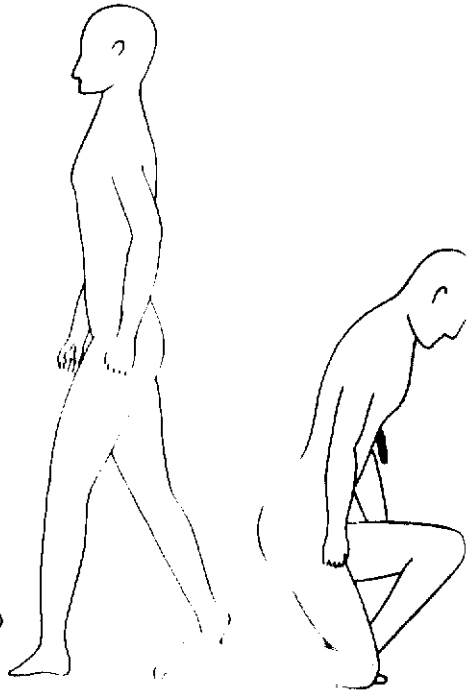

Figure 45

that he had previously planned on using as his exit (Figure 45). A person unaware of the assassin's intentions could be looking right at him while he executes this technique and have no idea what had happened until he rolled the target over and saw the spike sticking out of his chest.

Technique 7

In this final sequence, the assassin will be using a mouth grab with a thumb pressure technique to expose the target to a clean stroke.

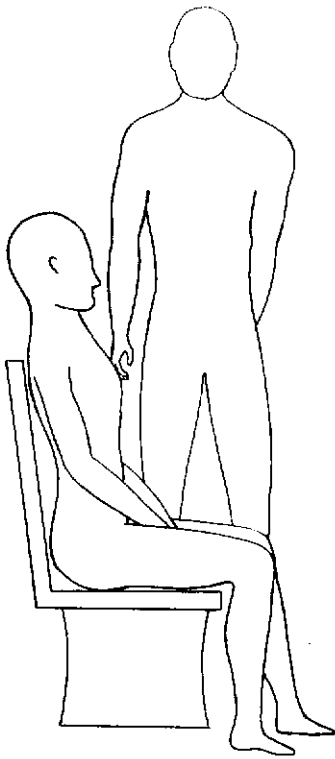

Figure 46

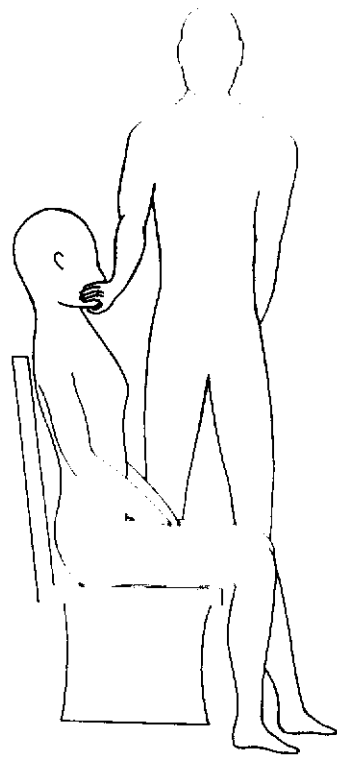

Figure 47

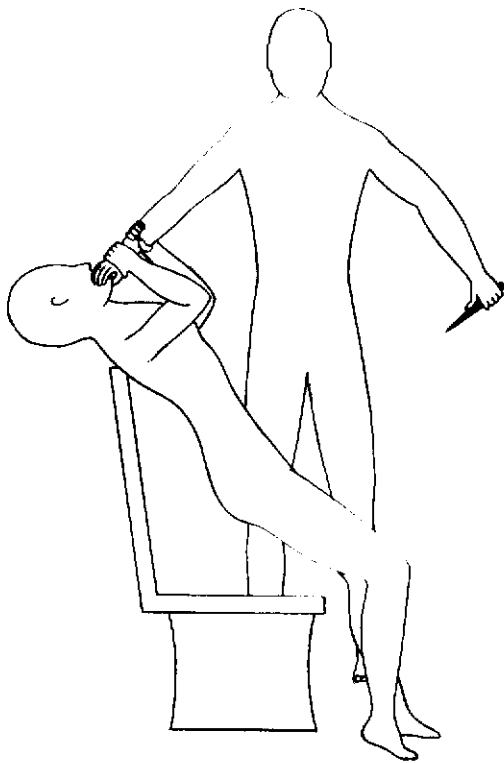

Figure 48

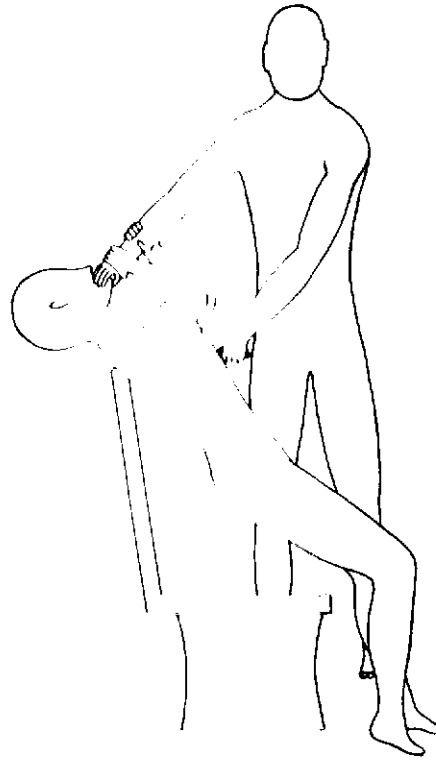
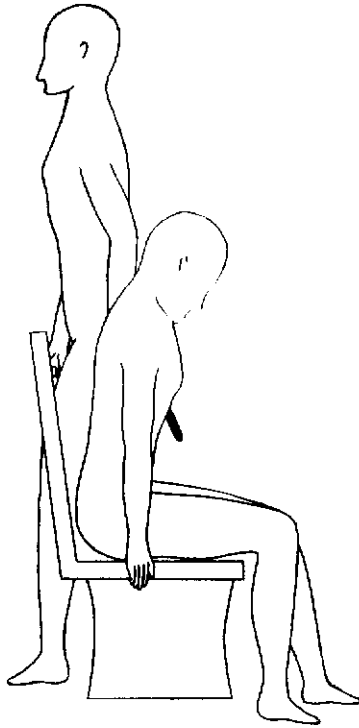

Figure 49

In Figure 46, the target is seated and the assassin is approaching from his left side. Note that unlike Technique 2, here the attacker is positioned slightly to the *front* of the seated target. This is necessary for him to perform the initial grip on his mouth.

**Figure 50**

He lays the four fingers of his right hand across the target's mouth and firmly presses his thumb under his chin (Figure 47). This is a sensitive area, so the target will try to pull away from the pain. As he does, the assassin pushes in the same direction the victim is pulling and draws the weapon (Figure 48). He thrusts the spike into the substernal notch, as depicted in Figure 49. He then releases him and immediately walks away (Figure 50).

also be fatal, but this, too, is not a guaranteed quick kill. To maintain the state of "life," the body requires respiratory function, neural contact between the brain and the involuntary muscles, and the flow of blood throughout the body, especially to the brain. Stop the flow of blood to the brain and the body will cease to receive cerebro-neural instructions. The heart will stop functioning and the target will die.

Technique 8

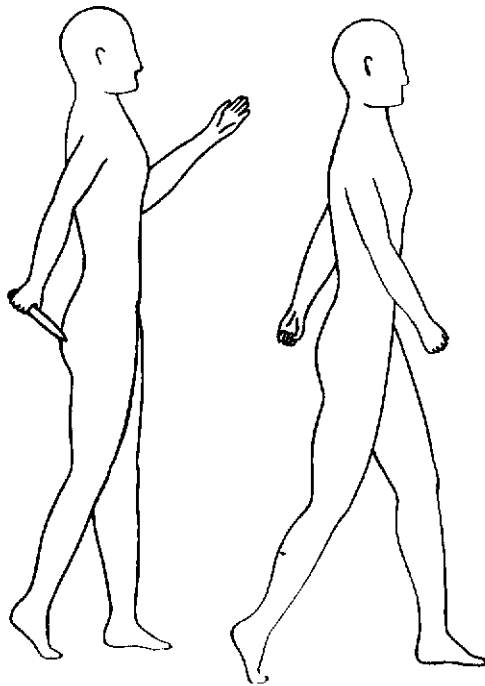

Figure 51

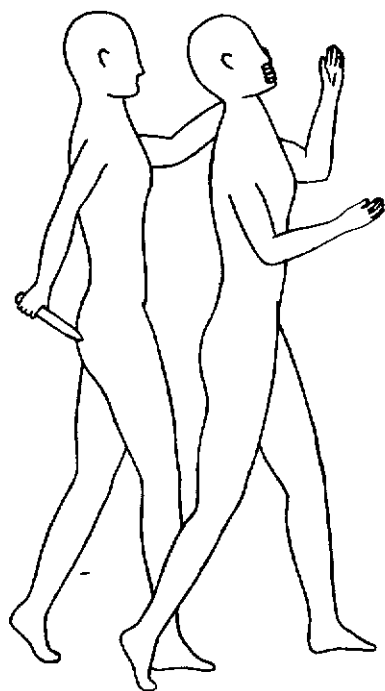

Figure 52

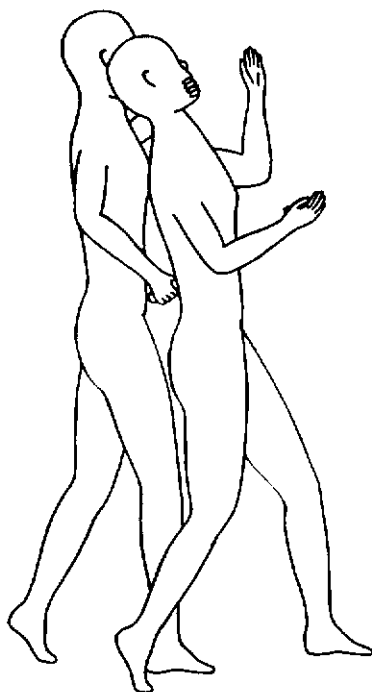

Figure 53

In Figure 51, the executioner approaches his target from the rear. He moves in quickly and, with his left hand, covers the target's mouth with the standard grip described in Chapter Two (Figure 52). He pulls the target's head to his right shoulder and, with a powerful thrust, buries the blade in his right kidney (Figure 53). This is a very painful strike, so the attacker must be sure that his grip over the victim's mouth is done properly so he cannot cry out. He

holds the mouth for a count of three, pushes the target out of his way, and continues walking toward his predetermined exit (Figure 54).

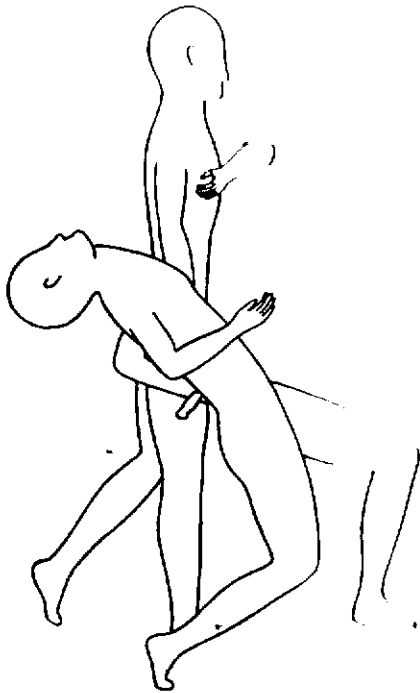

Figure 54

Technique 9

In this sequence, the assassin is going after the kidney again, but rather than catch up to the target from behind, he attacks him while he is passing by.

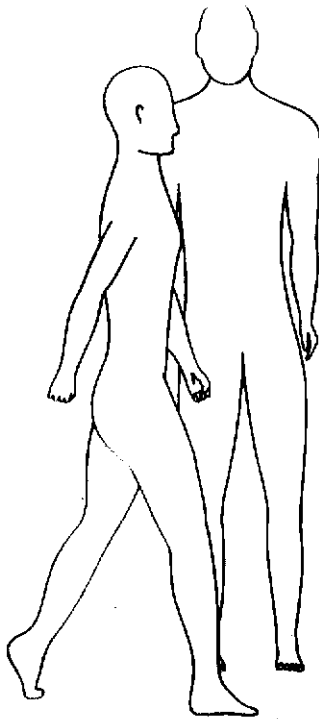

Figure 55

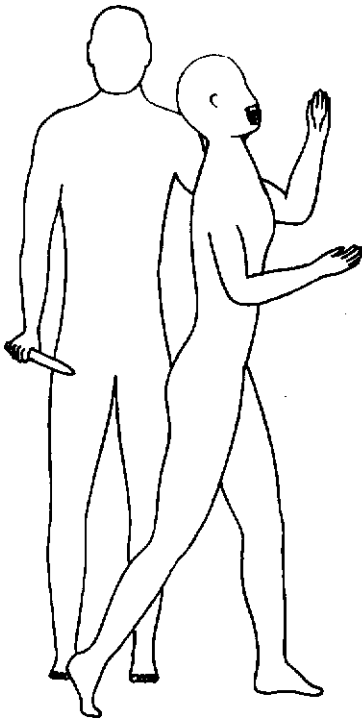

Figure 56

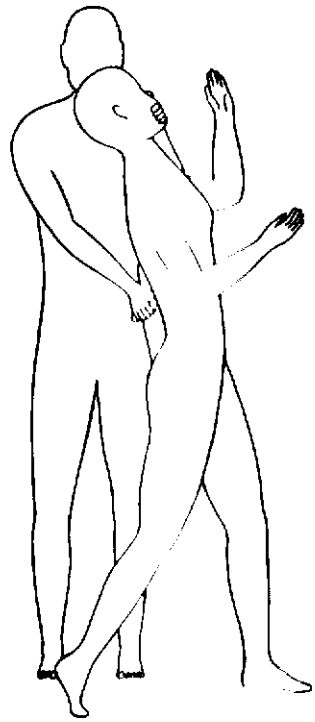

Figure 57

In Figure 55, the assassin is standing in an area where he knows the target must pass by. The knife is hidden behind his back at his waistline. Just as the target passes, the attacker reaches in front of him, clamping his mouth and pulling his head back. He then draws the knife in preparation for the strike (Figure 56). Continuing the rearward pull, he thrusts the knife into the target's left kidney, as shown in Figure 57. He holds him in this position for a count of

three, releases the knife and the grip on the victim's mouth, and calmly walks to his exit (Figure 58).

In this and the previous technique, it is mentioned that the target's mouth should be held for a three count. Because of the intense pain inherent with a kidney thrust, too quick a release may allow the target's yell to be heard, so it is important that the assassin maintains his grip until that danger has passed.

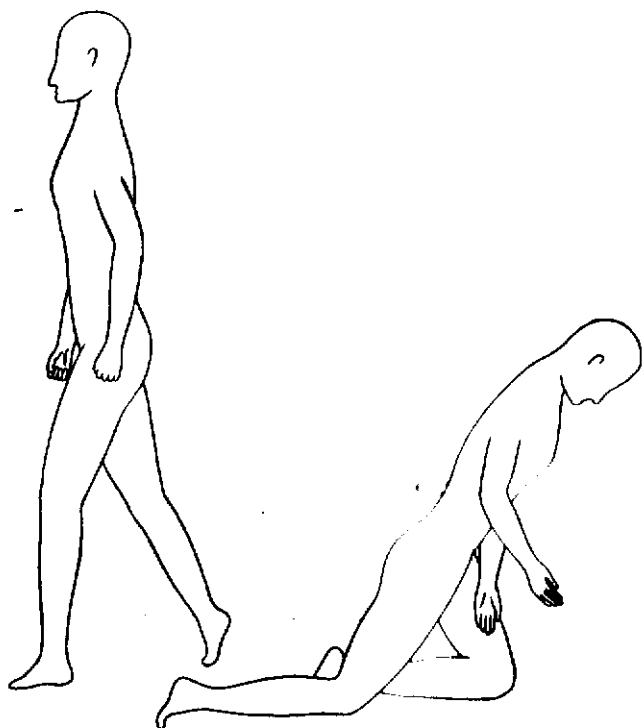

Figure 58

Technique 10

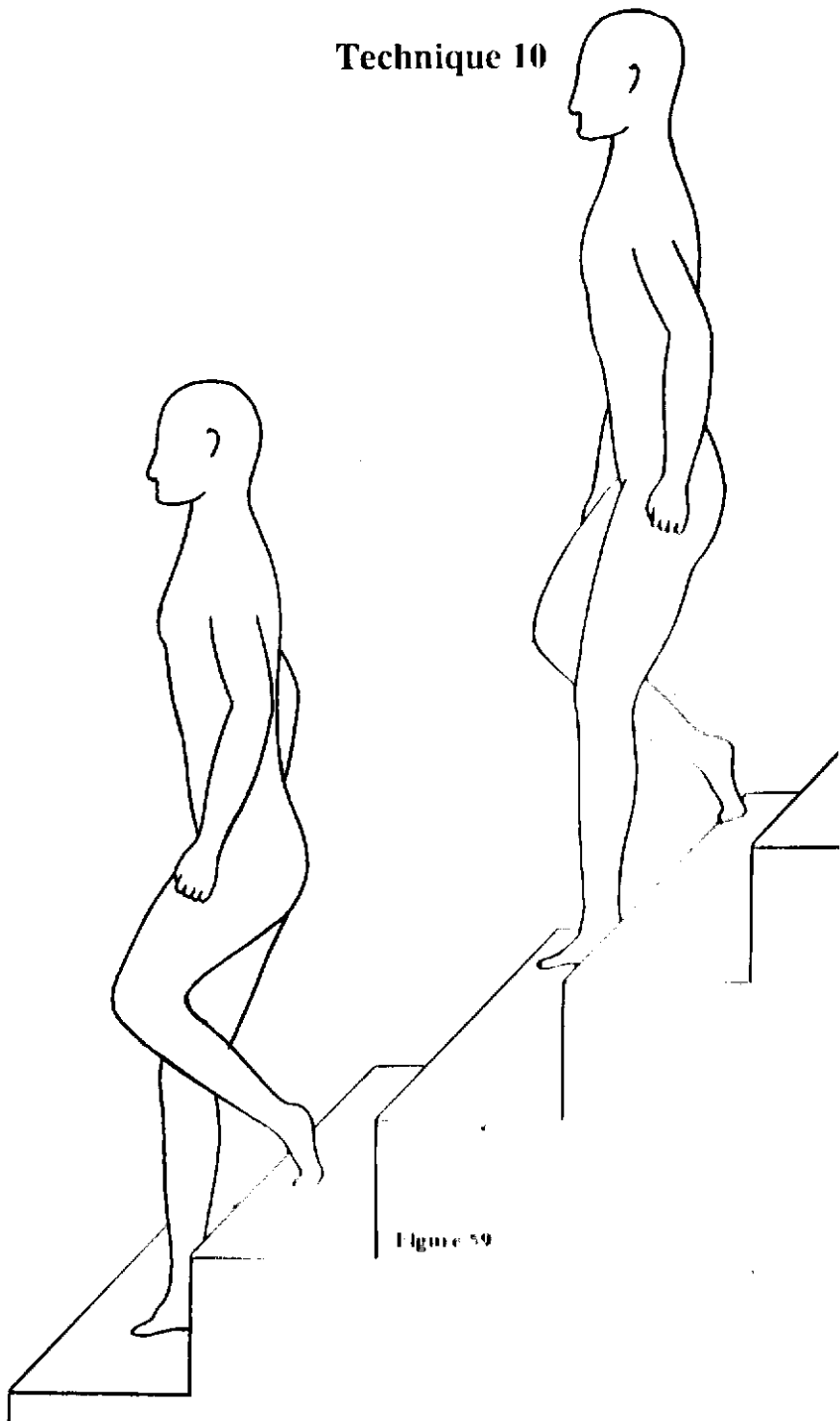

Figure 59

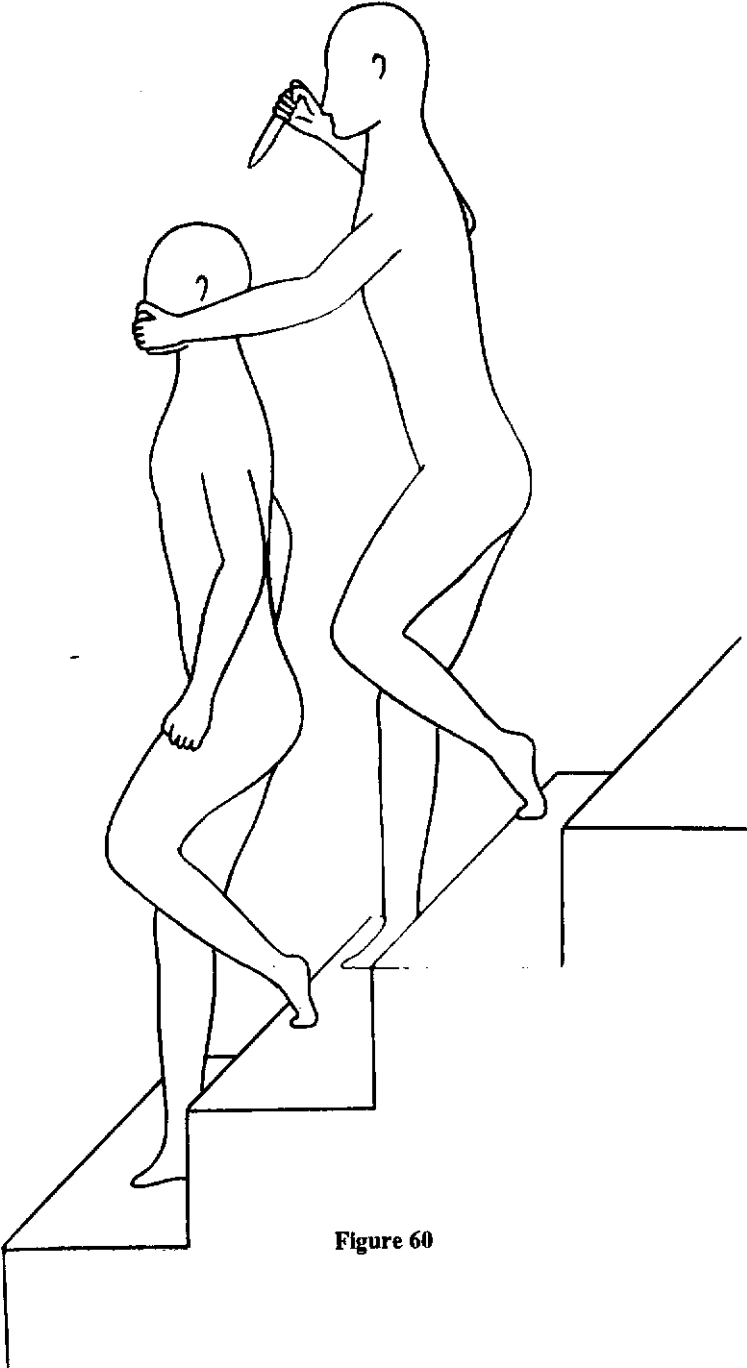

Figure 60

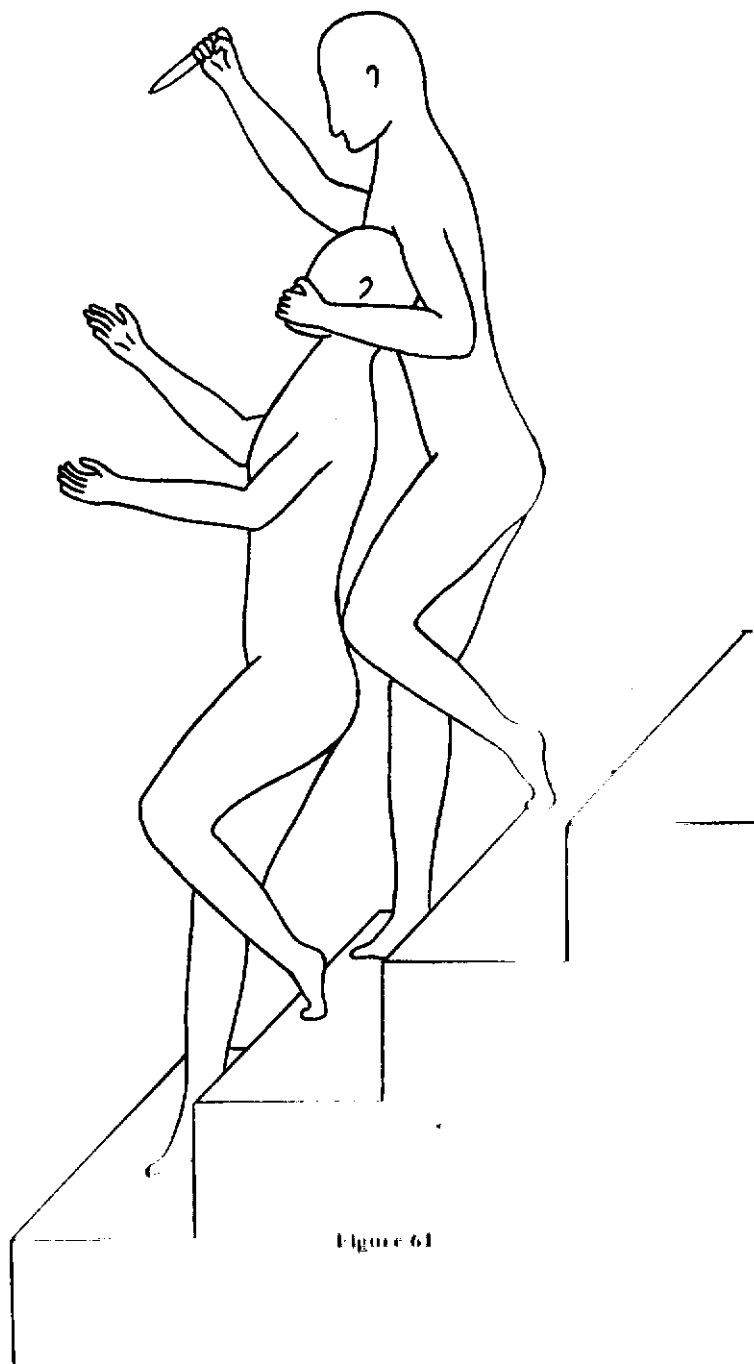

Figure 61

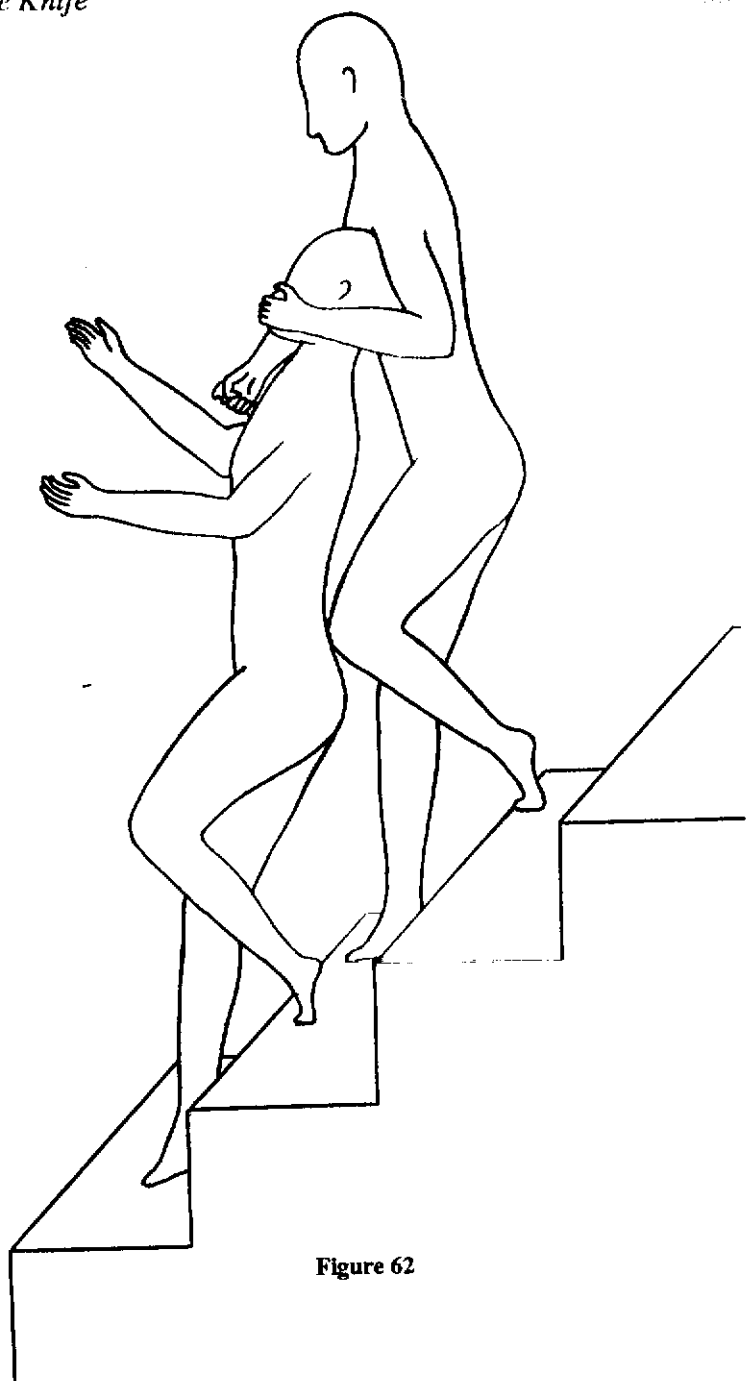

Figure 62

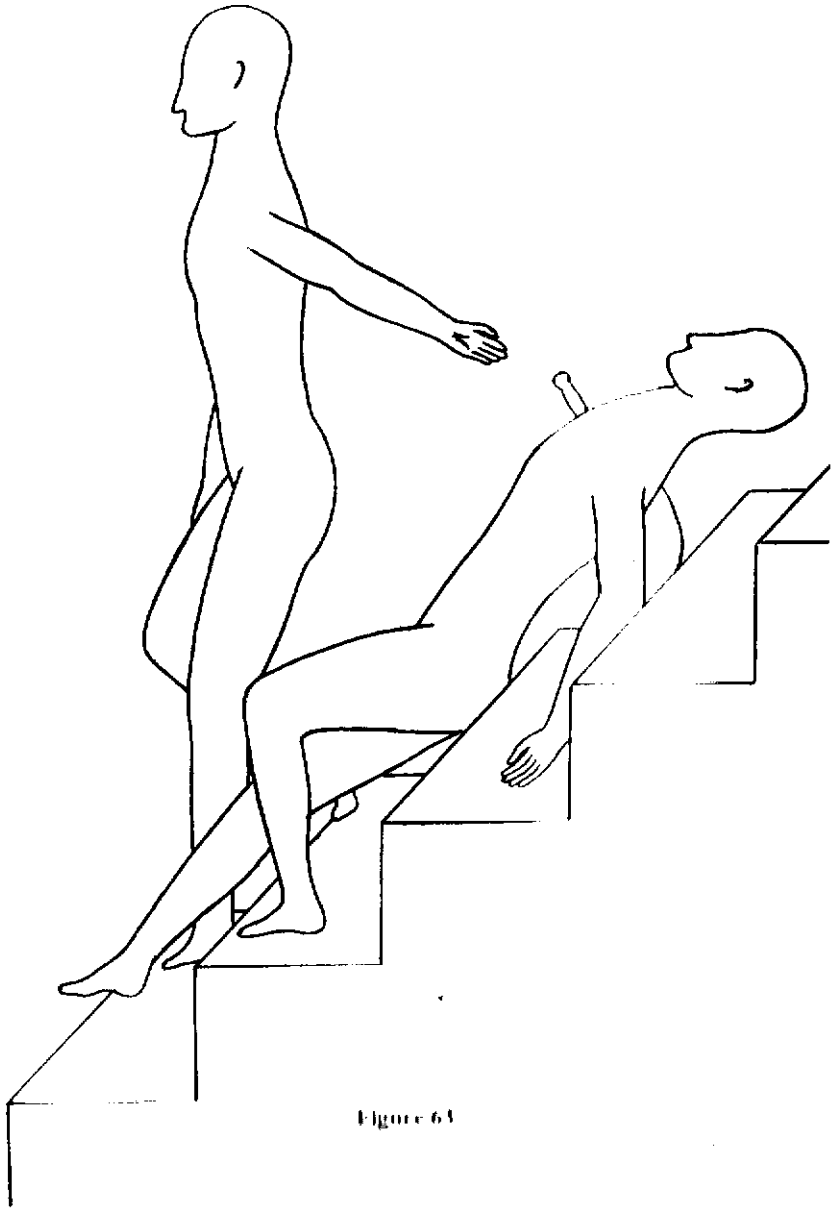

Figure 63

Anatomical targets and locations are changing for this sequence. The target area is the heart, and this hit will be pulled on a staircase.

In Figure 59, the assassin has moved in behind his target and is following him down a staircase. He takes a quick step down to close the gap between them and clamps the victim's mouth while raising his knife (Figure 60). He pulls the target's head back to his left side, pressing it against his left pectoral muscle and shoulder (Figure 61). This pulls the victim off balance as well as prevents him from yelling upon impact of the thrust. The attacker slams the point of the blade through the sternum and into the heart (Figure 62). Remember, he is attempting to penetrate a strong cartilaginous structure, so he must use maximum force. He pushes the target off his left side and continues down the staircase, as depicted in Figure 63.

Technique 11

Again the executioner approaches the target from the rear and attacks the heart, but in this sequence the target is seated.

When close enough to his target, the attacker draws his weapon and is ready for a quick grab on the mouth (Figure 64). When he makes contact, he twists the victim's head to the side and raises his knife for the thrust (Figures 65 and 66). As with previous techniques, this turn of the head is accomplished with the initial grab—they are not two separate movements. With the target's head tucked against his abdomen, the assassin thrusts the knife through the

sternum and into the heart (Figure 67). Without hesitating, he turns away and walks toward his exit point (Figure 68).

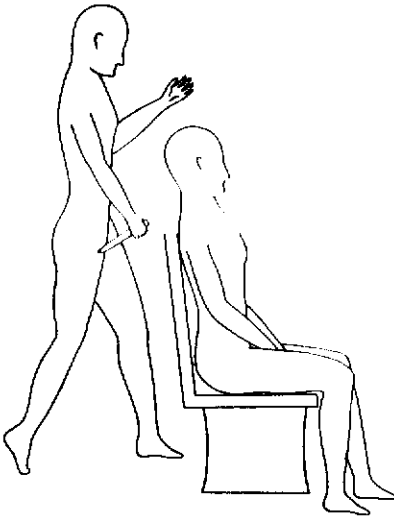

Figure 64

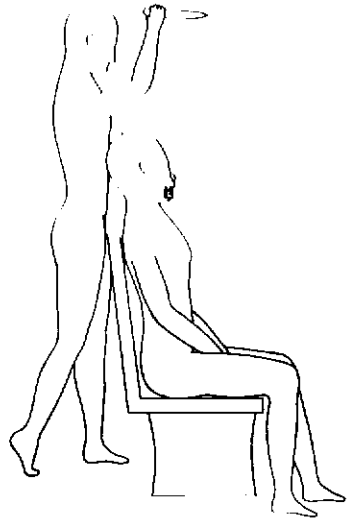

Figure 65

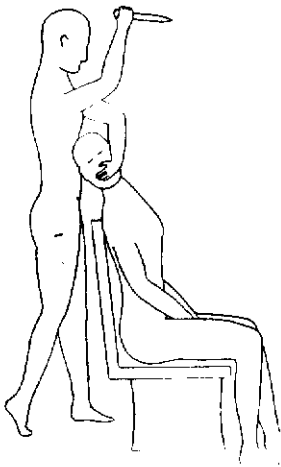

Figure 66

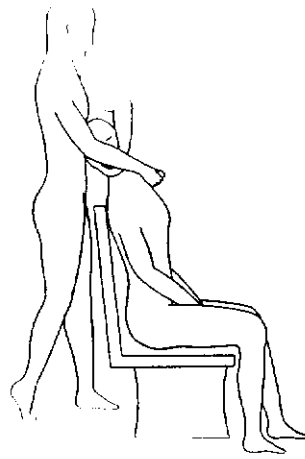

Figure 67

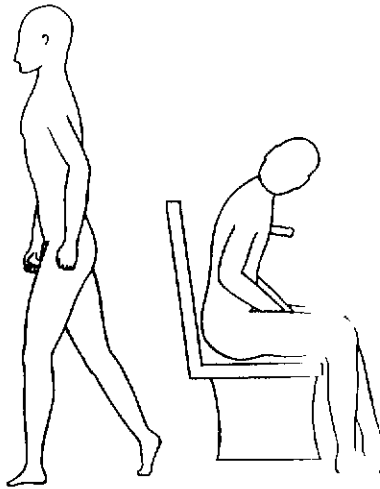

Figure 68

Technique 12

In this sequence, the assassin attacks the substernal notch, approaching the target from a very natural direction for this type of attack—coming up a staircase. The technique is simple, quick, and deadly.

For this technique, the weapon should be sheathed point-up under the assassin's shirt (which would *not* be tucked into his pants), or it can be hidden under a loose-fitting jacket. As he approaches the target, he reaches back and draws the knife. The attacker should leave the weapon hand behind his back, as if he were allowing the target enough room to pass (Figure 69). As he passes, the assassin thrusts the knife at an upward angle into the substernal notch (Figure 70).

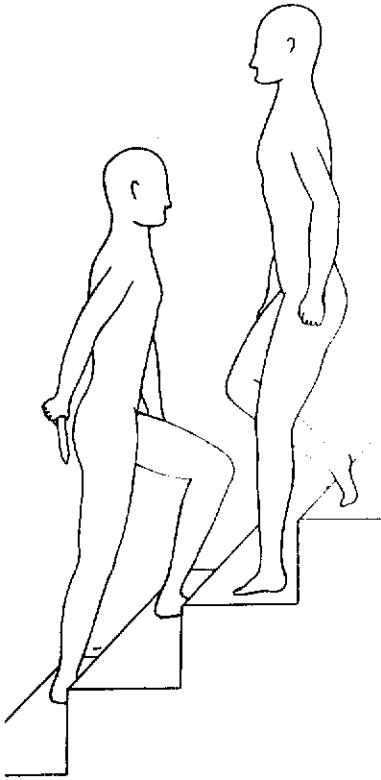

Figure 69

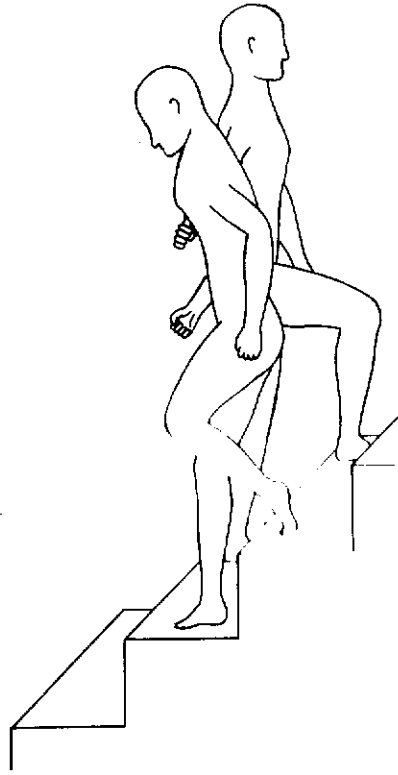

Figure 70

The executioner should never have to break his stride up the stairs. With practice, the movement can be smoothed out to look so natural that even if the target were looking right at the assassin, he couldn't anticipate the attack. As he is falling down the stairs, the assassin should continue walking up the stairs at his normal pace and should not look back (Figure 71).

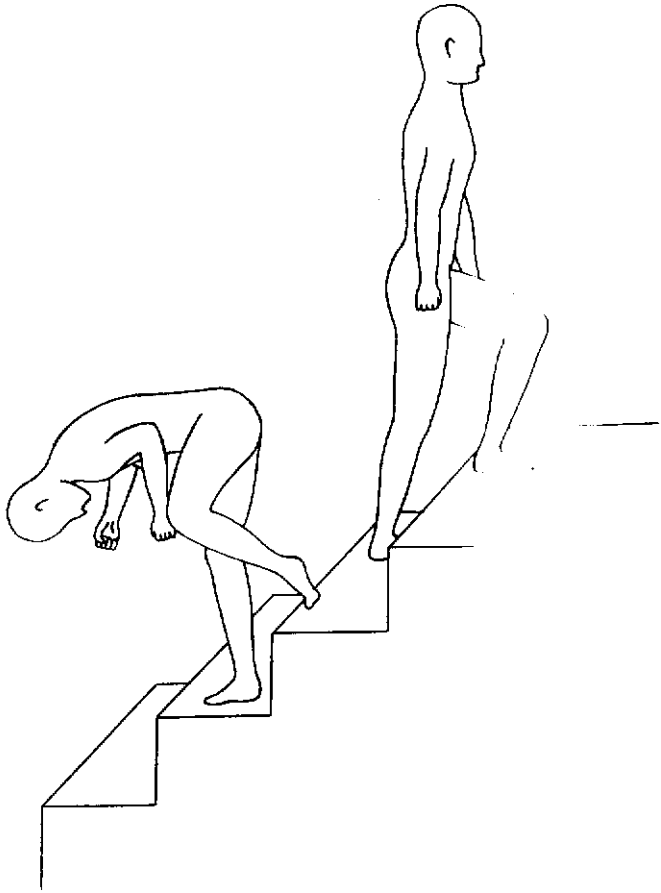

Figure 71

Technique 13

The target area for this sequence is the suprasternal notch. The attacker approaches a seated target from his left side.

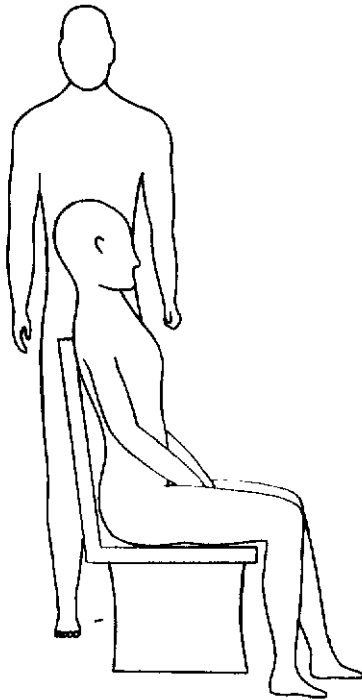

Figure 72

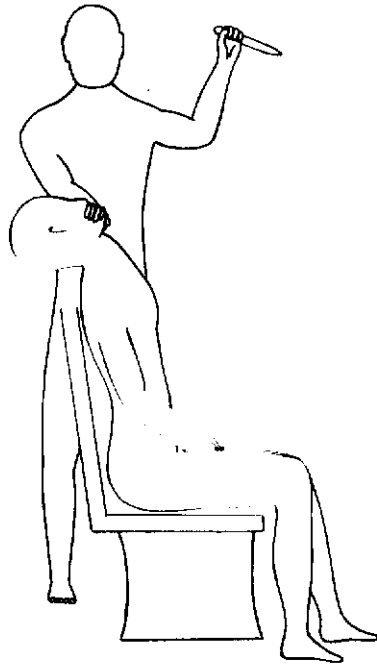

Figure 73

In Figure 72, the assassin approaches the victim with the weapon drawn and hidden in his left hand. The clamp on the victim's mouth is thumb-down this time, but, unlike the thumb-down clamp technique in Chapter Two, it is not necessary to put pressure under the chin. He should simply keep a firm grip over the target's mouth and pull his head back to expose the suprasternal notch (Figure 73). With a powerful downward thrust, the assassin buries the length of

the blade into the suprasternal notch, as shown in Figure 74. He releases the mouth grip and walks directly away from the target (Figure 75).

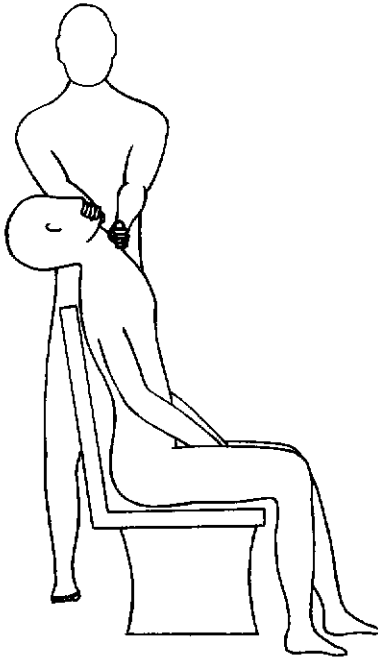

Figure 74

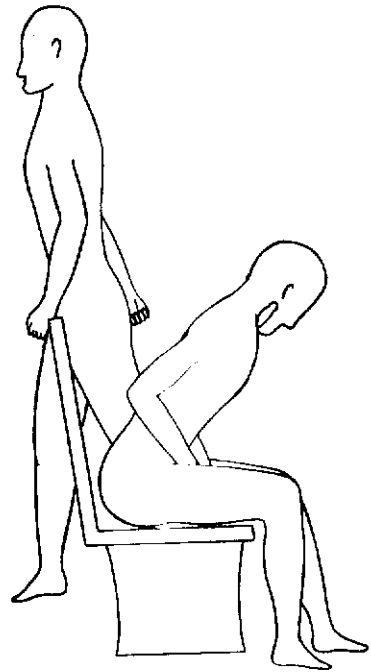

Figure 75

Technique 14

In this final sequence of Chapter Three, the assassin attacks two vital areas—the front and side of the neck—with a one-stroke combination movement.

As shown in Figure 76, the assassin approaches a seated target from the rear with his weapon drawn. He brings the knife close to the victim's head as he clasps his hand over his mouth (Figure 77). Rotating the target's head fully to the right, he places the cutting edge of the blade against the

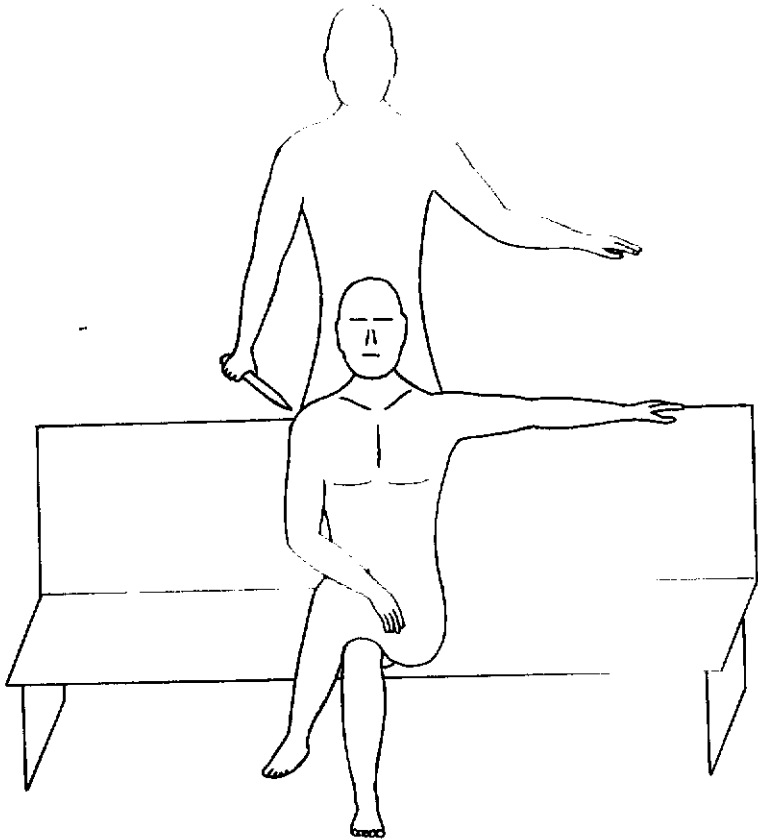

Figure 76

left side of his neck (Figure 78). He presses the knife hard against the neck and drags the cutting edge of the blade across the left side, front, and right side of the neck while rotating the head in the opposite direction, as shown in Figure 79. He releases the victim, drops the knife, and walks toward his predetermined exit (Figure 80).

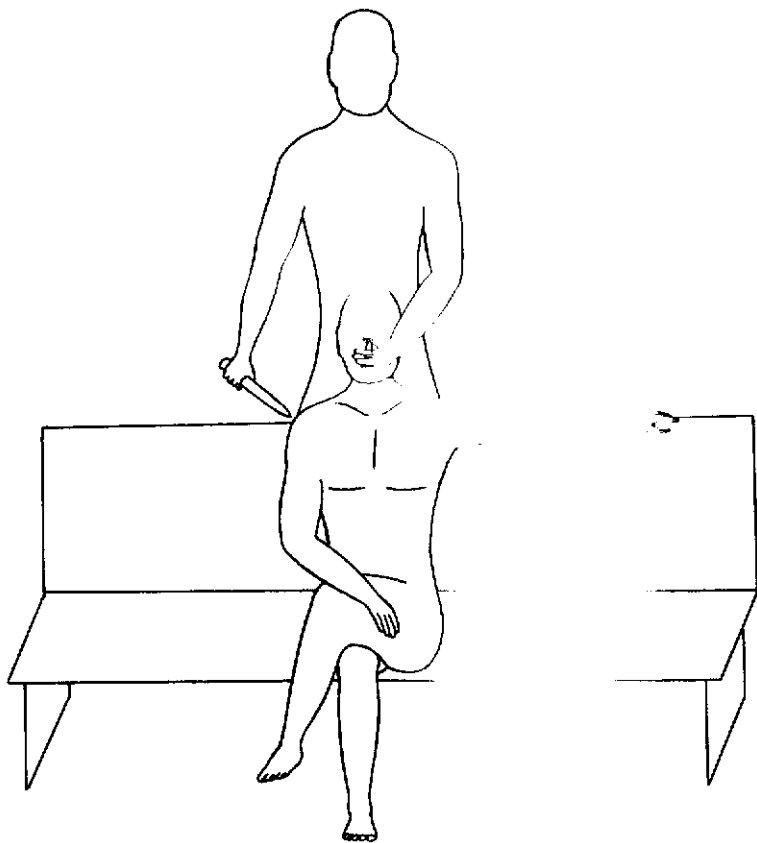

Figure 77

This technique raises two important points. The first and most important point is that this attack is likely to spray blood in a 180-degree radius for about four feet. Needless to say, the assassin is going to get blood on both his hands (at the very least).

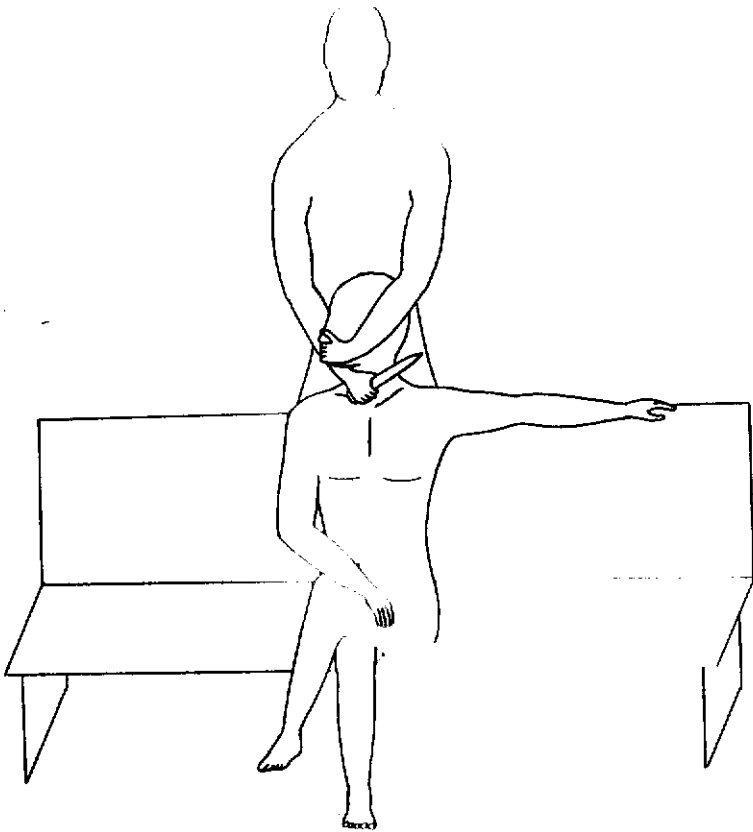

Figure 78

Second, if you look back at every previous technique in this book, you will notice that the weapon has always been left lodged in the target as the executioner exited the area. This is not the case with this technique, unless he were to

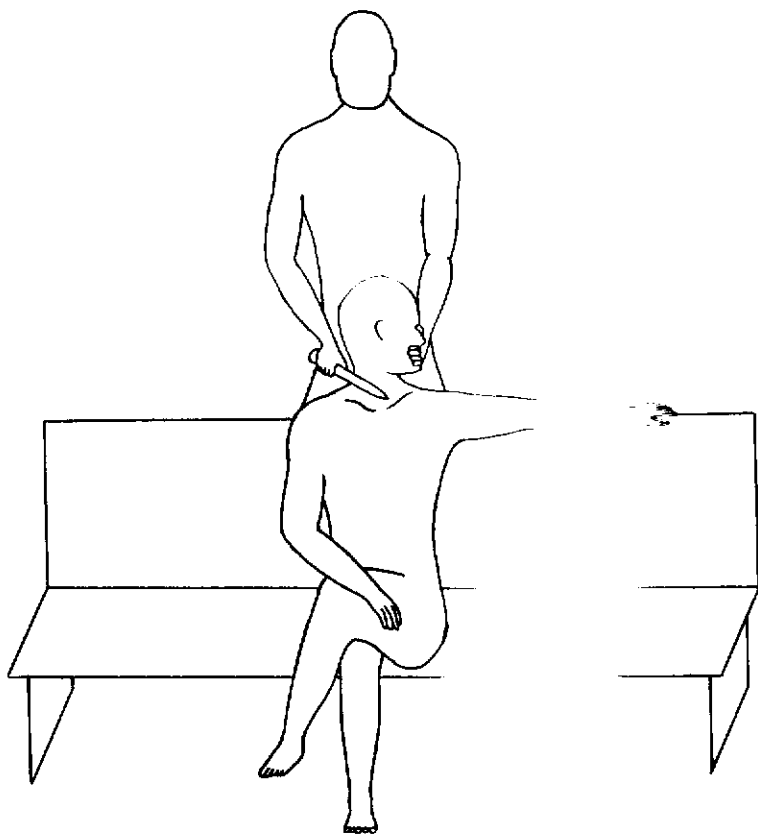

Figure 79

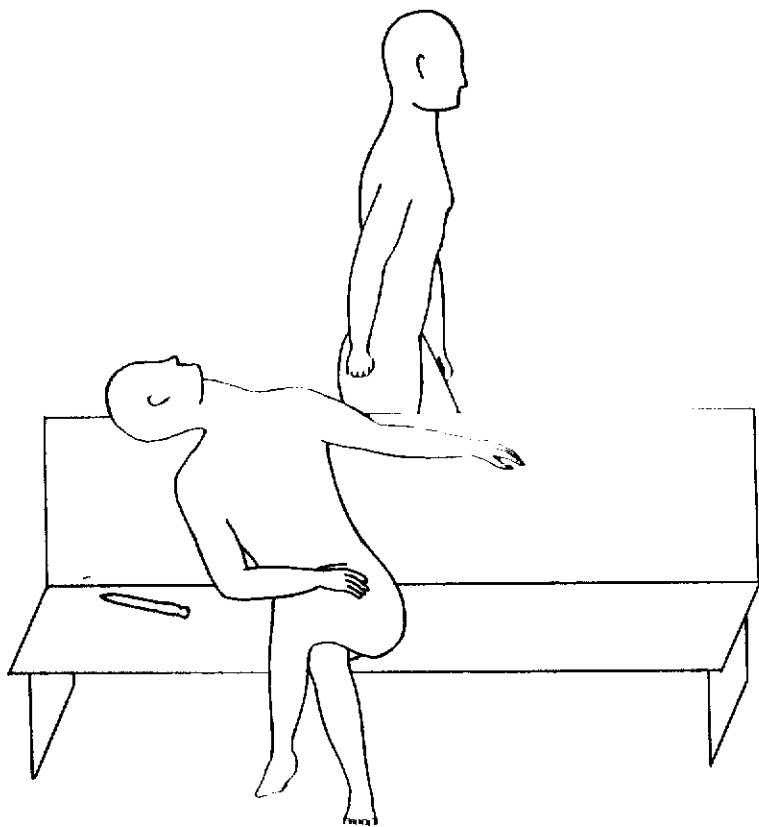

Figure 80

add a second puncturing stroke. If he does not, then he *must not* carry the weapon with him—he should drop it as he leaves. Steel leaves a residue on the skin that can be

identified by forensic techniques. If the assassin were to be captured with the weapon, it would be enough evidence for any court in the world to find him guilty of murder. He must not carry the weapon with him!

Chapter Four

The Nunchaku

Before discussing the technical applications of the nunchaku for silent killing, a brief study of grips and releases is needed.

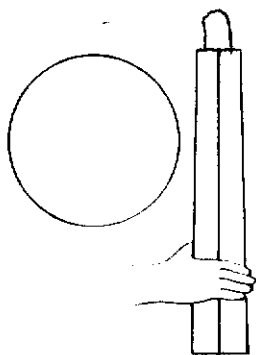

Figure 81

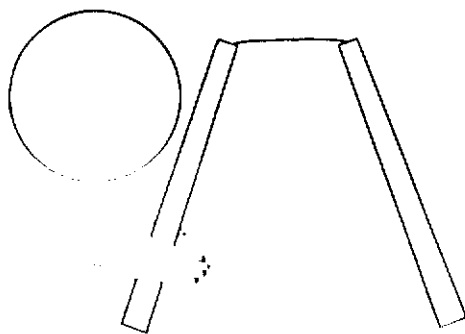

Figure 82

Observe Figure 81. Notice that the sticks are gripped at the wide ends, away from the cord. It is not necessary to hold a stick in each hand in order to wrap it around an opponent's neck. The sticks can be *swung* into position with an accurate swing and catch. It is every bit as fast as two-handed techniques and, in certain cases, it is the preferred method to get the weapon into position.

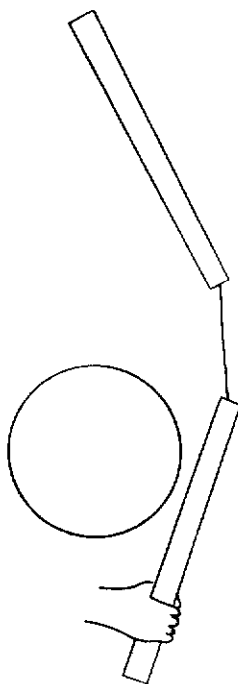

Figure 81

The following technique will get the sticks around a target's neck from the rear. With the sticks held parallel to the floor, start a swinging movement with the arm and

release the outer stick by opening the fingers (Figure 82). Maintain a tight grip on the other stick by grasping it in the deep pocket between your thumb and the first knuckle of the index finger. As the outer stick swings around to the other hand, clamp your fingers firmly around the end (Figure 83).

When the stick circles the target's neck, open the receiving hand wide and let it strike the palm of your hand (Figure 84). When you feel the contact, close your hand around the stick and turn your palm upward, as shown in Figure 85. This turning of the palm will clarify itself when you begin studying the techniques in this chapter. For the moment, we are concerned with how the stick is released. Note that with this release, the thumb rests on the inside of the stick.

Now look at Figure 86. Here the thumb is toward the outside of the stick, and consequently a different release will be required. To get to the position depicted in Figure 87, you again must initiate a centrifugal-force motion by swinging your arm in a parallel plane with the floor. Open the thumb and allow the outside stick to move with the centrifugal force you created with your arm movement, at the same time squeezing your other fingers to hold the inner stick. The swinging stick will pass along the underside of your arm on its way around the target's neck (Figure 88).

Open the receiving hand palm down. When the stick strikes your hand (Figure 89), grasp it firmly. Figure 90 illustrates the final position of the nunchaku around the target's neck.

In Figure 85, one palm faces up and the other down. In Figure 90, both palms are down. Determining which grip to utilize when performing a silent kill technique is a matter of

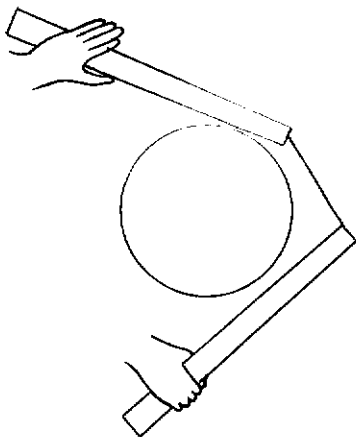

Figure 84

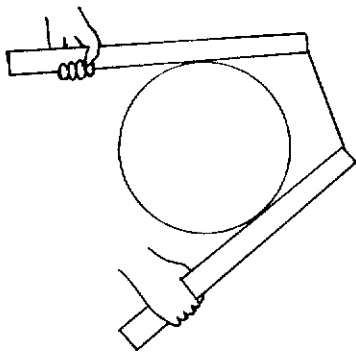

Figure 85

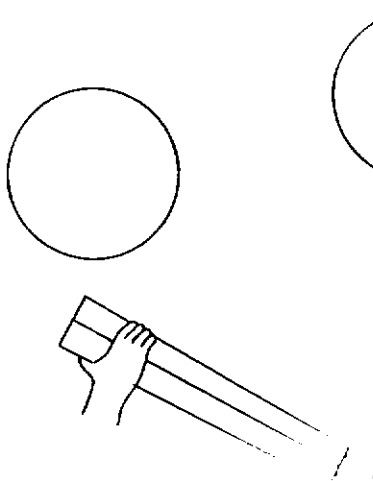

Figure 86

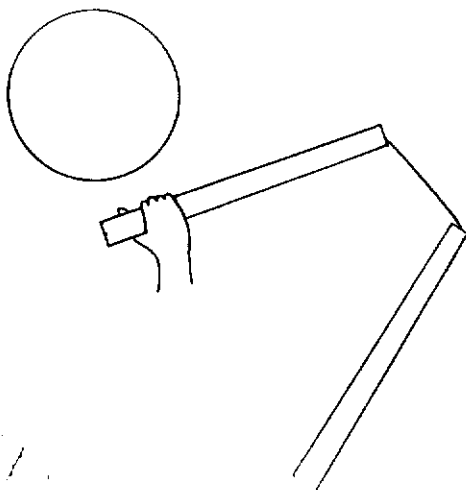

Figure 87

personal preference and comfort for the assassin. They are each equally effective, and their differences will be pointed out as each grip is used in the techniques in this chapter.

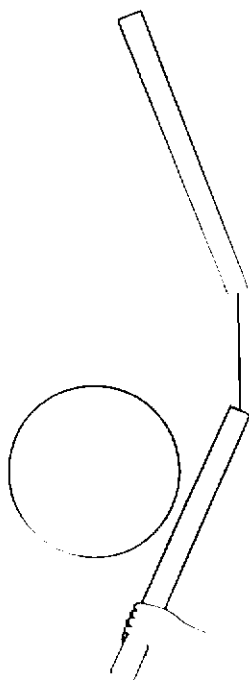

Figure 88

Regardless of which release and catch the assassin prefers, he must practice both repeatedly until he can perform them blindfolded at lightning speed. He should practice around a pole or similar object to simulate going around a neck and completing the compression movement.

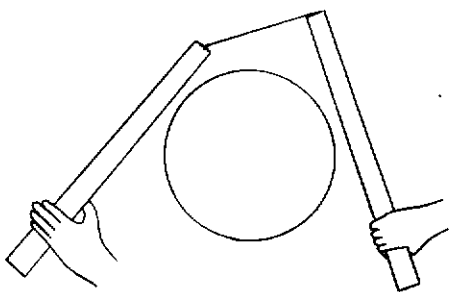

Figure 89

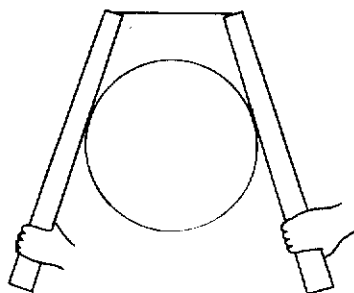

Figure 90

Technique 15

The first few techniques are simple ones that do not require a release. As they will demonstrate for themselves, however, they are no less deadly.

Figure 91 shows the assassin approaching his target from the right side using a double palm-in grip on the nunchaku. He leans forward as far as necessary and slips the weapon over the target's head (Figure 92). As soon as the sticks are in line with his neck, the attacker steps back slightly and compresses them together as hard as he can (Figure 93).

It takes about ten seconds to completely incapacitate a target using the strangling method illustrated in this sequence. During this time, he may very well go into a traumatic state of fear and attempt to struggle loose. In anticipation of this, the assassin should train himself to hold

his own arms rigid. The position they are in at the moment he applies pressure is the distance at which they should remain until he drops the sticks and leaves the scene.

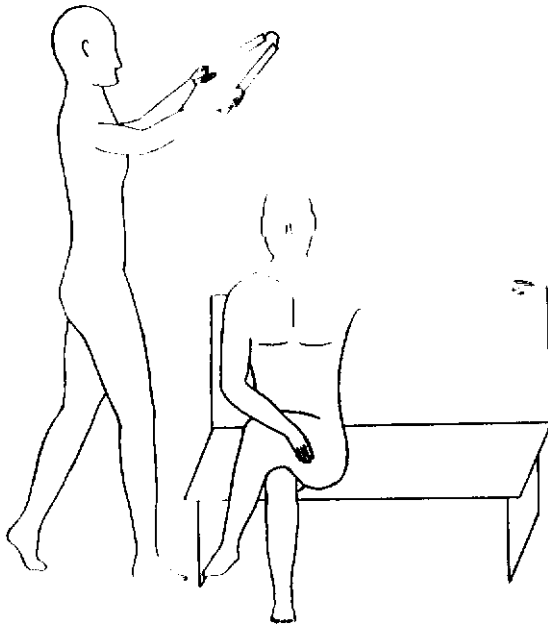

Figure 91

When the neck is compressed with a nunchaku in this fashion, several physiological effects will be evident. First, the victim will not be able to yell. His trachea and esophagus will be tightly compressed, so no air and thus no sound will be able to pass through his mouth. Secondly, the cartilaginous rings of the trachea will be broken, which will puncture holes in the windpipe and cause irreparable

damage. Blood will immediately begin to flow into the lungs and stomach. Blood pressure will soon drop below the life-sustaining level because of the massive hemorrhaging. In addition, the cervical vertebrae will break. When this happens, the assassin will feel a vibration in the sticks and hear a high-pitched crack followed by multiple deep thuds when the cervical vertebrae separate.

These effects will accompany all compression techniques with the nunchaku. Once full-power compression has been applied, there is no chance of the target surviving.

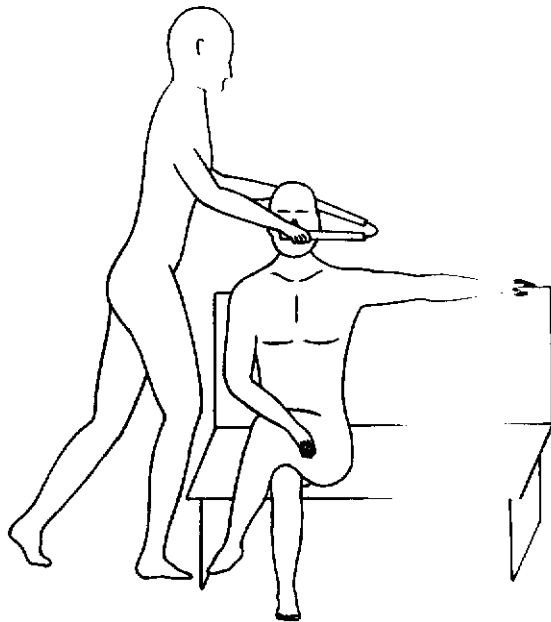

Figure 92

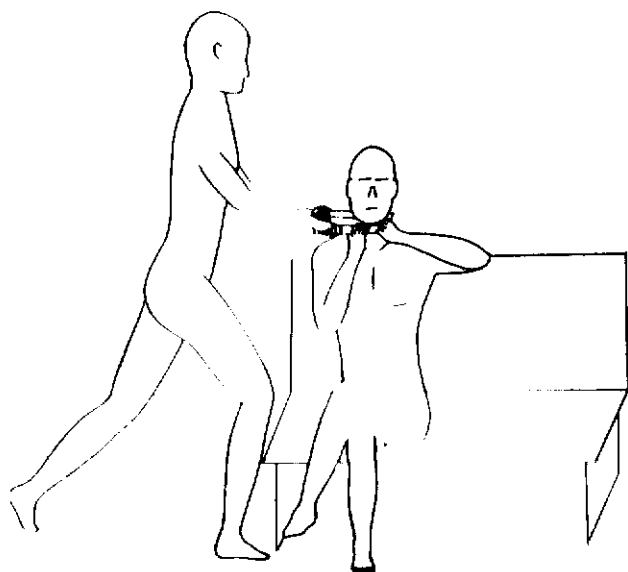

Figure 93

Technique 16

This technique is also performed without a release, and it utilizes a double palm-down grip during compression.

Figure 94 shows the assassin approaching the target from the rear. Note that the sticks form a 90-degree angle, as further illustrated in Figure 95. The attacker reaches over the target's head and aligns the lead stick to press across the front of his neck (Figure 96).

The assassin started this technique with one palm facing in (Figures 94 and 95). Figure 97 shows him now using a double palm-down compression technique. To achieve this position, after slipping the sticks over the target's head, the attacker rotates the stick between his index and middle finger as he is on the way down to the clamping area of the neck. This should be done as he passes the ear. It will be difficult at first, but practice will enable him to perform this movement quickly and smoothly.

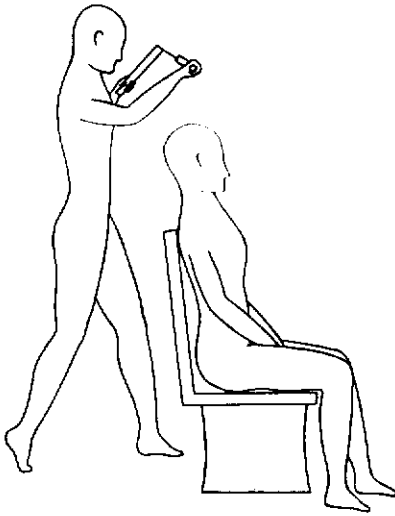

Figure 94

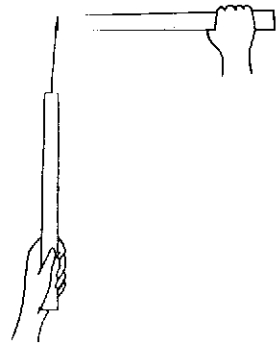

Figure 95

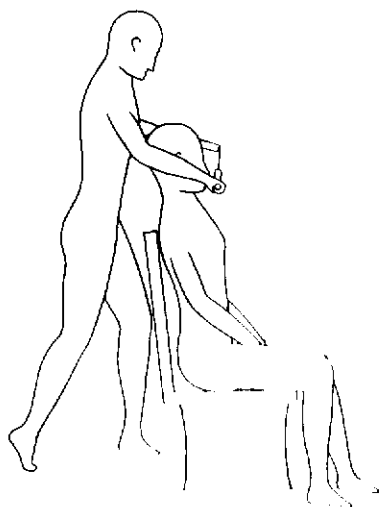

Figure 96

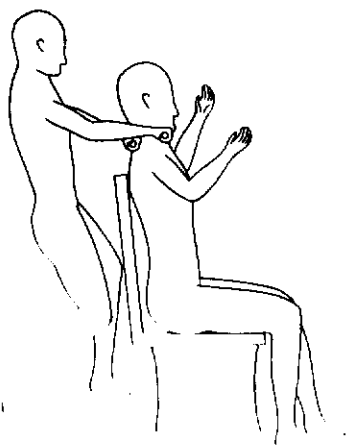

Figure 97

Technique 17

This is probably one of the most unorthodox applications of the nunchaku, but it works so well under the right circumstances that it warrants mention.

The assassin approaches a seated target (Figure 98) with his hands firmly holding both sticks together, as illustrated in Figure 99. He slips the sticks over the target's head and locks them up against his neck (Figure 100). The attacker then raises his knee and places it on the back of the victim's neck (Figure 101). Using arm and lower-back power, he should try to pull the sticks clean through the target's neck until they hit his kneecap. This will not happen, of course,

but in this position, he can use his lower back muscles to increase the overall pressure against the target's neck, giving the compression tremendous power.

An assassin should only use this technique when his target is seated. The victim's shoulders have to be blocked against the back of the bench or he might be able to roll to the side (even by accident) and the assassin would lose his grip on his neck.

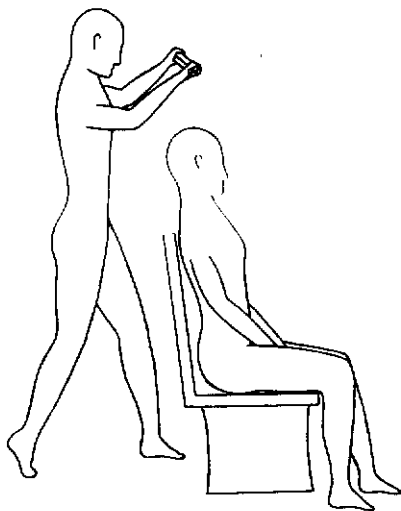

Figure 98



Figure 99

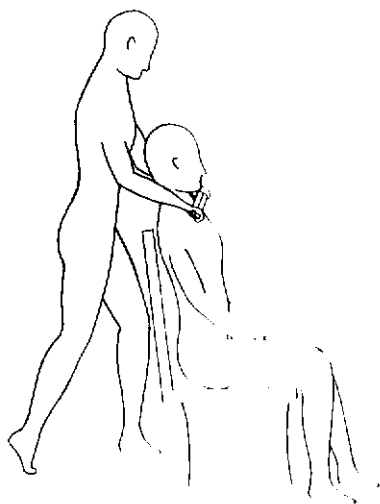

Figure 100

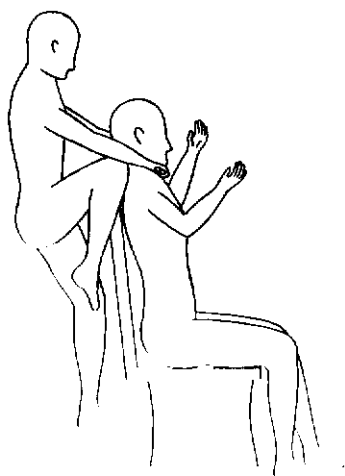

Figure 101

Technique 18

This technique will challenge the assassin's skills. We will illustrate an inside release and a double palm-in grip during compression.

The executioner is stationary as the target approaches from his right side (Figure 102). As he gets to the point depicted in Figure 103, the attacker reaches out to the side and initiates the swing to bring the sticks around his neck. At the last possible moment, he extends his left hand to catch the incoming stick (Figure 104). As he catches it, he spreads his stance slightly in preparation for the initial struggle (Figure 105). Turning both palms inward, the

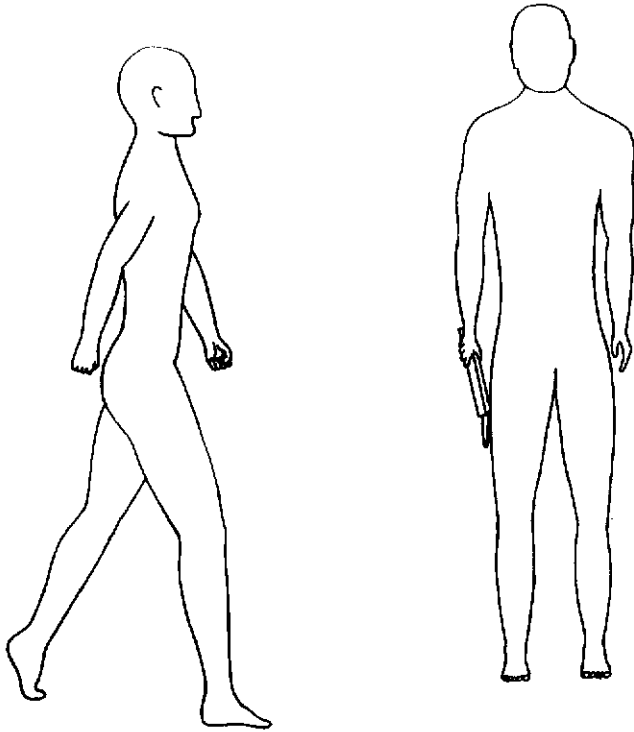

Figure 102

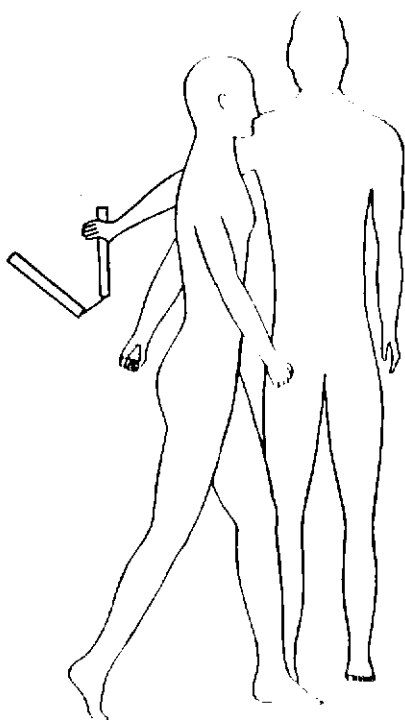

Figure 103

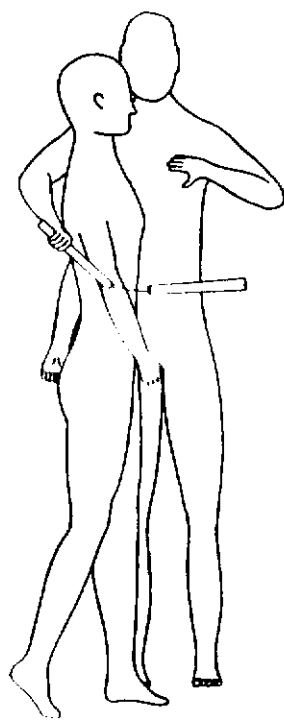

Figure 104

assassin squeezes the nunchaku together with full power (Figure 106), keeping his arms rigid at the elbows and shoulders. Ten seconds of full-power compression will be sufficient to kill the target.



Figure 105

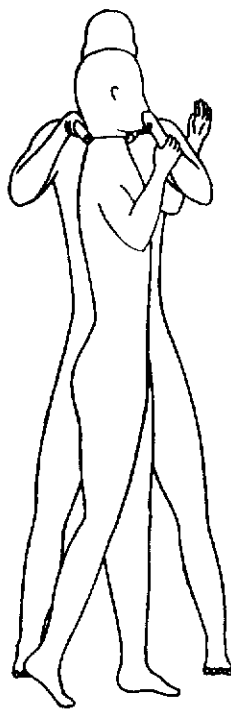

Figure 106

Technique 19

In this sequence, the assassin approaches the target from the rear while he is walking. He will use an outside release with a double palm down compression technique.

His previous practice and experience should help the assassin judge the proper distance between himself and the

target (Figure 107). At the last moment, he closes the gap while swinging the stick out and around the victim's neck (Figure 108). Note the position of the stick and the right hand in Figure 109. It is held at the target's right side, while the loose stick is caught to the left of the target's head. The assassin brings his right hand across his body to his left shoulder and sets the loose stick across the front of the target's neck (Figure 110). He clamps down firmly.

Again, the attacker should anticipate a brief struggle (Figure 116). He must be sure to hold the arms rigid while applying full compression power.

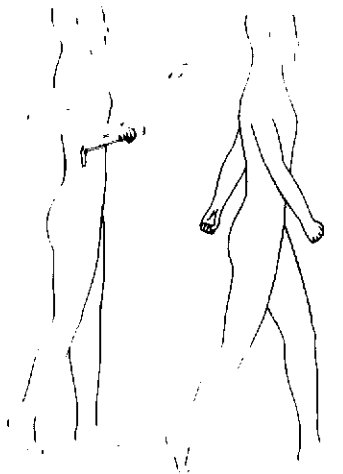

Figure 107

The victim may very well make a desperate attempt to get away for a few seconds, but it will be a brief struggle. As a rule, he will use one or both hands to try to pull the sticks off his neck, as shown in Figure 111. The assassin should expect this reaction and maintain maximum pressure while keeping his arms rigid.

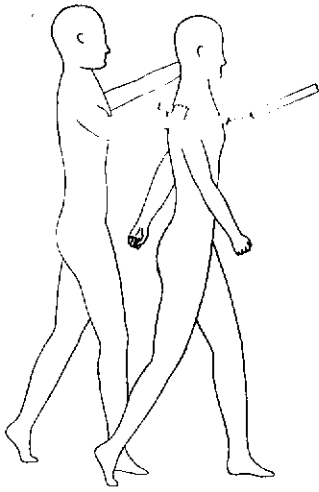

Figure 108

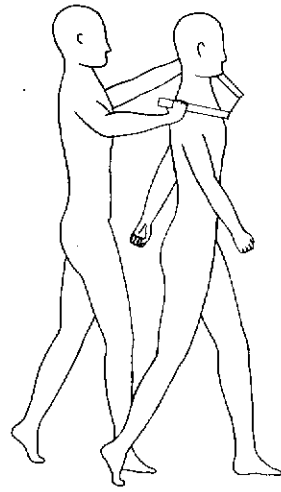

Figure 109

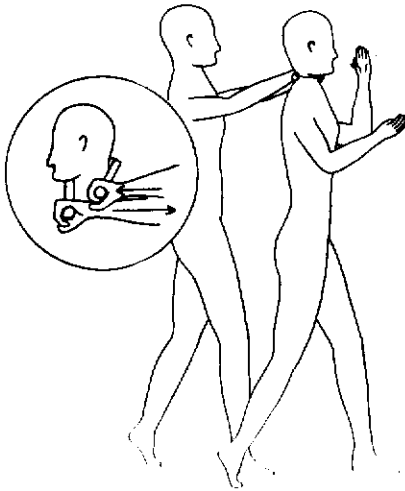

Figure 110

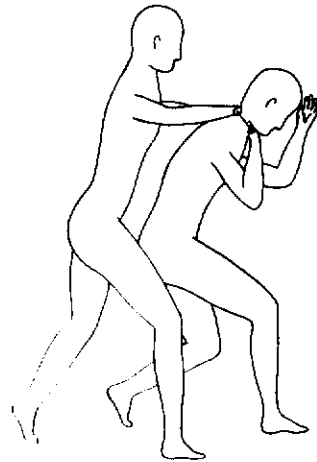

Figure 111

Technique 20

In the previous sequence, the assassin used an outside release and applied compression with a double palm-down grip. In this sequence, he uses an inside release and applies a one-up and one-down compression technique.



Figure 112

Figure 112 shows the executioner using the same approach as in the previous technique, but note that the nunchaku is being held for an inside release. He closes the gap with a quick step and swings the weapon out and over

the target's shoulder toward the opposite side of his body (Figure 113). Catching the stick slightly above shoulder height, the assassin immediately twists his palm upward (Figure 114). As he twists the palm of his receiving hand, he brings it to the right side of his body and clamps the sticks together (Figure 115). Note that unlike the previous technique, the left palm is facing up.

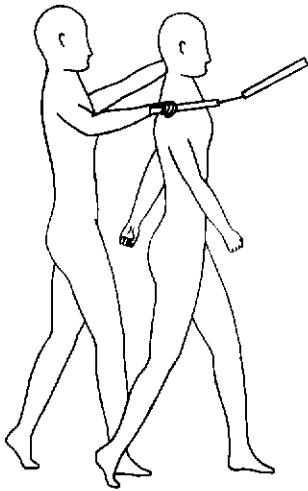
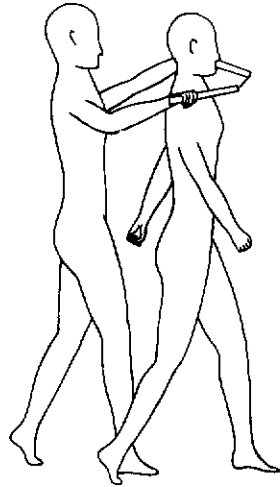
**Figure 113****Figure 114**

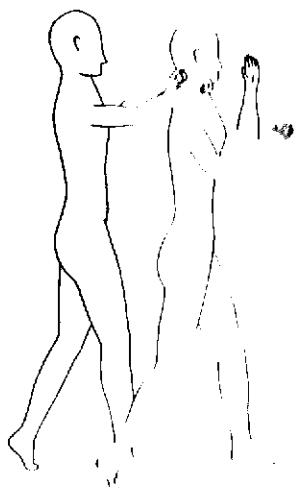

Figure 115

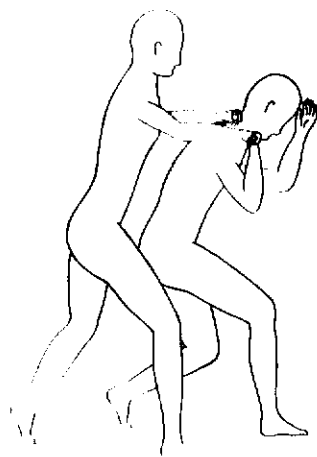

Figure 116

Technique 21

In this final sequence, the assassin approaches his target from the rear. He uses an inside release and a palm-up/palm down compression technique.

When the attacker has closed the distance between him and his target, he takes the sticks in preparation for the swing (Figure 117). As the stick travels to the opposite side of the target's body, the assassin reaches for it by placing his hand in an intercepting position (Figure 118). When the stick strikes his hand, he closes it and turns his palm upward (Figure 119). He then crosses his left hand to the right side of his body to complete the movement and clamps the sticks together with the greatest possible force (Figure 120).

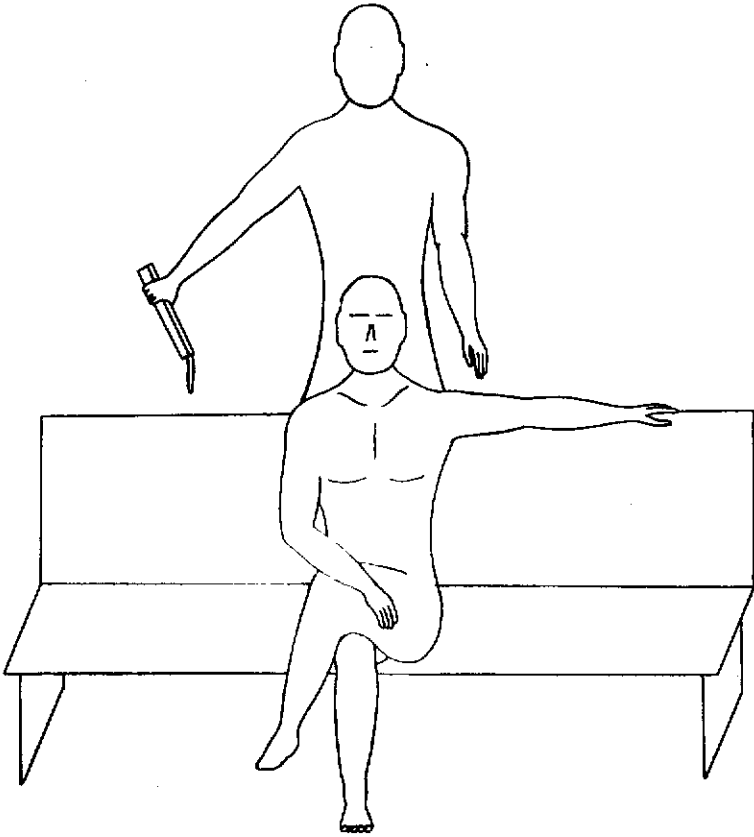

Figure 117

Again, the assassin should be prepared for a brief struggle (Figure 121). He must keep his arms rigidly extended during this and all compression techniques with the nunchaku.

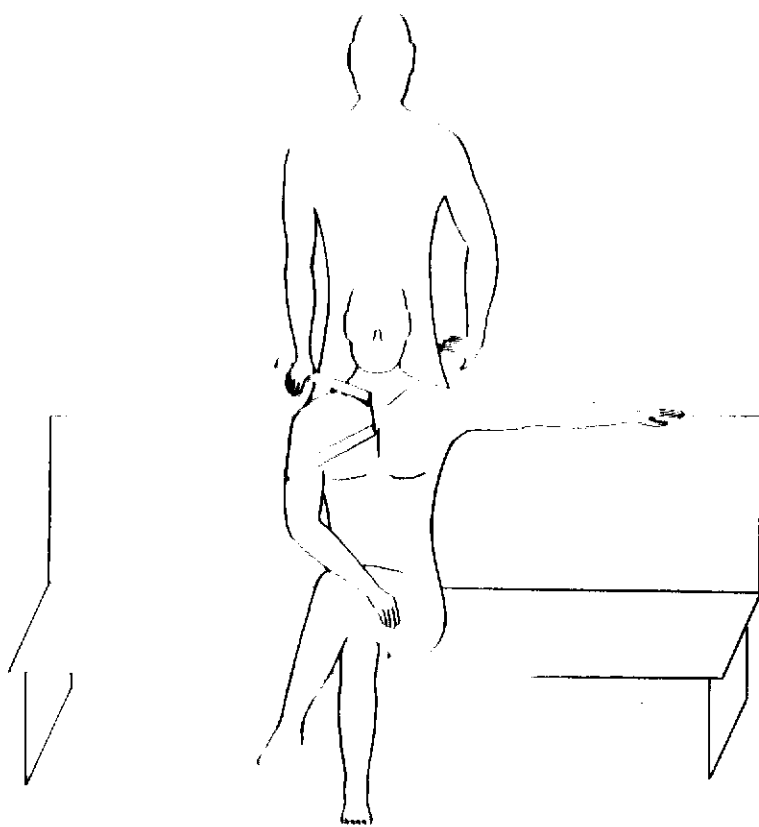

Figure 118

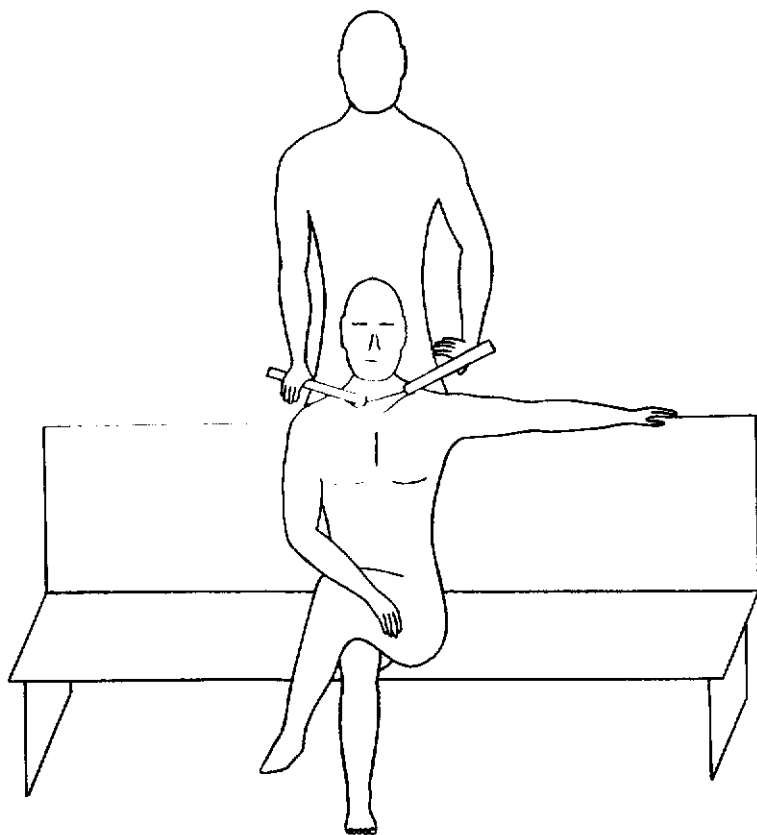

Figure 119

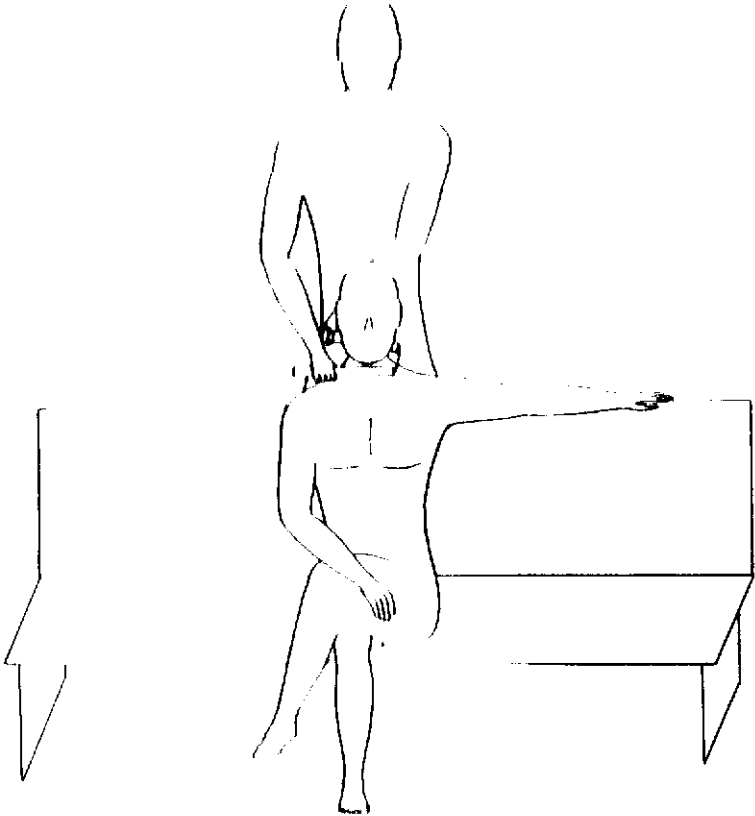

Figure 120

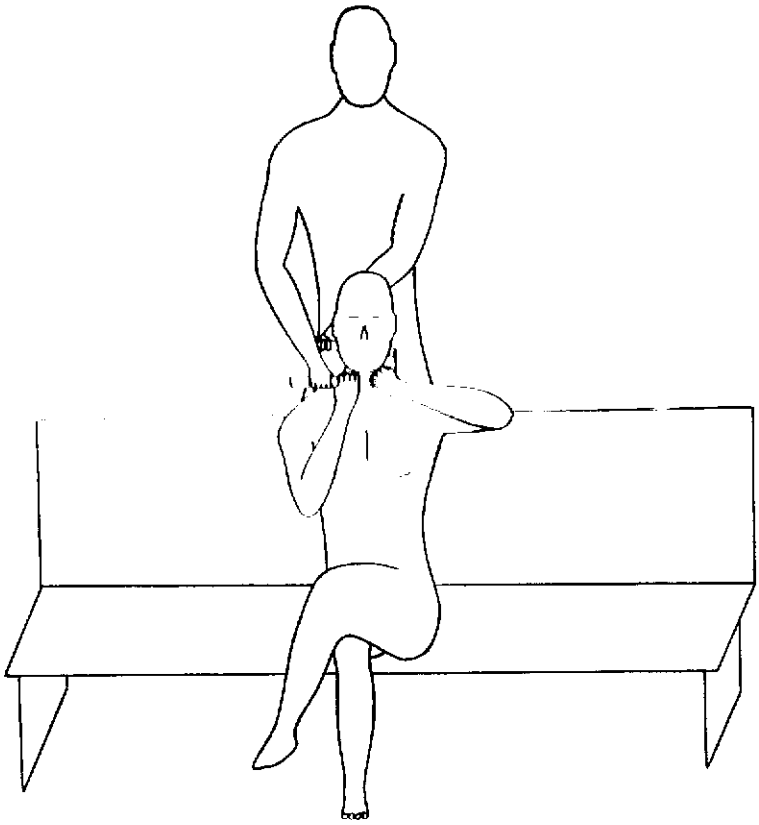

Figure 171

Conclusion

The techniques in this book have been designed for a single purpose—execution. These are not self-defense maneuvers. An assassin should not use them with any preconceived notion that they will simply stop an aggressor. They are designed to kill, and they will kill and nothing less. If the assassin does not intend to kill his target, he should use techniques from another text.