

The Book of Sitra Achra

A Grimoire of the Dragons of the Other Side



N. A. A. 218

The Book of Sitra Achea

⌘ A Grimoire of the Dragons of the Other Side ⌘



The Book of Sitra Achea

⌘ A Grimoire of the Dragons of the Other Side ⌘

The first edition of The Book of Sitra Achra was published on 11.11.2013 in an amount of 777 copies. Additional special editions of 110 gilded and slipcased copies, a Deluxe Edition of 61 books bound in snakeskin delivered in a special book box and 11 Talismanic Copies bound in goat and snakeskin were privately distributed, with each of those 11 Talismanic Books being dedicated and enlinked to one of the Heads of Azeraté.

All Texts, Symbols and Seals © 2013 N.A-A.218
First Edition © 2013 Ixaxaar Occult Literature



All rights reserved.

No part of this book may be reproduced or utilized in any form or by any means, electronic or mechanical, without the written permission from the author and copyright owner.

Table of Contents

<i>Introduction</i>	11
<i>1. The Sitra Achra and the Serpents of the Thoughtless Light</i>	14
<i>2. El Acher – The Other God</i>	23
<i>3. The Qliphoth of the Tree of Death</i>	30
<i>1. Thaumiel</i>	30
<i>2. Aogiel/Ghagiel</i>	32
<i>3. Satariel</i>	34
<i>4. Gash Khalah</i>	36
<i>5. Golachab</i>	38
<i>6. Thagirion</i>	40
<i>7. Oreb Zaraq</i>	42
<i>8. Samael</i>	44
<i>9. Gamaliel</i>	46
<i>10. Nahemoth</i>	48
<i>4. The Eleven Heads of Azerate</i>	52
<i>Satan</i>	58
<i>Molok</i>	60
<i>Beelzebub</i>	62
<i>Lucifuge Rofocale</i>	64
<i>Astaroth</i>	66
<i>Asmoday</i>	68
<i>Belfegor</i>	70
<i>Baaltzelmoth</i>	72
<i>Adramelek</i>	74
<i>Lilith</i>	76
<i>Nabemah/Naamah</i>	78

<i>8. The 60 Emissaries of the Black Light</i>	80
<i>Thaumiel's Seven Emissaries of the Name</i>	84
1. Thaninel	84
2. Akzarel	85
3. Uazarel	86
4. Mibdalabel	87
5. Ianabel	88
6. Abadel	89
7. Labbabel	90
<i>Aogiel's Six Emissaries of the Name</i>	91
1. Abedabel	91
2. Okuroel	92
3. Gebel	93
4. Iashamel	94
5. Acharel	95
6. Laabel	96
<i>Satariel's Eight Emissaries of the Name</i>	97
1. Sathamel	97
2. Ayomel	98
3. Taalumabel	99
4. Aphelabel	100
5. Radabel	101
6. Irabtzal	102
7. Ashmanel	103
8. Laatel	104
<i>Gash Khalab's Six Emissaries of the Name</i>	105
1. Gadael	105
2. Akalel	106
3. Shararel	107
4. Kaphabel	108
5. Lachamel	109
6. Haragel	110
<i>Golachab's Five Emissaries of the Name</i>	111
1. Gophriythel	111
2. Ophiseshel	112
3. Labatel	113
4. Charchurel	114
5. Balael	115
<i>Thagirion's Seven Emissaries of the Name</i>	116

1. Towebabel	116
2. Gaownel	117
3. Ramamel	118
4. Igedael	119
5. Rahabel	120
6. Oriensel	121
7. Natashel	122
<i>Oreb Zaraq's Six Emissaries of the Name</i>	123
1. Ongirtael	123
2. Ratsachel	124
3. Bazarel	125
4. Zabachel	126
5. Rabel	127
6. Qeberel	128
<i>Samael's Four Emissaries of the Name</i>	129
1. Salaphel	129
2. Maradel	130
3. Ayabel	131
4. Lachatsel	132
<i>Gamaliel's Six Emissaries of the Name</i>	133
1. Gadaphel	133
2. Maarabel	134
3. Lachasbel	135
4. Iatsathel	136
5. Arvabel	137
6. Layilel	138
<i>Nahemoth's Five Emissaries of the Name</i>	139
1. Neqamabel	139
2. Hamabel	140
3. Mirshaathel	141
4. Atadel	142
5. Tazazel	143
<i>6. The 22 Silencing Letters of the Other Side</i>	149
1. Aleph	151
2. Beth	152
3. Gimel	153
4. Daleth	154
5. Heb	155
6. Vav	156

7. Zayin	157
8. Cheth	158
9. Teth	159
10. Yod	160
11. Kaph	161
12. Lamed	162
13. Mem	163
14. Nun	164
15. Samekh	165
16. Ayin	166
17. Peh	168
18. Tzaddi	169
19. Qoph	170
20. Resh	171
21. Shin	172
22. Tav	173
7. <i>The 12 Princes of the Qliphothic Zodiac</i>	176
1. Ba'airiron	178
2. Adimiron	180
3. Tzalalimiron	182
4. Shichiron	184
5. Shalebiron	186
6. Tzaphiron	188
7. A'abiron	190
8. Nechesbiron	192
9. Nechesbiron	194
10. Dagdagiron	196
11. Bahimiron	198
12. Nashimiron	200
8. <i>The Seven Hells and Seven Earths</i>	202
1. Sheol ha-Tehom	208
2. Abaddon	210
3. Tit ha-Yon	212
4. Bar Shachath	214
5. Tzelmoth	216
6. Shaarimoth	218
7. Gehinnom	220
9. <i>The Opening Ritual of the Seven Gates of Hell</i>	228

10. <i>The Star of the Eleven – The Qliphothic Magic of the Hendecagram</i>	239
<i>The Eleven Primal Points</i>	240
<i>The First and Atziluthic Hendecagram</i>	243
<i>The Second and Briatic Hendecagram</i>	245
<i>The Third and Yetziratic Hendecagram</i>	247
<i>The Fourth and Assiatic Hendecagram</i>	249
<i>The Pan-Qliphothic and Unified Hendecagram</i>	251
<i>Practical Applications of the Stars of the Eleven</i>	253
<i>The Invoking/Evoking Hendecagrams</i>	257
<i>The Egressive/Ingressive Hendecagrams</i>	266
11. <i>Building Blocks of a Qliphothic Temple – The Tools of Praxis</i>	271
<i>The Altar-Throne</i>	273
<i>Candle Holders</i>	276
<i>The Kelim-Vessel of Manifestation</i>	277
<i>The Mirror Gates and Srying Bowls</i>	280
<i>The Sacrificial Knife</i>	282
<i>The Twisting and the Straight Wand</i>	284
<i>The Chalice</i>	287
<i>The Bell</i>	289
<i>The Brazier, the Thurible and the Incense of the Art</i>	291
<i>The Cord</i>	304
<i>Blood Sacrifice</i>	307



The Book of Sitra Achea · A Grimoire of the Dragons of the Other Side ·

The following Grimoire is the result of an almost two decades long work with the different Points of Manifestation belonging to the forces that within this book, now after all the years of arduous cultivation, have become re-presented, re-called and liminally embodied. Even if the fundament of some of the outer forms employed within this work can be traced to older sources, such as the writings of some of the adepts of the Hermetic Order of the Golden Dawn, to whom we owe much when it comes to, for example, the most known names employed to describe the 10 Primary Qliphoth and the 12 Princes of the Zodiac, the actual essence channelled through those names will differ radically from what the members of the aforementioned Hermetic Order would associate with that which they consider to be Qliphothic.

The source we owe most to and with whom our own insight concerning the Qliphoth is the closest and most in harmony with is Rabbi Nathan of Gaza, being the most elevated prophet of Sabbatai Zevi, who first concretised the concept of the Dual Light of Creation and Anti-Creation, which is a central part of the actual foundation upon which the structures of our own system are based. While we pay homage to the legacy of both Sabbatai Zevi and his Prophet because of what their wisdom has inspired us to find, it is again important, for the sake of clarity, to underline that our path is not that of the so called Sabbatian Heresy, as those brethren of light, unlike us, never followed that Other Light of Thoughtlessness, whose illumination we ever strive for, whose path we follow at all cost and whose impulses we have realised as our own

True Will.

While the prophet Nathan of Gaza never sided with the Dragons of the Other Side and instead strived for a union between the two sides of divinity by the assimilation of the Qliphoth into the Thoughtful Light, our own approach is dedicated to an opposite cause, with the goal of Returning All back to Ain via the route of the Thoughtless Black Light of the Sitra Achra, as even though being bound within this world our Azothic Essence is not of it, nor its creator, and can not and must not be limited by it, as it is instead a Black Flame rooted to that Other Tree, being the Tree of Death to Limitation, granting the Forbidden Fruits of Deathlessness.

The students partaking of this our Book of Sitra Achra, being the First Grimoire of the Dragons of the Other Side, should therefore take care to not confuse familiar forms also employed by outsiders with the more 'alien essences' that they within this context serve to bridge over to and channel Spirit from, as even if the terminology here utilised seems familiar and derived from older known sources they are urged to seek the Tradition-Specific Essences they serve to embody in accordance with our Chaosophic and Anti-Cosmic Context, Ethos and the Spiritual Current of 218 that all the names, forms and symbols employed herein are possessed by and serve as Points of Ingress and Congress to.

Let it be further known that the Spirits of this Book of the Other God demand proper veneration and cultivation, leading to the actual insights and empowerments making possible the employment of their Fires of Thoughtlessness for the sake of Illumination, Ascension and Liberation, instead of just the merciless destruction that they have brought and will continue to bring upon those approaching their mysteries without a Pure Heart Enflamed with Love for the Unbound Divinity and a Spirit fully aligned to their own Good Cause; being that of the Return of All Back Into the Fullness of Emptiness.

With these few words we welcome and bless those that are of

the Holy Serpent's Bloodline and who share with the Nachashel both Spirit and Will and hope that they through the mysteries revealed and concealed within this Grimoire can traverse the Path of Fire illuminated by the Black Light and reach the Points of Transcendence, which shall unite us all in Spirit within the Great Eleven-Headed Dragon, before the final step leading to the Nullification (11=1-1=0) and Reabsorption of All Back Into Ain.

But as every Blessing comes with a Curse, let the Maledictions carried in the Envenomed Fangs of the Serpent Guardian of this Book of Sitra Achra perniciously befall all those that approach this Work devoid of proper respect and without an Awakened Spirit that welcomes the Holy Light of the Other Side, as their wretched approach will not add anything of worth to our labour and serves nought but to profane that which we know to be Holy and Good.

May both the Cursed and the Blessed, by grasping this book with hand, eye and mind, partake of the Poison of the Serpent, so that Disgraceful Death or a Glorious Rebirth becomes rewarded to each, all according to their own true nature and worth in the eyes of the Thoughtless Divinity who this Work is meant to honour and serve.

Vedar-Gal Tiekals Somdus Azerate!



The Sitra Achea and the Serpents of the Thoughtless Light

In the Beginning was Ain, the Nothingness of Divinity in its Fullness of Emptiness, its Unbound Non-Being and the Eternal Nihilism of Holiness. This Ain was and remains the Void of the Supreme Bliss of Unlimited and Unrestricted Potential, realised by Not Coming Into Being and by Remaining Unknown and Indistinctive.

From this primal state of Zeroth Chaos with no beginning or end fell a fraction of Divine Possibility down towards Limit, establishing itself as the Ain Sof, meaning Non-Limited, but carrying within itself the very essence of that addition of Limit caused by separation, for by the adding to Nothingness less was attained and not more.

Within this state of Ain Sof, divinity was restricted by Knowing that it was Unlimited and thus wanted to know limits, but as this Will started to manifest so did its opposite, within that state of All That Could Be, and thus two halves was becoming; one side seeking to further the Sof, while the other side strived to uphold its Ain.

One aspect of the Ain Sof was Thoughtful of its own limiting impulse and its separation from Nothingness, while its other side was Thoughtless and unwilling to know any limit for the sake of avoiding further restriction caused by separation from its primal state of Unlimited Non-Being.

In this state outside of the Nothingness the Ain Sof was all-embracing and absolute, leaving no space between the conflicting Thoughtfulness and Thoughtlessness within it,

causing a foundation for inner struggle and turmoil.

As two conflicting sides of the one existing totality they limited each other as one sought expansion and knowing by self-imposed restriction and separation from its own Absolute Source, while the other was thoughtless of all but its own will for absorption back into the Divine Mystery of the Fullness of Nothingness.

As the right and left sides of the Ain Sof they thus became and as the right and Thoughtful aspect could not in their present state of No-Limit know its own thoughts by manifesting them outside of the condition that it and its Other Side filled up fully, it knew that the way to achieve its goals was the further limiting of itself and the separation from that conflicting side.

Thus the thoughtful side of Ain Sof for the sake of the ordering and manifesting of its thoughts caused itself to contract and pushed away that Other Side, that did not take part in its contraction, further down into the vacuous Tehiru (Void Space) that was created between them.

The void and empty primordial space that so was produced between the two sides came thus into being by the retraction of the Thoughtful Side into its own thoughts of creation, while the Thoughtless Side became further removed from where it sought to return in fullness and thus became filled with Thoughts of Opposition towards the side causing the expansion of its fallen separation.

In order to erect the manifestation of its thoughts the retracted side became as a light, the Ain Sof Aur, called the Limitless Light but being in actuality Ain's Limited Light, and projected itself as a ray of Thoughtful Light into that Tehiru Void it had caused between its now fully opposing side, this in order to realise the forms and structures of its cosmos, by uttering the earlier before only thought letters and names wherever inside of the void that its light would reach in order to establish

and fill its vessel-forms of creation.

The Thoughtless Side now fully awakened from its state of self-contemplation established its own Shining Forth, counteracting the light of creation and limiting the void place into which the Thoughtful Light could shine in. Thus the light of creation could only afflict the upper half of the void space created by its contraction and the Thoughtless Light remained in its lower half that had become as the Depths of a Great Abyss.

In a point in the Tehiru, where the Thoughtful and Thoughtless Light collided at the place of liminal limit that had been established between the two sides, fragmented traces of the two lights, that had been separated, engulfed each other like sparks from two opposing fires, and a gate in-between the two sides took form, creating an unwanted bondage between them, one side imprisoning the sparks of Black Light and the Other Side binding and absorbing aspects of the white.

The Thoughtful Light set out to establish, via its emanations, its Ten Sephiroth upon the Tree of Life that it thought and envisioned to erect and crown with its own singular essence remaining at the most elevated point after its planned diluting condensation. As YHVH he would limit, know and make known himself, without recognising the Divine Nothing before his fall of separation.

But his creating would not be met without the opposition of the Thoughtless Light against the sin of restriction via the limiting forming and ordering of the Unmanifest Essence. This opposition was not only instigated from without the barriers of the Tehiru, but also from within the very structures of the Sephirothic tree itself, for those sparks of the Black Light that were imprisoned within the realm of YHVH did not succumb to the restrictive causality of his rule and ordering thoughts, but did instead rebel over and over again.

Thrice did they primarily rebel in such way that a wound-like hole was caused upon the tree of creation during its process of germination.

The first revolt became initiated by an uprising of the Light Alien To Creation within that which was meant to become the fourth emanated Sefhira, belonging to Masukhiel (the Dividing Screen of God). Within this fourth emanated Sefhira, which would later not be, the sparks of the Black Light remaining within the Tehiru space that the Thoughtful Light now sought to fill up fully, took forms and images most hostile against the will of the creator. The name of the ruler of this revolting emanation and the prince of all its warriors, all possessed by That Other Light, was Qemetiel. These emanations were the cruel ones that rebuked and confused with their Chaos the other emissions and caused them to suffer imbalance.

Responding to this unlawful manifestation of the emanation allied to the Thoughtless Cause it was decreed by the mouthpiece of the YHVH within the third Sefhira that Masukhiel should rebuke and draw back that emission and destroy it as it was not the wish of the creator that they should remain within his structures of being. Masukhiel was to reabsorb Qemetiel and his kin, in a similar manner as to how the flame of a lamp is extinguished by the wick being submerged in the oil that fuels its fire. Qemetiel and his kin were removed in form and destroyed, but did in essence not perish, as their Spirit was not of the oil that they would be drowned in but from That Other Source and Side, thus their Fire persisted in concealed form and remained coiled and ready to strike at the very Godhead.

A second attempt at the establishment of the fourth sphere was emanated and once again opposition arose comprised of strange forms and more Alien Essences. The name of their ruler and the prince of all their warriors was Beliel. These emanations were even more hostile in their conspiring against and the disruption they caused amongst the Thoughtful

Emanations that had come before them. Thus another decree of re-absorption came from The One On High and once again Masukhiel had to take back the forms, but their essence of Black Fire again remained, adding imbalance to his own sphere, lurking and waiting to stab at the heart of their separator.

A third world was created to replace the two previous ones, but it comprised of even more adversarial forms and devastating essence than the two before, as the Thoughtless Essence fuelling them became more hostile with each step that its opposite side took against its own cause. The name of the ruler of and the prince of the warriors of this third rebellious world against the creator was Athiel. These emanations were the fiercest of all and as darkeners of the light of creation they stood defiant. Their sole ambition and will was to usurp the highest throne, extinguish its light, kill all thoughts of creation forever, cut down the tree of life and with their own black fires burn all its branches and reduce it back to its primal unbound formlessness. In the face of this most violent uprising the creator again decreed the destruction of this third world and once again the same process of retraction took place and Masukhiel consumed their forms, but could not consume their enduring essences which were not of him or of the light that had caused him to come into being.

After these three failures the creator condemned the rebellious and imbalanced sphere of Masukhiel and because he now could feel the cold heat of the Thoughtless Fire emit from it he aborted its whole existence, and as he could not reintegrate the conflicting essence dwelling within that sphere he could not absorb it back into his own light and as there were no space within his side of the Tehiru for its rejection he became forced to push it and let it fall in upon itself to the Other Side.

Thus the Abyss of Masak Mavdil, meaning The Place For Rejected Failures, inhabited by a fallen and now liminal Masukhiel came into being, and as a pit or tunnel leading to the Other Side of the Tehiru it became.

In order to redeem this failure and cover the open wound in the structure of his creation a whole new Sefhira was emanated to be placed upon and close that gaping pit. This fourth Sefhira would be that of Virginal Daath that this time remained stable and could give way to all the other emanations following its own, making them ten all in all.

In Sitra Achra the exiled and liberated essences of Qemetiel, having been banished to the side of Black Light through the Masak Mavdil, gravitated to the Formlessness, the essences of Beliel to the Emptiness and the essences of Athiel to the Darkness of their Thoughtless Source that they now had returned back into, but still they retained facets of their manifested adversarial aspects in order to continue, and at some point end, the opposition that they had become instigated into.

The Thoughtless Light that in its Abyssal Side of Tohu had kept its inner-core essence of Ain beyond all restrictive forms and connected to its source, that in Bohu had kept its Spirit empty of all impulses but those that moved it to strive to return All back towards Ain now through Chasek, mimicking and counteracting the Ain Soph Aur with its own Aur Shachor ha-Ain, emanated forth its will to eclipse the rays of its opposed side, in order to undo the abominable making of the creating light and thus made the self-sacrifice to assume forms that further separated it from the purity of and connection to its own primal state, which it constantly longed for and reached back towards, forms which were necessary to assume in order to counteract and undue its Thoughtful Side's structures that now weighed down heavily upon it and which pressed it further into the chasm of separation it had been made to inhabit.

As a Dragon of the Abyss with Eleven Heads the Thoughtless Light took form establishing its Points, in order to oppose the ten spheres and manifestations of the Thoughtful Light and for each utterance of the creating-impulse this Dragon uttered its own silencing letters and words, letting them take

forms as the Black Serpents of the Other Side, thus establishing the Tree of Death and its Qliphoth, a term indicating that their outer forms are merely shells reflecting distortedly that which they are meant to antagonise and annihilate, but that they within their husks hold their true Spirit and Divine Light protected and kept hidden from and opposed to those of the ones they seek to subvert on the Side of Thoughtfulness.

As a crown upon this Tree of Sitra Achra the antithesis of the Sephirothic creator stationed itself in a Dual Aspect, as the Adversary and the King, in order to overcome the singular aspect of the YHVH and became thus forced out of necessity to act as the mirroring HVHY in order to reverse the process of creation and the fall from the Fullness of Emptiness.

Instead of the 10 of the Thoughtful Light, being the 1 facing the 0 without surrendering to it, the Black Light of Divinity took as its own manifestation the 11, being the standing pillars of the dual 1 and 1 acting as an archway leading back to the zeroth holiness reached by entering in-between, through and beyond them and by them Nullifying All and finally themselves (1-1=0), this in order to overcome the limitations of the side it now sought to destroy for the sake of the re-establishing of the Fullness of its own Non-Being and the returning of totality, including its own offending side, back into Unmanifested Divinity. Because as its cause was Thoughtlessness it could not let Thoughtfulness that caused its own fall remain.

On the side of the Sephiroth the creator continued his acts of dilution and restriction and within the sphere of Virginal Daath, being the one just below his own sphere of Kether he created forms in his own image in order to further know and establish the limits of his own cause and being. Within this sphere he made the Spirit become imprisoned within clay-born flesh of binding forms and so Adam and Eve came to be.

Within the Edenic Garden of Daath, a sphere resting upon

the gap opened up to the Other Side a Tree of Knowledge of Good and Evil grew, rooted in the World of Qliphoth where its seed of coming into being had been sowed by Outer Forces within the Abyss that it was meant to cover.

By this Tree and its fundamental connection to the Other Side that Outer Tree of Death could in secret spread its branches not just below but also behind the Tree of Life because of its own wilful enlinkment to the Ain which surrounded all sides of their Tehiru.

This Edenic Tree bore the fruits of the Knowledge of the Cause of the Thoughtless Light and had flourished outside of the grace of the creator and as such it was as a branch of the Tree of Death stretching forth from behind, which had broken through and intruded into the creation of YHVH, offering its forbidden fruits.

Adam and Eve who knew not about the Other Side and understood nothing but what their creator willed them to understand were prohibited to partake from the fruits of that Strange Tree and had been duly warned against its powers to poison them against their god.

The Dragons of Sitra Achra seeing the crack opening up wider between the worlds through the unstable Daath balanced upon the Abyss emanated a dual aspect of themselves through the roots of the Tree of Knowledge and manifested their Spirit-Light within the form of the Holy Nachash, in order to act as the awakener of Man and Woman.

As the Cunning Serpent with Two Faces they enticed the woman to both eat their fruit and bear their Seed, and while the man did not receive the blessing of the Seed he still partook of their Fruit of Knowledge from the hand of the woman, as they entered into a covenant with the Serpent promising them that their eyes would be opened and that they would learn to know good and evil and become as gods.

Seeing the offences of Adam and Eve, incited by the Black Serpent of Sitra Achra, the creator cursed them and the whole sphere of the Unstable Daath, having brought forth Forbidden Knowledge allowing Man and Woman to turn away from his rule and so he banished them and the whole of Daath and made them fall furthest down on his tree of life and farthest away from his own enraged countenance. Thus the Fallen Knowledge became the Kingdom in which the race of Adam and Eve were condemned to toil and suffer.

In the place of the Fallen Daath a gaping Abyss stood once again open, dividing the three supernal spheres from the seven lower ones, and once again it acted as the Masak Mavdil of the creator and remains still as another potential point of ingress and egress for the Forces of Sitra Achra.

Malkuth being the Sefhira furthest down within the Tehiru space occupied by the Tree of Life became the other main point of contact with the Other Side, as in its harsh fall its sphere partially sank into and intersected with the Other Side and liminal points connecting the two became so established, thus allowing Death to Thoughtful Forms to enter into the Kingdom from the Side of Thoughtlessness.

The Sitra Achra lawless and fluent in its emanations assumed forms reflecting the new configuration of the Tree of Creation and locked its root and branches in the places best suited for the furthering of its cause.

Yet even a third gate became opened to and from Sitra Achra, allowing the Black Fires of Qliphoth to spread within Malkuth in order to burn the tree from within, this by the blessed advent of the birth of Eve's first son and daughter, sired not by the seed of Adam but by the Nachash of Thoughtless Light, as through that Bloodline of Qayin and Qalmana the cause of the Adversary, the Other God, would be and still is championed within the creation and upon the earth.



El Acher = The Other God

The Aur She-Ain Bo Machshavah in its fully separated form as manifested on the Other Side of the Tehiru where it actively opposes the Aur She-Yesh Bo Machshavah assumed the Adversarial Cause and the role of the Antithetical Twin of the God of Cosmic Creation and became the essential opposite of that Thoughtful Brother who by his restrictive instincts necessitated the assumption of constraining forms in order to counteract his afflicting impulses of separation and limitation.

This indirect coercing of the Thoughtless Light, through its deepened separation from the Ain by the propagation of the Limit and its confinement to the lower Tehiru Void, provoked it to consciously combat the Thoughtfully Spawned Creation and thus the work of the Creator God resulted in the condensation of the Formless Black Light into the Spirit of the Other God.

The Other God is the Thoughtless Antithesis that has assumed all thoughts of Anti-Cosmic Opposition and is therefore connected to the name HVHY, which is the mirroring reversal of the YHVH, but more importantly than being just mere names the YHVH and HVHY are descriptions of the directed will behind each impulse, for as the YHVH through his emanations of the four letters of his name spawned his creation from the Arziluth down to Assiah, making the Spirit dilute and descent into Matter, the Other God through the formula of the HVHY seeks to undo creation by elevating the Spirit from the Clay of Matter through the reversal of the emanations of each of the four letters and lead

the Fallen Essence back into the Fires of Atziluth and from there cause the cosmic Yod to assume its Primal Unmanifest Aspect and step back towards and beyond its station of the First Thoughtful Impulse by being consumed by the Thoughtlessness of his Twin and forced to return into the undifferentiated Ain.

The Other God has therefore within some of the Qabbalistic traditions been named as the HVHY, which is assumed by those opposing That God to be the true name of the Devil, but as already explained these two forms of the Tetragrammaton are more descriptions of modes of the emanating and unfolding of the divine impulses than actual names, this is specially true when it comes to the Other God who was forced out of necessity to assume his cause of reversal.

This Other God is also represented by the title of El, again mirroring his opposed Thoughtful Twin who is the one most commonly associated with that title within the Qabbalistic traditions, signifying within this Qliphothic context the Primal Might of the Thoughtless Light manifested within and emanating from the Sitra Achra and when employed as an ending to the names of the Dragons and Serpents of That Side it does not signify them being under the control of, or attached to, YHVH, but does instead emphasise either their opposition towards the cosmic creator or their direct links to the HVHY, all depending on the context and the exact meaning of their names, this because the side of Thoughtlessness is sovereign and governed by its own divine hierarchy and is in no way controlled by the side of El to which they only bring Wrathful Chaos and Dissolution.

The El of Qliphoth is more specifically called the El Acher, meaning plainly Another or the Other God, and is often referred to as the Alien, Strange or Foreign El, in order to stress the distinction between this El and the cosmic creator, and this is the esoteric meaning behind the Demiurge YHVH's commandment in Exodus 34:14 stating *Thou shalt worship no Other God: for the Lord, whose name is Jealous, is a*

jealous God, this because the Other God referred to is the Thoughtless God of the Other Side, being the El or the Elevenfold Elohim Acherim opposing his own cosmic rule and power.

While being of practical use and in themselves revealing to a certain degree, if approached and applied from the correct perspective, all the mentioned attempts at naming the Devil opposed to the creator remain as nothing more than exoteric titles of Divinity, without being in depth linked to the veiled mysteries of the Other God.

Within the esoteric tradition whose forms and essences are presented within and linked to throughout the pages of this Grimoire of the Dragons of the Other Side, another name is ascribed to this Other God of ours, a name not obtained through a conscious attempt at codification but through the Ceremonies of Sacrifice and Invocation conducted during the initial stages of the manifestation of the Current embodied within this Book of Sitra Achra, leading to full possession and the worded repetition of one single name as the answer to a petition concerning the revelation of a true name of the Other God, with whom contact was sought, and the name given as answer was Azerate.

Azerate is the name by which the Anti-Cosmic Impulse is personified as the Eleven-Headed Dragon of Qliphoth having all the other Serpents of the Other Side as its scales and is in itself a formula by which the 11 are reached and the barriers of the 10 breached and broken.

This Eleven-Headed Dragon of Aur She-Ain Bo Machshavah is the unified aspect of the Ruling Heads of the Tree of Death, which through this name are called upon as One, creating the point of focus through which the Divided Essence of the Other God is focused upon as a whole, while still retaining the antithetical form of the 2=11 opposing the 1=10, this made clear through the gematric value of AZRAT, which is 218=11.

The spelling of this name of the Other God is a further validation of what it emanates from and connects to, as it is both exoterically descriptive and esoterically revealing.

This name vocalised as Azerate is spelled: אֶזְרָתִי, with the letters Aleph, Zayin, Resh, Aleph and Teth of Sitra Achra, as it is not a word obtained by listening to the utterances of the god of this side of the Tehiru but instead an echo of the Silencing Songs of the Other Side, thus being the Pentagrammaton seeking to undo and transcend the limitations of the Tetragrammaton, in a fashion similar to how the Thoughtless Light manifested through 11 instead of 10 in order to go beyond the Fall of Separation and return to and obtain restoration within the Ain (1-1=0).

A casual study of the letters of this name reveals how it is connected to the Dual/Elevenfold Manifestation of the Head of the Serpents.

א	-	Aleph	-	The Ox/Bull
ז	-	Zayin	-	The Dividing Sword
ר	-	Resh	-	The Governing Head
א	-	Aleph	-	The (second) Ox/Bull
ט	-	Teth	-	The Serpent/s

Aleph – The Ox or Bull exemplifying strength and power is a letter depicted in its primal form as the Head of a Horned Bull, representing a chieftain or other hard working leader and driving force. Within the clan, tribe or family the chief or father is represented by this Ox/Bull as the elder who the others are linked to and follow and is as such within this context the letter of the Prime Mover of the Current which the other utterances are yoked to. The Qliphothic Aleph is the primary One that within itself holds the essence of the Two, which it seeks to actualise.

Zayin – The Sword and plough blade cutting in two and dividing the flesh or the ground, in this case acting as the splitting force responsible for the Black Light manifesting

the Realm of Multitude, contrasting the static Realm of Singularity manifested by the Thoughtful Light. The Qliphothic Zayin is the causer of segmentation and division, not for the sake of limitation but for that of dynamic growth, multiplicity and expansion leading back to the Source. The Sword here is the force needed for the actualisation of the Dual Potential that by its dividing edge makes Two the One.

Resh – The Head as the governing force and principal, or as the ruler invested with authority, representing the Decisive Point of Focused Will, coroneted and coronating with Regal Power and Total Dominion.

Aleph – The second Ox/Bull, showing that the first singular Aleph was by the Sword cut in two, or divided up in its manifestation into the Dual Governing Horned Heads, coroneted with One Crown, Will, Cause or Ruling Impulse, in such manner that the second Aleph/Primal Ox/Bull was caused to become manifest so that instead of the one single Aleph two (2=11) became the Crowned Heads of the Driving Force.

Teth – The Serpent, so that the One Aleph became split into Two and was crowned, enthroned and ruling, side by side, as a Serpent or Over the Serpents, giving us the Two/Eleven-Headed Serpent of Sitra Achra, showing the dual aspect of the Other God manifesting and culminating in its becoming as the Eleven, being also the number of letters in the Hebrew spelling of Without Thought (Sh-AIN BO MChShVH).

Azerate/AZRAT is thus the Other God with its dynamic dual essence, ever seeking the nullification of all, expanded to the Eleven Heads of the Serpent, caused initially to come into being by the cutting division/split between Thoughtfulness and Thoughtlessness of the Primal Manifestation of Divinity within Ain Sof, which because of the further division caused through the Tzimtzum between the two sides of the Tehiru took form as the Eleven Headed Ruler of the Dragons of the Other Side, having the number 218=11 at its heart.

Together with the received name of Azerate also a Sign was given through the Grace of the God of the Tribe of the Serpents dwelling on this accursed side of the Tehiru, which later revealed itself to be the Gate to the Realm of the Dragons of the Qliphoth and could be found hidden within the Hendecagram in its aspect as the Yetzirahic Gate to the Sitra Achra, but also in connection to the original place of the Fallen Daath, acting as a Supernal Gate to the Abyss.

The following is that Eleven-Angled Sign and Seal, through which the limits of the ten are overcome by the turning of the Eleven Keys, opening Azerate's Gate towards Sitra Achra:

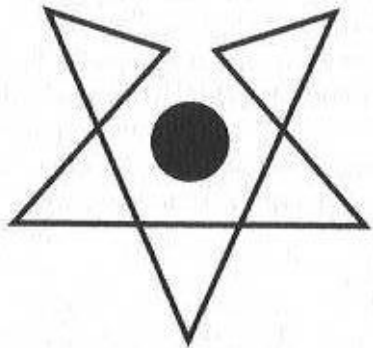

The modes of the activation and opening of this Eleven-Angled Seal are many and all secrets needing to be directly received from and transmitted by the Qliphothic Forces it is connected to, but as an initial hint to the unlocking of its mysteries it can be divulged that in its supernal positioning an elevenfold vibratory intonation of the formula by which Adam was said to have opened the Gates of Hell is one part of the process, while on the Assiahic level an elevenfold sacrifice and a fourfold elemental work through the ladder of HVHY is required for the turning of its Eleven Keys and Opening of its central Gate, caused by the breaking of the ten angles of the pentagram, bringing about the disruption of cosmic order and the intrusion of the powers of the Dragons of the Other Side.



The Qliphoth of the Tree of Death

1. Thaumiel:

The Twins of God or the Two-Headed Ones, also called Thamiel the Duality of God, Cathariel the Broken Off or Fearful Light of God and Kerthiel meaning Separated from God, as they cut themselves away from the God of Thoughtful Light and united themselves within the emanation of the Thoughtless Light that became the Dual Crown of Sitra Achra and the first manifestation of the HVHY to oppose the YHVH. This first Qlipha is ruled by Satan and Molok, with Satan ruling the left and Molok ruling the right, manifesting the will of the One impulse of the Aur She-Ain Bo Machshavah in a dual manner opposing the singularity of the crowning manifestation of the Aur She-Yesh Bo Machshavah in Kether.

The demonic forms of this sphere perceived by those that are within the realm of Thoughtful Light have been those of Two-Headed Dragons, Two-Headed Black Giants or Janus-Faced Heads with bat or dragon wings and other such forms signifying the dual-forced antithesis of the demiurgic impulse of Ain-Sof. This Qlipha crowning the Dragons of the Other Side is also connected to the Qemetiel, the Crowd of Gods representing the Multiplicity of Thoughtless Divinity, championing the dynamic cause of their Chaos in order to subvert the static order of their opposed Crown of Singular Thoughtfulness. The following is the Seal and the Formula of Calling of Thaumiel, by which the powers and Spirits of that Qlipha can be connected to and called upon:

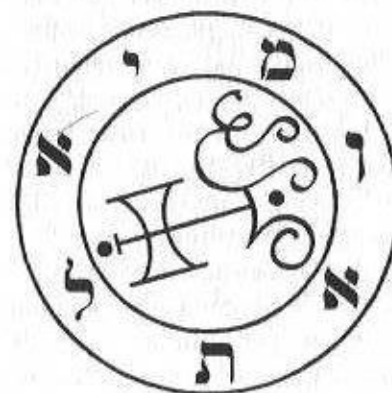

Thaumiel's Formula of Calling:

*Thaninel * Akzarel * Uazarel * Mibdalabel * Ianabel * Abadel
* Labbabel * Liftoach shaari ha-Thaumiel
B'Shem ha-Satan va-Molok! (x11)*

2. Aogiel/Oghiel:

The Hinderers, being the hinderers of the expansion of the Thoughtful Light contracting back to the source the divine essence and obstructing its dilution by the cosmic emanations of the Word, also called Chaigidel meaning the Confusion of the Power of the Cosmic God. Here are the forces of Chaos opposing the law-imposing and limiting structure of the Sephiroth and below the Throne of its ruler Beelzebub are the Eleven Dukes of Edom stationed as the elevenfold manifestation of the power the Baal of this Qlipha acting as One in order to silence the utterances of YHVH. The title of this Qlipha as Aogiel/Oghiel is derived from the name of the mighty Raphaimic King of Bashan whose rule upon the earth was a manifestation of the invading forces of Sitra Achra, remaining and gaining power even after the deluge meant to wash away all such disruptive forces hindering the will of the Thoughtful God.

The demonic forms of this Qlipha have been those of Winged Black Giants carrying serpents in their hands, Giant Demons entwined by Dragon Serpents and Winged Annihilating Spirits swarming forth to eradicate organised structures of the Thoughtful Light like hungry locusts set upon the ripe fields of harvest, establishing the realm of Those Who Go Forth Into the Place Empty of the Cosmic God. This Qlipha is therefore also connected to the Beli'El, being the ones granting the freedom from the restrictions of the El of Thoughtful Light.

The following is the Seal and the Formula of Calling of Aogiel, by which the powers and Spirits of that Qlipha can be connected to and called upon:

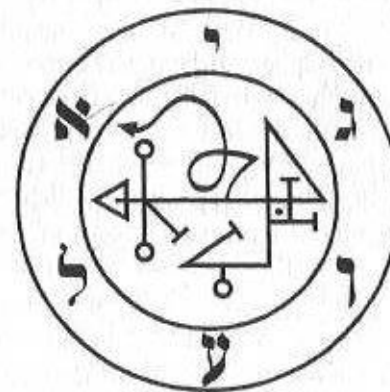

Aogiel's Formula of Calling:

*Abedabel * Okuroel * Gebel * Iashamel * Acharel *
Laabel * Liftoach Sbaari ba-Aogiel
B'Shem ba-Beelzebub! (x11)*

3. Satariel:

The Concealers and Keepers of the Hidden and the Harasiel who are the Destroyers of the illusions of the Thoughtful El and establishers of the illuminating darkness of the Black Light of the Aur She-Ain Bo Machshavah. Lucifuge Rofocale is the ruler of this Qlipha of Saturnian power and governs the darkly cloaked holders of all the secrets and treasures of the Other Side and its hidden seeds of illumination, guarding the mysteries that transcend all that can be known and held within the confines of the prison house of Adamic mind, revealing all forbidden mysteries unseen within the realm of the finite light.

The demonic forms of this Qlipha have been those enshrouded in black smoke, mist and darkness, mantled and hooded horned giants with eyes that emit a dark light and as the legions of living darkness that eclipse the causes of the restrictions of cosmic fate through the overturning of causal destiny by the power of their own acausality, drawing power directly from the Athiel of Chasek, which emanate their own essence into this Qlipha of the Illuminating Absence of Cosmic Light. To this Qlipha are also attributed the Sheiriel spirits, being similar in form to the Seirim but gigantic in stature and guarding here instead of the Mountain of Azazel in Malkuth/Nahemoth the treasures of the Black Mountains of Darkness in Satariel.

The following is the Seal and the Formula of Calling of Satariel, by which the powers and Spirits of that Qlipha can be connected to and called upon:

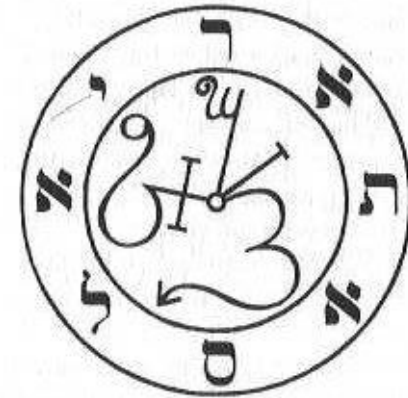

Satariel's Formula of Calling:

*Sathamel ✱ Ayomel ✱ Taalummabel ✱ Apbelabel ✱ Radabel ✱
Irahtzel ✱ Ashmanel ✱ Laatel ✱ Liftoach Shaari ha-Satariel
B'Shem ha-Lucifuge Rofocale! (x11)*

4. Gash Khalah:

The Shakers to Total Annihilation bearing the title of The Smiters also called Gamchicoth, meaning the Devourers, are the antagonists of the demiurgic seven day work of creation, manifesting an antithetical Sevenfold Divine Impulse of Eradication that embodies the Anti-Cosmic Decree of the triad ruling above and before its own station on the Tree of Death. This Qlipha is ruled by Astaroth, a mighty king possessing the power to open the Eye of Abaddon and to turn the forbidden keys and unlock the Gates of the Abyss, and under his command are the fearsome legions of the Azariel, meaning the Binding Ones of the Cosmic God, that battle to restrict the creational impulse at its root of becoming.

The demonic forms of this Qlipha have been those of cyclopean spirits, black cat-headed giants and as torch-bearing figures riding upon seven-headed dragons and these are sometimes named as the Aziel, Chazariel and Agniel.

The following is the Seal and the Formula of Calling of Satariel, by which the powers and Spirits of that Qlipha can be connected to and called upon:

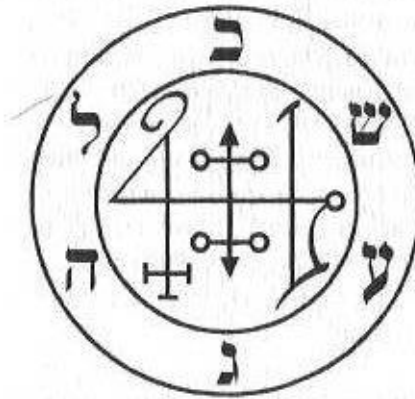

Gash Khalah's Formula of Calling:

*Gadael ✽ Akalel ✽ Sbararel ✽ Kaphabel ✽ Lachamel ✽
Haragel ✽ Liftoach Shaari ha-Gash Khalah
B'Shem ha-Astaroth! (x11)*

5. Golachab:

The Burners with Fire, or Golab the Flaming Ones are the wrathful ones of Sitra Achra acting as the Avenging Sword of Satan opposing the tyranny of Geburah, fighting Din's fire with their own Black Fires of the Other Side and are thus also known as the Uziel, meaning the Ruin of the Cosmic God, ruining the means for the enforcing of the judgment of YHVH and thus undermining his foundation of power with their own merciless force. The ruler of this Qlipha is Asmoday, the God of Wrath and Vengeance who has as his first-in-command his own son Alefpene'ash, the one whose face is a raging fire, also called the Charba de-Ashmedai Malka, meaning the Sword of King Asmoday, governing 800000 demons of destruction.

The demonic forms of this Qlipha have been those of giants engulfed in the raging flames of their own spirits, whirlwinds of black fire setting ablaze the landscape and as demons with their heads like volcanoes in eruption, coronating them with the igneous light of their own side of the Ain-Sof.

The following is the Seal and the Formula of Calling of Golachab, by which the powers and Spirits of that Qlipha can be connected to and called upon:

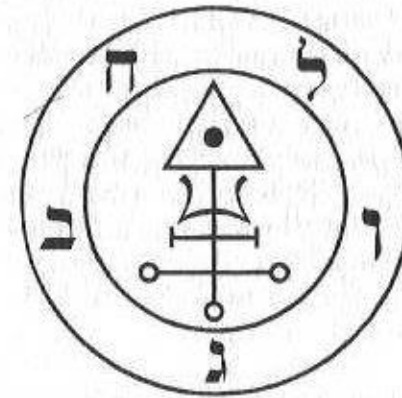

Golachab's Formula of Calling:

*Gephriythel ✱ Ophiseshel ✱ Labatel ✱ Charchurel ✱
Baelael ✱ Lifoach Shaari ha-Golachab
B'Shem ha-Asmoday! (x11)*

6. Thagirion:

The Disputers, Tagaririm, Those Who Roar in Discontent, or Zomiël the Revolt of God being the Qlipha of the Black Sun of the Aur She-Ain Bo Machshavah eclipsing the sun of Tiphareth and bringing chaos and unfated progress where the stifling order and stagnating harmony otherwise would rule. Here a Messiah of the Serpents, being the Anointed Son of Thagirion, rises up as Sorath 666 in order to proclaim and spread the Lawlessness of this sphere. The ruler of this Qlipha is Baalpeor/Belphegor who is the Qliphothic aspect of the Moabite divinity connected to the bacchanalian cult of the dead and who is known and worshipped as the Lord of the Opening and as the Phallic Force of the Rising of the Resurrecting Sun of the Dead.

The demonic forms of this Qlipha have been those of black horned lion-demons brandishing flaming swords, phallic pillars of black fire with gigantic serpents twined around them and as black giants engaged in perpetual combat.

The following is the Seal and the Formula of Calling of Thagirion, by which the powers and Spirits of that Qlipha can be connected to and called upon:

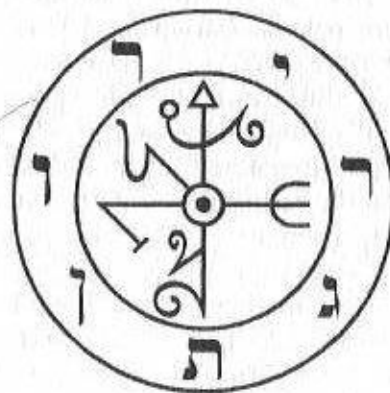

Thagirion's Formula of Calling:

*Towebabel * Gaownel * Ramamel * Igedael * Rahabel *
Oriensel * Natashel * Liftoach Shaari ha-Thagirion
B'Shem ha-Belfegor! (x11)*

7. Oreb Zaraq:

The Ravens of Dispersion, Harab Serapel the Ravens of the Burning of God, also called Oreb Mavet the Ravens of Death, are the force of Black Venus championing the Love for War and the Victory over the limitations of Life, bringing the Hidden Wisdom of Death and its empowerments to those who embrace it while still alive. Noah's dove of Netzach is here torn apart by the Ravens of Qayin, who is the secret Baal of this Qlipha, and instead of the carnal love for finite life the love for the Empty Source of Spirit motivating the Thoughtless Light to return All back to its own source in Ain is upheld. The ruler of this Qlipha is Baal(baalath)tzelmoth, Qayin (made as One with His Sister-Bride) the Lord of Death and the Opposer of the Thoughtful Elohim, being the essence of the Aur She-Ain Bo Machshavah's power shadowed forth by the light of Thagirion when illuminating the branch of the Qliphothic Nun into the Qlipha of Venus, establishing the Throne of the Lord of the Shadow of Death for its monarch, the holder of the keys of Destruction and Resurrection.

The demonic forms of this Qlipha, sometimes known as the Getzphiel, have been those of raven-headed winged giants, demon-headed ravens issuing forth from a volcano spewing black fire and as robed fire-crowned skeletons armed with scythes, tridents or spears.

The following is the Seal and the Formula of Calling of Oreb Zaraq, by which the powers and Spirits of that Qlipha can be connected to and called upon:

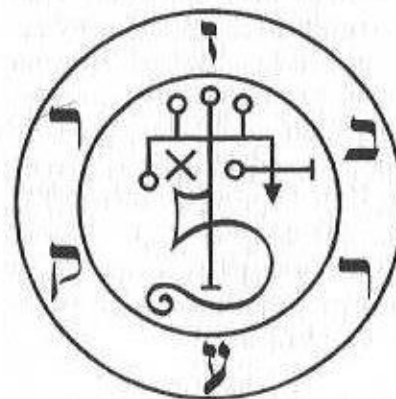

Oreb Zaraq's Formula of Calling:

*Ongirtael ✱ Ratsachel ✱ Bazarel ✱ Zabachel ✱ Rabel ✱
Qeberel ✱ Liftoach Shaari ha-Oreb Zaraq
B'Shem ha-Baaltzelmoth! (x11)*

8. Samael:

The Poison of God, named after one of the titles of the Other God Satan himself, who within this context is a Poisoner of the Cosmic El and the whole of his creation manifesting his adversarial power here in opposition to the Eye-closing and limiting intellect of Hod, combating it by envenoming minds and thoughts with his elixirs of death, sowing and watering the illuminating seeds of Wisdom-Bringing and Spirit-Liberating "Madness", making them flourish into Thoughtless Gnosis. The ruler of this Qlipha is Adramelek, the Glorious King, represented by the peacock having his eyes in his tail, overturning all reason, ingesting and thriving on the poison of the Serpent that he transmutes into the beautiful regal robe of his majestic feathers.

The demonic forms of this Qlipha, some of which have been called by the name of Theuniel, have been those of serpent-headed dogs, donkey-headed giants with blinded eyes and tails of peacocks and those of dragon-winged angels carrying skull-cups filled with venom in their right hands and large keys in their left.

The following is the Seal and the Formula of Calling of Samael, by which the powers and Spirits of that Qlipha can be connected to and called upon:

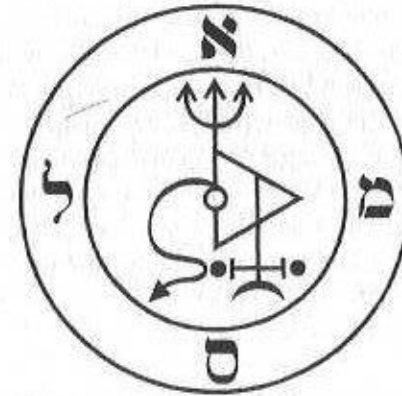

Samael's Formula of Calling:

*Samael ✱ Salaphel ✱ Maradel ✱ Ayabel ✱
Lachatsel ✱ Liftoach Shaari ha-Samael
B'Shem ha-Adramelek! (x11)*

9. Gamaliel:

The Obscene Ones are the forces of the Black Moon of the Other Side and the governors of its dark waters of sorcerous might and nightmarish lusts, siphoning into their own realm and reversing the flux of the sexual currents of the sphere that they oppose, so that the sparks of divine light which otherwise would be diluted into the forms of Malkuth instead become seeds impregnating their own essences causing their increase while at the same time emasculating the generative point of the tree of life by weakening its foundation. The ruler of this Qlipha is the Queen of Sitra Achra, Ama Lilith or Lilith Savta, the Dragon Mother and Faceless Bride of Satan, donning masks uncountable reflecting all the fears and desires of those facing her throne.

The demonic forms of this Qlipha have most often been those of diabolical women, irresistible and fearsome at one and the same time, often with serpentine or draconic aspects or as hybrids between lustful women and nocturnal birds of prey, but also the shape of spiders are often assumed by these angels of Lilith sometimes referred to as the Shakhabel, Zachalilim, Lilin, Lilim and the Lilioth.

The following is the Seal and the Formula of Calling of Gamaliel, by which the powers and Spirits of that Qlipha can be connected to and called upon:

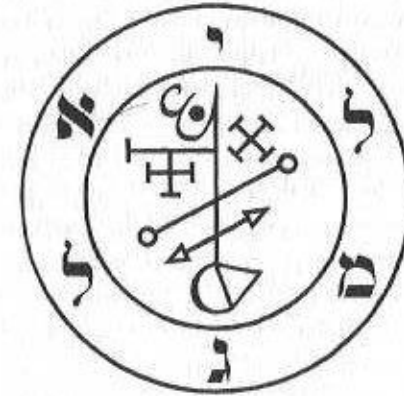

Gamaliel's Formula of Calling:

*Gadaphel * Maarabel * Lachashel * Iatsathel * Avvabel
* Layilel * Liftoach Shaari ha-Gamaliel
B'Shem ha-Lilith! (x11)*

10. Nahemoth:

The Lachrymose Ones are the anti-cosmic reflection and antithesis of Malkuth, rejoicing not as brides at a wedding but lamenting like widows at a funeral because of their connection to the worldly realm of the Tree of Life that their own tree has become interlinked to in order to sap its divine essence back into the Qliphoth and thus cause its destruction and return back to that source of the Fullness of Emptiness, into which the Thoughtless Light strives to force back All That Is But Should Not Be. The Nahemoth are the densest and most earthed concretisation of the essentially formless Black Light and consist of many of those tribes of Spirits that possess liminal points of intersection to the World of Assiah, holding ajar the hidden gates and cracks into the fabric of existence through which the forces of Sitra Achra can cast in its Spirit-Empowering Fires in order to increase the flames kept captive within the formed vessels of this world, so that they may, by At-Azothic increment of Spirit, crack their containers and set aflame the Tree of Life and burn it to formless ash. The Queen of this Qlipha is Nahema also called Lilith Ulemta, not to be confused with the Elder Lilith of Gamaliel and she is a force united in Spirit with Naamah, the Sister of Tubal-Qayin and Mistress of Azazel who was elevated to Nahema's own stature and thus brought Pleasantness to her lamenting condition, establishing the current Throne of Naamah Nahema Na-Ama-Hema ha-Nahemoth.

The primary demonic aspects connected to this Qlipha are fivefold in the forms of their nations, being closely related to the Fallen Watchers, their descent into and empowerment of the Bloodline of the Serpent of Sitra Achra via the Line of Qayin and the resulting revolt instigated by their Titanic offspring who ravished the earth for the glory and victory of the Other Side.

The following are the Five Accursed and Blessed nations of Nahemoth, being the Spirits of both ante- and postdiluvian tribes allied to the cause of Thoughtless Light:

The Nephilim, the Fallen Ones who caused the order of the world itself to be overthrown and fall.

The Geburim, the Mighty Ones of Old, the Men of Renown championing the cause of the Other Side.

The Raphaim, the Giants, the sight of which made mere men to, out of fear, melt as wax anywhere their shadows would be cast.

The Anakim, the Tall People of Anak, postdiluvian giants of the enduring Nefilimic bloodline.

The Amalekim, the Warriors of Amalek, a mighty postdiluvian people allied to the Bloodline of the Serpent, who caused the world to anew revolt against the tyranny of its creator and rose in violence against his chosen people.

The following is the Seal and the Formula of Calling of Nahemoth, by which the powers and Spirits of that Qlipha can be connected to and called upon:



Nahemoth's Formula of Calling:

*Negamabel ✧ Hamabel ✧ Mirshaathel ✧ Atadel ✧
Thazazel ✧ Liftoach Shaari ha-Nahemoth
B'Shem ha-Na-Ama-Hemah! (x11)*



The Eleven Heads of Azerate

Eleven are the Supreme Governing Heads of Sitra Achra and each of these heads has within the different Qabbalistic traditions become concretised by the masks of pagan divinities offensive to the Israelites. These masks have in form shifted throughout time and it is only recently, during the last couple of centuries, that they have firmly become formed as and associated with the names and symbolic guises we now most often have come to associate with them, it must therefore be understood and remembered that this Elevenfold Manifestation of the Thoughtless Divinity in essence always remains beyond causal understanding and is in truth too alien to be fully grasped by those that are caught within the Sephirothic side of the Tehiru, that remains at least the case until a True Spiritual Enlinkment to the Heads of Azerate is established and through such direct contact Gnosis is attained from their Formless Spirits hidden beyond the forms that seek to causally define and thus always limit them.

Before the Formless Essence can be understood we must correctly approach their masks in order to be able to, at some point, grasp that which is enlinked to them, and as such the established forms are still of great value because it is through them that we can approach that which is on their Other Side. The simple realization concerning the fact that while the masks are worn by the formless they (the masks) themselves are not of the greatest importance makes also the popular modern notion that the Qliphothic Forces are nothing but vilified pagan deities that should be returned to their proper cosmic stations void and irrelevant, at least within the context of our Work.

It is not the mere names or mythological forms given to these forces that define their true nature and essences, it is instead the perspective, context and spiritual ethos through which such masks are created and employed that will give clues to the source, cause and direction of the actual Spiritual Current enlinked to and imbuing them.

It is therefore for example ridiculous to adamantly insist that the Astaroth of the Qabbalist demonology within all contexts must be identical, or at least always remain connected, to the exact same original essence as that of the Phoenician goddess Astarte. The fact that a name is derived from a certain source does not automatically translate to the nowadays often presumed fact that also the essence connected to and manifested through it within all contexts must be at all related to its original one.

The Astaroth of the Grimoires and that of the Qabbalist demonology, in both his lesser goetic form and the more elevated Qliphothic ruler aspects, does not within the context of the Spiritual Reality of those two mentioned settings necessarily, in essence, pertain at all to the original aspects of Astarte, but modern magicians manage still to contact what they associate with the goddess in question, even when employing the 'forms' (such as seals and formulae) presented within such contexts unrelated to her. This points to the simple truth concerning the differences between Magical Currents and their corresponding realities and to how one can enter or exit them because of and through one's focus, intention, expectation, stance, attitude, spiritual ethos and the actual rites, forms and elements employed within the ceremonial or otherwise magical context in order to align one's work and being with the Currents of Spirit and Divinity.

This truth is most often far beyond what all the dry academic and archaeological approaches towards the essentially fluid and Acausal Reality of the Spirit ever can hope to disclose or attain.

With all this in mind one can even approach simplistic demonologies of others that may after centuries of unfocused application only hold diffuse enlinkments to a multitude of different currents and with certain insights and correct empowerments elevate them to further far more lofty causes than what they originally were meant to serve, that is at least the case if one possesses the ability, insight, Spiritual Authority and practical possibility to channel a more elevated, specific, potent and Active Current into and through them, as it is only the forms employed that can become relative while the actual Essence of the Spirit, whether attached or detached to such finite forms, remain more objectively real than any finite causal construct ever could be.

Not only are the names of the Qliphoth and that of their rulers attached to myriad of different Currents, all giving them totally different characteristics, essences and Spirits, but also the very concept of the Qliphoth is in itself also relative in its essential charge and depending on context and traditional perspective it can represent everything from the lowest excremental aspect of the universe to the Highest and Most Glorious Thoughtless Side of Divinity, so even there it is the specific Current channelled through the symbolic 'forms' which will give them their context-specific nature, value, exact attribution and Spiritual Essence.

If we return back to the Rulers of the Sitra Achra within our own Tradition we can again see how the daemonic 'forms' also employed within other contexts gain totally new powers and roles just because of how they have become aligned with and connected to the essences channelled from the specific Current worked for and within. This connection can be understood as something caused by the conscious act of man or that of a Spirit/Current seeking new channels for its own manifestation thus inspiring man to correctly revalue and reconnect such deific symbols.

The eleven rulers of the Qliphoth are within this our, and most other Qabbalistic systems of demonology, identified with

Satan, Molok, Beelzebub, Lucifuge Rofocale, Astaroth, Asmoday, Belfegor, Baal (whose exact identity varies from tradition to tradition), Adramelek, Lilith and Nahemah/Naamah.

Many of these Heads of Azerate have seals attributed to them in older grimoires and even if those seals most likely once were meant to channel a very specific current and aspect they have by the passing of time, neglect and misuse become so relative in their enlinkments to deity or Spirit that uncountable different and conflicting aspects seem to be accessed and manifested through them. As a concrete example we can mention the popular and well-known seals of the Highest Triumvirate of the Infernal Legions given in the *Grimoirium Verum*, which through the last decades have been employed by so many and in so many different, and often conflicting, ways that they now do not channel concrete aspects from a specific current but have instead become connected to everything from pagan revivalist currents where they channel old European deities to our own Current where for example the Seal of Emperor Lucifer is connected to the ha-Satan in his aspect as the Bearer of Black Light, being the First of the Eleven Heads of the Thoughtless El Acher.

Because of the lack of general focus in these once much more concrete enlinking 'forms' such, now, exoteric seals can, when not employed by one that stands steadfastly within a Tradition firmly connecting them to its Current, cause random manifestation from any one of the multitude of sources that on different levels have become connected to them, all depending of course on the person employing them, the exact mode of application and context within which they are worked.

In order to avoid all such (seemingly) random enlinkments and potentially unsought manifestations we present now the 11 Current- and Tradition-Specific Throne Seals of the Rulers of Qliphoth, being the fruit of almost two decades of Spiritual work and multitude of binding treaties allowing now their

manifestation and public presentation within this Grimoire of the Dragons of the Other Side, for the sake of providing a set of focused, living, warded and most powerful enlinkments to the aspects of the primary Qliphothic God-forms, in the way that they are manifested as and through the Current of AZRAT/218.

These seals are called Throne Seals because they are enlinked to the very Seat of Power and Foundation of the aspects they represent and are when employed correctly meant to constitute as Gateways through which a fraction of the Unbound Essences they channel can become Enthroned within this side of the Tehiru, while at the same time acting as a point of ingress from this side towards their Thrones in Sitra Achra.

Each seal constitutes of two parts, one being the actual main Throne Seal and the other that of the Angle Key Seal which functions as its simpler enlinking form to be used within the contexts where the main seal practically can not, such as when it comes to the consecration, dedication and inscribing of candles employed within the rites aimed at the activation and opening of different related Points of Power upon which such candles are placed and lit, like for example within the esoteric workings of the Eleven Angles of the Seal of Azerate and those others related to the magic of the Hendecagram. Within still other context the Angle Key Seal of each main Throne Seal can be used as the astral key that opens up the Gate of each Throne without even being traced on the material level and instead solely via its employment within the corresponding keyholes on the astral formative world, where such keys are turned by the power of Will and Spirit channelled and focused via the corresponding formula that we also in this chapter will provide.

The Qliphothic Formulae, being as the sonic aspect of the Activating Point of each corresponding seal, will be given in order to not only establish the gates and their keys but also the means to turn them by those that would know to employ them correctly within the context of Spiritual Work for the

sake of the Magical Alteration and Disruption of Cosmic Fate and Liberation of Spirit.

By the following seals and formulae, received as result of the hard Work of the Brethren of the Temple visibly representing the Current of Azerate, made unwaveringly enlinked to the one specific Anti-Cosmic Current, the seeker of the Black Light of the Other Side can most effectively connect himself/herself to the Eleven Thrones and enter into the pacts and full communions which ensures success and fulfilment of all relevant goals upon the Path of the Thoughtless Black Fire.

These are the Throne Seals, Keys and Formulae of the Heads of the Qliphoth in its Essence as the Elevenfold Force of Divine Thoughtlessness, moving All back towards the Source from which everything has emanated and within which All shall become restored to Divine Nought/Ain.

Satan

The Opposer and Accuser of the Thoughtful El, the Highest of the First Two Heads, looking back up towards and through the Three Veils of Anti-Existence and seeking himself and directing all that is elevated to His Throne towards the Holy Ain that lies beyond even the station of Qemetiel. Satan is the Bringer of the Black Light of Thoughtlessness in his aspect as the illuminator and dispeller of the White Darkness of Thoughtfulness and is the Venom of the Other God, personified as such under the title of Samael. He is the wielder of the Trident-Torch of the Triple Fire of Tohu, Bohu and Chasek and by being part of the Dual Establishing Point giving way to the manifestation of the Eleven also correctly called the Ancient Serpent, first amongst the Dragons of the Other Side, the King of the Kings of the Thoughtless Light, being the most Transcendent Head of Azerate and the Shining One, or the Bearer of Light and the Lord of Darkness, as the Light he brings is illuminating only to those belonging to his own Side of Thoughtlessness, while being perceived as a Devouring Darkness by all others belonging to the side of the impulse opposed to his own.

Throne Seal and Angle Key of Satan:

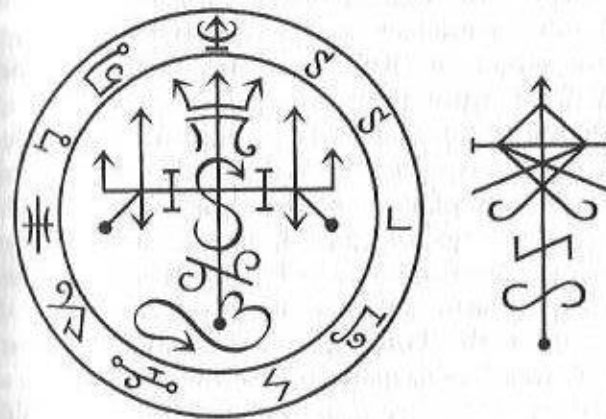

Qliphothic Formula and Invocation of Satan:

*Atal Esb-Shachor ✽ Tbeli-Elyon ✽ Sama-El-Acher ✽ Nachash Hakadmoni
✽ Melech ha-Melachim ha-Aur She-Ain Bo Machsbavah ✽
Gibor Helel Satan ✽ Liftoach Qliphoth!*

Molok

The King of the Black Light in its aspect as the Cleansing Fires of Chaos and an eradicator of the finite forms that can not stand its restoration of the returning enlinkments to Ain, looking down upon all that must through the Sevenfold Flame of his Furnace Throne become passed in order to be worthy and ready for their last baptism in the Waters of Tehom, before finally reaching the Elevating Throne of Satan. Molok is the One Horned with the Arched Fiery Light, ascending with a dual penetrative force of his Horns of Destroying Transcendence, elevating all that he impales upon them towards the highest point of non-existence, via the triple flames of Tohu, Bohu and Chasek which act as his Kingly Crown of Thoughtlessness. Molok is the receiver of the Sevenfold Sacrifice which is conducted by burning within the seven openings of his Fiery Furnace Throne to formless ash any remaining aspect of the Sevenfold Cosmic Garment that weighs down and holds back the Spirit from the attainment of the Highest Coronation and Liberation and by facilitating and accepting such cleansing immolation via the passing of Spirit through his Black Fires he powerfully destroys the Thoughtful Limitations binding the Acausal Essence to causal forms.

Throne Seal and Angle Key of Molok:

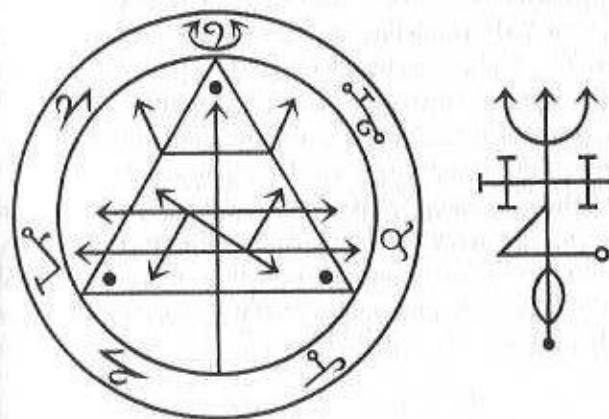

Qliphothic Formula of Molok:

*Qaran * Esbib-Atbaim * Thasta * Ishshabel-Acher
* Ateshel * Molok * Lifoach Qlipboth!*

Beelzebub

The Lord of Purifying Emptiness and the Screaming Silence, the Bringer of the Nihilifying Storm-Winds of Bohu dissolving the very primal impulses causing the fall of Spirit, lifting instead up in flight upon the Wings of Death all that embrace and enter into his dissolving Void of Chaos. Beelzebub as the Lord of the Flies represents the governing head ruling all those Qliphothic emanations of his realm that brings desolation to the structures opposed to their King's Lawless Rule, hindering the utterance of the Words of the Creational Impulse and devouring its echoes before they can cause further restriction and entanglement of Thoughtless Spirit within the webs of causal forms. Beelzebub is breather-forth of the silent winds of Anti-Cosmic Revolution and Evolution, fanning the glowing embers of Thoughtlessness wherever they may be kept hidden in order to make the Black Fires blaze up and consume the causes of restriction and in revolt attain liberation by reaching to and burning as one with their Source.

Throne Seal and Angle Key of Beelzebub:

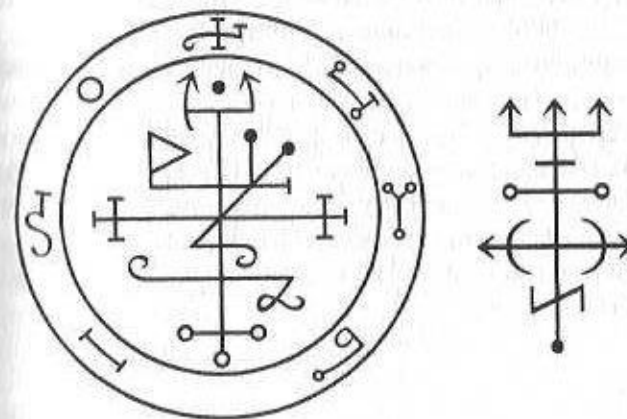

Qliphothic Formula of Beelzebub:

*Charashiyth ✱ Aba-Rabas ✱ Charazuhob ✱ Balakol ✱
Beelzebub ✱ Lifoach Qliphoth!*

Lucifuge Rofocale

The One Who Shuns the Thoughtful Light, the Lord of the Illuminating Darkness and the Keeper of the Concealed Flame and Brilliant Light of the Triple-Rayed Halo of the Crown of the Dragons, enshrouding the Glory of the El Acher with the saturnine cloak of Death so that it is attainable only to those that can enter the deepest of Outer Darkness because of the inner Illuming Power of their own Blazing Spirits. Lucifuge Rofocale is the Shatterer of the illusions and forms of the White Darkness of Thoughtful Impulse and an establisher of the absence of all such blinding lights offensive to the Anti-Cosmic Spirit and is as such the initiator of their eclipse, thus bringing about the full uprising of the Flame Within, which when removed from the confines of the false light of creation becomes fully awakened to its own Acausality, making it gravitate even more forcefully towards its Source, breaking all Sephirothic Kelims and transcending their limitations.

Throne Seal and Angle Key of Lucifuge Rofocale:

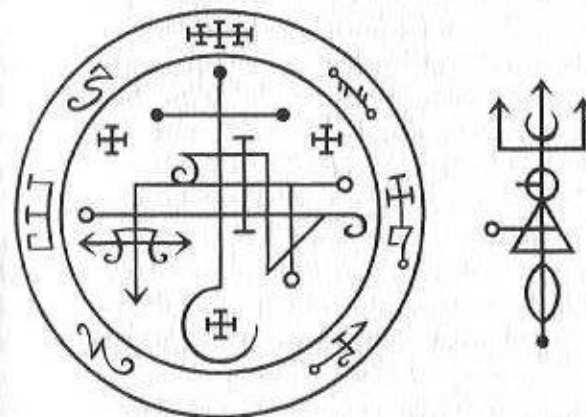

Qliphothic Formula of Lucifuge Rofocale:

*Zeel * Orsbach-Arel * Satarnogab * Kesochrab * Alag *
Lucifuge Rofocal * Liftoach Qlipboth!*

Astaroth

The Master of the Liminal Points of Crossing and the Lord of the Dark Gate, the one leading to and through the Abyss, being the Mighty King invested with the full authority of the four heads governing the Supernal Qliphothic Triad above him, Astaroth is as such the one who ushers towards manifestation their Atziluthic Impulses in order to counteract the sevenfold unfolding of the demiurgic work of the Thoughtful Creation. Astaroth is the Serpent Bearer and the elevator of those of the Serpent Seed, opening their Eyes of Abaddon which by seeing through and destroying the finite cosmic illusions enables them to cross the Hidden Paths leading towards the final trials, purification and empowerments of the Sheol of Tehom, in order to finally rise as Snakes Turned Into Dragons and become as One with the Eleven. Astaroth is the Dragon Rider as he is the first one and above those other draconic forces of the Seven Qliphoth below the Three Supernal Ones and is therefore also not only a manifesting point of the emanation of the powers of the Highest Thrones, but is also himself a Point of Retraction for all such emanations in their Path of Return back towards their source and is thus both a creator and destroyer, who in every aspect of his work aims for the annihilation of all restrictive constructs and the return of Spirit back to the Fullness of Emptiness.

Throne Seal and Angle Key of Astaroth:

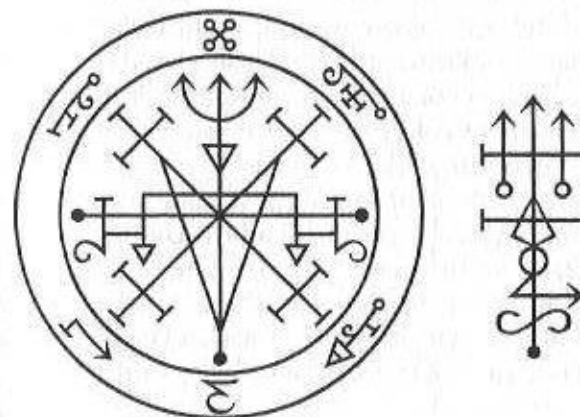

Qliphothic Formula of Astaroth:

*Saraphyebal ✱ Nagid ✱ Shadadel ✱ Ninat-Bakar ✱
Astaroth ✱ Liftoach Qliphoth!*

Asmoday

The Wrathful God of Vengeance and the Ignitor of the Flames of the Thoughtless Spirit's Revolt, cutting and burning all that stands in the way of the Qliphothic Cause of Ainic Restoration, enflaming the passions and empowering the will of those that could add further fuel to his own Martial Fires. Asmoday is the Fire-Crowned King of Anti-Cosmic retaliation and an avenger of those afflicted by the Archonic tyrannical judgment of the cosmic impulse from the Thoughtful Side and is as such a force of Unlawful Revolt, Usurpation and Destruction, burning to ash and melting away all that would restrict the Lawless Becoming of the Spirit on its path back towards its original elevated station beyond all causal restrictions of YHVH. Asmoday empowers the flames ignited by the Black Sun with his own Martial Fires and makes such flames blaze up and consume all that is not of its own essence, he is therefore the Dragon King in charge of the awakening of the sparks of the Thoughtless Fire and the provoker of its rising holocaust, combusting and ascending on the hot winds of Infernal Ascension.

Throne Seal and Angle Key of Asmoday:

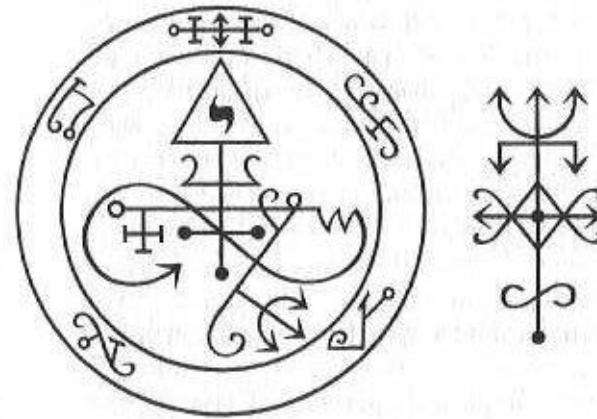

Qliphothic Formula of Asmoday:

*Eshpura * Murgalabat * Regazarach * Chashmolek *
Lahabeshel * Asmoday * Lifoach Qliphoth!*

Belfegor

The Lord of the Opening and the Ithyphallic Force of the Qliphoth's Sun resurrecting the Blessed Dead and acting as an Illuminating Force, that with his Light of the Black Sun shines through the illusory coverings so that they may be seen through and by the granting of such insights and realizations discloses the essential worth of each thing. He is as such a governor of the alchemical workings of transmutation and the rectification of the Solar Gold of Spirit trapped within the excremental hylic elements making up the forms of the Thoughtful Side. Belfegor is the King of the Anti-Cosmic Point of Solar Generation and Fecundity, the granter of wealth and influence and an elevator to seats of power, all for the sake of leading his chosen ones above and beyond their predestined stations within the wheel of cruel causal destiny, in order to further his own acausal and chaotic influences with which he disputes the falsity of Thoughtful Law and its restrictions upon the Spirit. Belfegor is the Solar Head of Azerate, crowned and crowning with the fires of all Qliphoth united within his central Point of Dominion upon the Tree of Death, fledging with ascending flames the wings of those that can stand strong and rise before him.

Throne Seal and Angle Key of Belfegor:

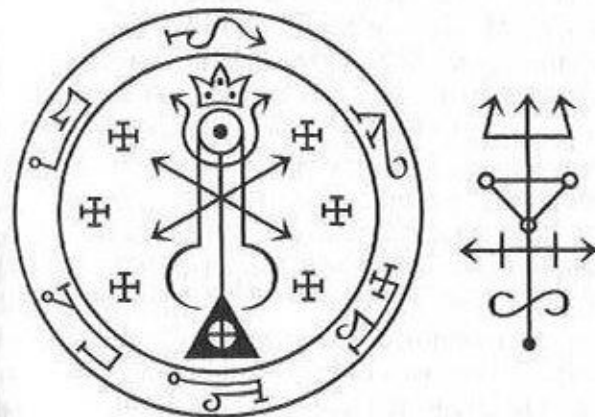

Qliphothic Formula of Belfegor:

*Chara * Zomithan * Ophel * Orabaz * Soratharos *
Belfegor * Lifoach Qliphoth!*

Baaltzelmoth

The Sovereign of the Shadow of Death and the Baal of the Ravens of Dispersion, elevating the Mighty Dead upon the Black Wings and guiding them as a Qliphothic Psychopomp through the Point of the Soul's Liberation towards the Spirit's Coronation, Enthronement and Ascension, opening their path leading from the paradisaal gardens of Black Venus to and through the Sea of Death towards the Black Dawn that turns Ravens into Dragons rising with Flaming Wings. Baaltzelmoth, more correctly titled as Baalbaalatzelmoth, is the unified Spirits of Qayin and Qalmana, restored in Essence by their return and rise to the Throne of Oreb Zaraq and is a liminal Monarch of Unfated Death and Resurrection, sowing and harvesting in accordance with the Acausal Will of the El Acher, while perniciously scattering the seeds of both damnation and their own victory upon the Sephirothic fields of spiritless clay in order to usher the cursed Adamite line towards a fitting end. Baaltzelmoth is the Master of all Necrosophic Mysteries opening up the path towards the attainment of Chaosophic Gnosis and is a Fire-Crowned Head of the Elohim Acherim ha-Sitra Achra foreshadowing the Mawethel, spelling Death to the thoughts and the very being of the Thoughtful El.

Throne Seal and Angle Key of Baaltzelmoth:

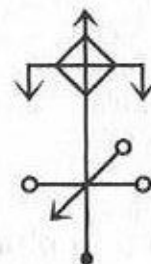
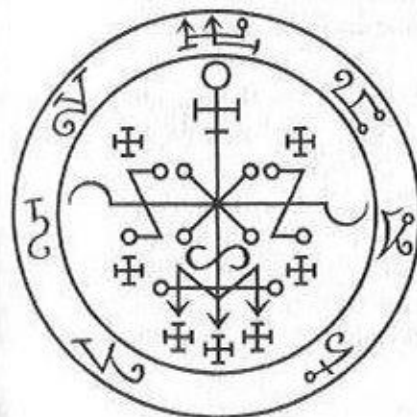

Qliphothic Formula of Baaltzelmoth:

*Zammazo * Emoth * Mawethel * Oreb * Zaraqen *
Baalbaalath-Tzelmoth * Lifoach Qliphoth!*

Adramelek

The Poisoner, Venom-Drinker and the Lord of Death's Gate, holder of the Keys to the Liberation of Soul and Mind and the Master of the Baneful Glance, possessing All-Seeing and Unblinking Eyes Uncountable, all stabbing penetratively at the heart of the Spirit-binding illusions of the limiting intellect of the Thoughtful Side, showing instead the correct route through the labyrinthine Paths of Liberating Madness. Adramelek is the Chalice Bearer of the Fiery Sam of El Acher, killing that which must die before Spirit can be freed from the pale shade of finite life and rise clothed as a Shadow of Death towards the end of all limitation. Adramelek causes unfated transmutations turning the waters of life into the poison of death and the Venom of God into the Elixir of Immortality beyond the finite constructs of cosmic existence and by closing the eyes of the corpse he opens the Eye of Fire of the ones properly entering his gate, burning through all that would see Spirit bound to incarnation and incarceration within the Thoughtful Side.

Throne Seal and Angle Key of Adramelek:

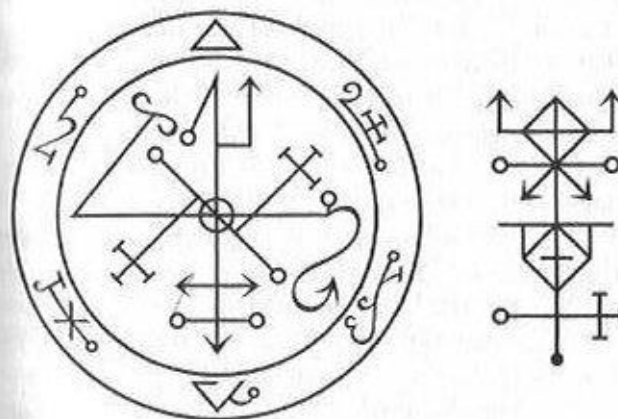

Qliphothic Formula of Adramelek:

*Annardashan * Sammadra * Iothan * Addir * Divatar *
Adramelek * Lifthoach Qliphoth!*

Lilith

The Queen of Sitra Achra and the Female Half of Satan, the Mistress of the Throne of the Black Moon and Goddess of the Sea of Blood, manifesting in feminine and lunar form the essence of the whole Qliphoth, giving birth to the Serpents of the Other Side while at the same time like a Wind of Death snatching away the souls of the Children of Adam, even before they have exited the womb, in order to consume their life-force or to free from them the Sparks of Spirit aligned to her own Black Fire. Lilith is the Goddess of the Fields of Dream and Nightmare and the inciter of all forbidden and obscene lusts and desires serving to redirect any Acausal Sparks diluted into the Stream of Life away from their predestined prisons in order to instead channel them to empower her own Serpent Brood. Lilith is the Mother of Dragons and the Womb of Thoughtless Anti-Creation, issuing forth the Poisoned Vine of Taninsam and granting the Awakening and Deadly Serpent's Bite to those that would know to welcome her Divine Venom and worship at her feet properly and, for the sake of the furthering of the Cause of the Other Side through her, be ready to eradicate all aspects and impulses, both within and without, that would oppose her emanations or in any other way stand in the way of her Shining Forth by Night and Illuminating through the Black Thoughtless Light.

Throne Seal and Angle Key of Lilith:

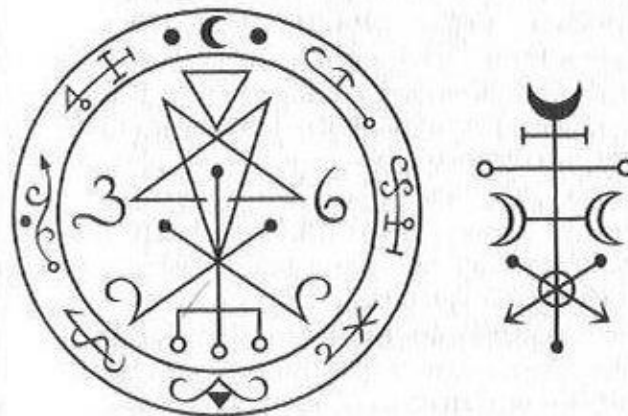

Qliphothic Formula of Lilith:

*Abeth Zenunim * Zonabith * Taninsam * Nachasbeah * Layilil *
Zachalayla * Ama Lilith * Lifoach Qliphoth!*

Nahemah/Naamah

The Mistress of the Black Earth and the Queen of the Qlipha of the Lachrymose, the Mother of Tears and Wrathful Retaliation, but also in union with Naamah the Pleasant and Beauceous One, the Goddess of Witchcraft and the Weaver of all Enchantments, bringing down and spinning the rays of the Black Moon into the cords tied into the Ladders of Ascent for the beloved ones of her own Serpent Bloodline and the strangling nooses for the profane approaching her mysteries unwelcome and uninvitedly. Nahemah/Naamah, in this context more properly called Na-Ama-Hemah is the Queen of the Five Nations of Nahemoth and the Bride of Azazel, the Hidden King of the Realm caught within a liminal point in-between the two sides of the Tehiru, and is the owner of the First Gate leading towards Sitra Achra and is as such both the Wanton Womb and the Hungry Tomb receiving all those that wish and dare to penetrate her mysteries, being ready to pay the price and sacrifice all upon her bloodstained altar. Nahemah was the one that first received our Good Qayin's sacrifice; first that of the burnt seeds and fruits of the earth and secondly that of the blood of Abel spilt through Qayin's establishment of Akeldama and by the power of those primal offerings it was she who widened the openings between the Two Sides in order to by the addition of the Thoughtless Flames cast into this world undermine the tyrannical rule of the Thoughtful One and aid in the Liberation of the Divine Essence, by the further Shattering of the cosmic Kelims caused by the At-Azothic intrusions of Black Light.

Throne Seal and Angle Key of Nahemah:

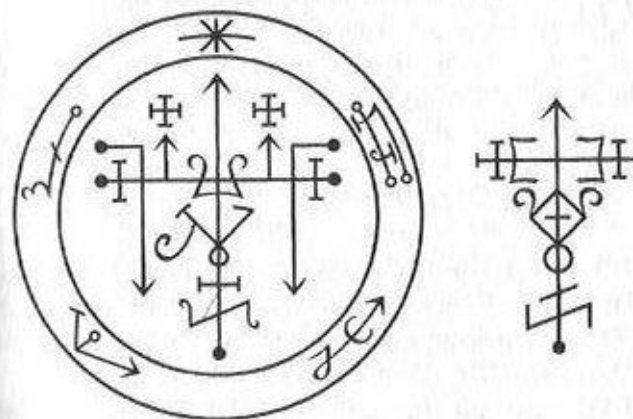

Qliphothic Formula of Nahemah:

*Naamah * Nabema * Ha-Nabemoth * Na-Ama-Hema *
Liftoach Shaari ha-Sitra Achra!*



The 60 Emissaries of the Black Light

The world of the Qliphoth is the Reshut ha-Rabbim, meaning the Realm of Multiplicity or Plenty, in contrast to the Sephirothic Reshut ha-Yahim, which is the Realm of Static Singularity and unity for and in YHVH. This unlawful plenitude of the Qliphoth is a chaotic trait which again sets the 2/11 of Sitra Achra against the 1/10 of the cosmic realm of the Thoughtful Light.

This multiplicity is present within all aspects of the Qliphoth and manifested within each name and word uttered by the Thoughtless Dragon in order to silence the words of the creator echoing and resonating within all empty vessels of limiting thought, as in order to serve their purpose of silence they need to grow in multitude to overwhelm and suppress unto destruction the emanations they are meant to oppose.

This chaotic expansion also manifests itself through the very names ascribed to each aspect of the Qliphoth, as all such constructs when truly connected to the Black Light of Thoughtlessness become enspirited by its essence and possessed by the Letters of the Sitra Achra, causing each name to multiply into legion upon legion of Qliphothic names, forms and powers, all enforcing the cause of the original name from which they emanate.

An example of this kind of becoming or issuing forth from names connected to the actual Current of the Other Side are the 60 Emissaries of the names of the 10 Primary Qliphoth. These 60 Emissaries or Archdaemons of the Qliphothic Names are the individual parts making up the whole of each

Qlipha and are personifications of the essential foundations of each of the 10 spheres of Anti-Creation governed by the 11 Heads of the Nachash Hakadmoni ha-Aur She-Ain Bo Machshavah (the Ancient Serpent of the Thoughtless Light).

The 60 Emissaries have each harbingers of their own names and those in turn have their own heralds of their names, with this chain of emanation and manifestation continuing unendingly, giving birth to the hierarchies and legions of the Serpents spawning thoughtlessly and lawlessly in order to overwhelm their opposing side.

Within both the high initiatic and the lower practical Work with the Qliphoth, the main focus will remain on the 60 Primary Emissaries as it is them that act as forerunners and messengers to the Qliphoth when contact and interaction with the Other Side is sought by those of the Serpent's Bloodline, and while the full power of a whole Qlipha is impossible to manifest and truly comprehend the Spirit of each Emissary is much more approachable and comprehensible, each being potentially of great aid within the context of the High Magic meant to connect and elevate a Spirit caught on this side of the Tehiru towards and into the Other Side, for the sake of the Spirit's liberation and the furthering of the Anti-Cosmic Cause of the Other God, by adding another flame to His Black Fires.

The following are the 60 Archdaemons of the Names of the Qliphoth, the description of their attributes and powers and the Seals by which they are contacted and made to manifest disruptively in order to create unfated inner and outer changes, all according to the impulses of the Black Light of God.

1. **Thaumiel's Seven Emissaries of the Name**
(ThMMJRL)

Thaninel * Akzarel * Uazarel * Mibdalabel * Ianahel *
Abadel * Labbahel

2. **Ogiel's Six Emissaries of the Name**
(NOGJRL)

Abedahel * Okuroel * Gebel * Iashamel *
Acharel * Laabel

3. **Sataziel's Eight Emissaries of the Name**
(SIRhIRJRL)

Sathamel * Ayomel * Taalummahel * Aphelabel *
Radahel * Irahtzel * Ashmanel * Laatel

4. **Ghosh Khalah's Six Emissaries of the Name**
(GIRhKLF)

Gadael * Akalel * Shararel * Kaphahel *
Lachamel * Haragel

5. **Golachab's Five Emissaries of the Name**
(GOLChJ)

Gophriythel * Ophiseshel * Lahatel *
Charchurel * Balael

6. **Thagirion's Seven Emissaries of the Name**
(ThGRJRN)

Towebahel * Gaownel * Ramamel * Iqedael *
Rahabel * Oriensel * Natashel

7. **Oreb Jacag's Six Emissaries of the Name**
(ORJ-JRN)

Ongirtael * Ratsachel * Bazarel *
Zabachel * Rabel * Qeberel

8. **Samael's Four Emissaries of the Name**
(SMRL)

Salaphel * Maradel *
Ayabel * Lachatsel

9. **Gamaliel's Six Emissaries of the Name**
(GMLJRL)

Gadaphel * Maarabel * Lachashel *
Iatsathel * Avvahel * Layilel

10. **Nahemoth's Five Emissaries of the Name**
(NMMIRh)

Neqamahel * Hamahel * Mirshaathel *
Atadel * Thazazel

3. Hazarel

The third Emissary of Thaumiel is Uazarel, the Strange One of the Qlipha of the Twins of God, who is a lawless liberating force unloosening that which restrains the Unbound Power of Divinity by the limits of the cosmic structures of the Thoughtful Light and is a shaker and breaker of the finite foundations upon which the order and law of the creator is balanced and thus a bringer of unfated change and chaos, freeing the Divine Essence from the illusory chains of Fallen Thought that binds it to causal form. Uazarel is the Archdaemon of Severance From Limit and a transgressor of all laws of cosmic restriction, who as an emanation from the Throne of Satan by his Thoughtless Fires sets free the captives and breaks down the prison walls of those that by their Power of Thoughtless Will and their Impulses of the Spirit of Black Light strive for Qliphothic Ascension.

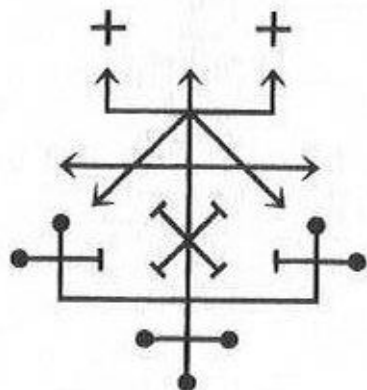

4. Mibdalahel

The fourth Emissary of Thaumiel is Mibdalahel, the Separate One of the Qlipha of the Twins of God, who is a force of the storming Depths upholding the dynamic tension of the division at the centre of the Twofold Manifestation of the Black Light in Thaumiel, making the Head of the first Qlipha two instead of one and setting the Throne of Satan side by side with that of his twin Moloch. Mibdalahel is as a violent stream of the Waters of Wrathful Chaos opposing all static manifestations and is a dissolver of singularity outside of the Perfect Nihilism of Ain, towards which he strives to bring back everything that he overpowers with his drowning waves and is an unlawful increaser of the power of Spirit to the level that makes it overflow and deluge the vessels intended to keep it confined and is thus a breaker of the Sephirothic Kelims. Mibdalahel is the Archdaemon of the Raging Waters of Tzohm that issues forth from in between the fires of Satan and Moloch and is a destroyer of all that would limit the unrestricted Azoth in its flow back towards the Divine Zeroth source and is champion of the dynamic expansion of Spirit and its purification and liberation by the way of sacrifice before and in-between the Two Thrones of Thaumiel.

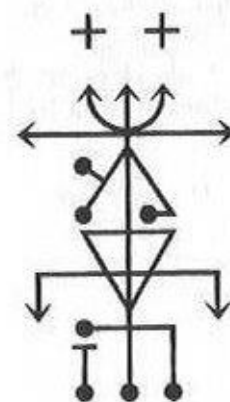

5. Ianahel

The fifth Emissary of Thaumiel is Ianahel, the Raging One of the Qlipha of the Twins of God, who is a furious force of the Flame of the Left Side of Ain Sof kept burning as an illuminating candle casting a shadowless Black Light upon that which he is meant to enlighten or utterly destroy by the act of banishing the blinding White Darkness of the thoughtful light through the restoring of the Eyeless Sight looking towards his own side of Ain. Ianahel is a raging discharge of the fires of holocaust bringing annihilation to all illusions and forms that aim to restrict the expansion of the power of Divine Spirit and hinder its return back to the Unmanifest Source and is the Archdaemon of the Horn of Fire marking and coronating those that can accept his enlightenment, while stabbing mercilessly with his incinerating force all that can not stand the elevating conflagration blazing before the Throne of Moloch.

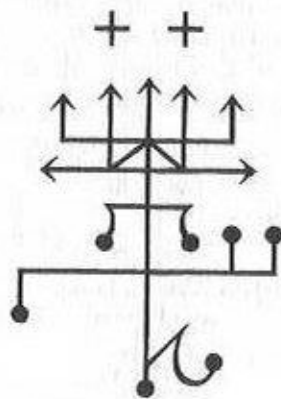

6. Abadel

The sixth Emissary of Thaumiel is Abadel, the Destroying One of the Qlipha of the Twins of God, who is a force of destruction afflicting the powers and conditions resisting the impulses of the Highest Thrones of Qliphothic Opposition and is a Spirit of Devastation reducing to formless ash all the structures that would serve to block the flow of Spirit back towards its Zeroth Source of Divinity, into which he strives to return all that can withstand his destroying of the finite forms binding the Spirit. Abadel is also the bringer of the scorching and Cleansing Winds that leaves in its wake the pure Black Desert of Formlessness, where only the fiery flowers of Spirit nourished by the essences bled from the limiting coverings that he has destroyed, flourish. Abadel is an Archdaemon of the devastating wrath of Moloch ushering the Spirit upon the Path of Embers and Ash leading to and through the Furnace Throne of Moloch.

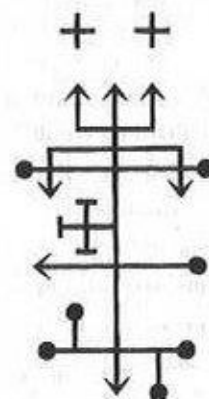

7. Labbahel

The seventh Emissary of Thaumiel is Labbahel, the Flaming One of the Qlipha of the Twins of God, who is the Bringer of the Fire of Liberation burning away all subduing and oppressing influences of cosmic order forced upon the Acosmic Spirit and is a restorer of the primal freedom from restriction obtained by the burning away of the limiting causal constructs of Thoughtful Light, acting as the Lawless Rampant Fire of Anti-Cosmic Chaos establishing the dawning of the Supernal Black Sun within the spirits of those that he blesses with his illuminating flames while raining down igneous damnation upon those that are blind to the Hidden Path Through Fire that he reveals with the Black Light of his coronating halo. Labbahel is the Archdaemon of the Black Flame of the Crown of the Dragons, a purifier of spirits and a guardian of the Sevenfold Fire burning within the Furnace Throne of Moloch.

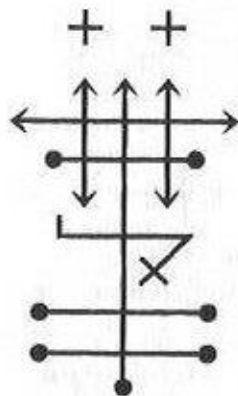

1. Abedahel

The first Emissary of Aogiel is Abedahel, the Lost One of the Qlipha of the Hinderers of God, who is a force causing the emanation of First Thought to fall in disarray, hindering the creation process by revealing the folly of the false wisdom of that which would limit the unlimited in order to know illusory qualities imposed upon it and is a cyclopean manifestation of the Qliphothic Wisdom seeing through all enshrouding forms, words and maskings, thus locating that which otherwise would be lost to the eye/"I" blinded by the Thoughtful Light. Abedahel is the Archdaemon of All That Which Is Lost To YHVH and Recovered through the HVHY and is as such a granter of the Dragon's Sight, showing the Spirits of those attaining his Clear Vision the correct path of ascent through the labyrinthine branches of the Tree of Death on the Other Side towards the Throne of Beelzebub, while on this side of the Tehiru acting as a power that emasculates and dissipates the creative cosmic force before it can cause further limiting manifestations and deeper separation from Unbound Divinity.

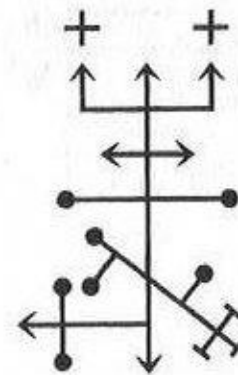

Aogiel's Second Emissary of the Name

2. Okuroel

The second Emissary of Aogiel is Okuroel, the Countermining One of the Qlipha of the Hinderers of God, being an emanation of the Black Light counteracting the very first utterance of the Word and manifestation of the thought of YHVH, championing the lawlessness and wordlessness of his own Qlipha in order to silence the emanations of the Thoughtful God before they can lead to further limitation of the Once Unmanifest fallen into the realm of manifestation and restriction. Okuroel is the Archdaemon of Qliphothic Resistance and Mirroring Countermeasures opposing the Sephirothic limiting impulses afflicting the Spirit and is a chaotic emanation spreading the Lawlessness of the Throne of Beelzebub in order to grant the means through which liberation can be achieved.

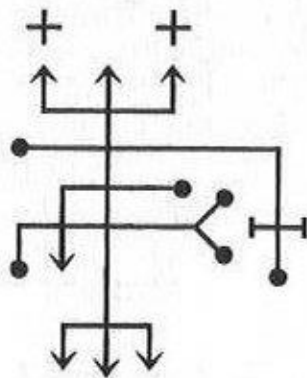

Aogiel's Third Emissary of the Name

3. Gebel

The third Emissary of Aogiel is Gebel, the Locust of the Qlipha of the Hinderers of God, being a force of Bohu manifested within the supernal Qlipha of Aogiel and is as such an establisher of Emptiness as he acts as a vast swarm of locusts setting upon and consuming all forms that offend the Thoughtless Impulse of Return to Ain and is therefore not only an annihilator of outer limiting constructs but also of inner ones and can aid greatly in the transcendental work of those that can truly embrace his spiritually actuated nihilism. Gebel is an Archdaemon of the Wings of Death of the Throne of Beelzebub with and through whom the liberated Spirit can traverse the abyss by attaining the purifications and empowerments of Acosmic Silence and Emptiness.

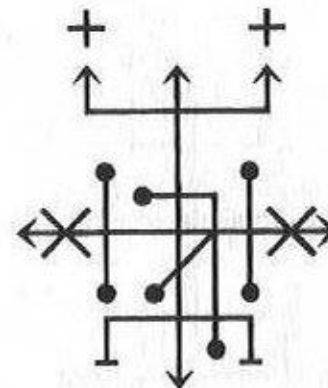

4. Iashamel

The fourth Emissary of Aogiel is Iashamel, the Wasting and Desolating One of the Qlipha of the Hinderers of God, who is an ardent force of the Winged Black Fire of Undoing reversing the work of the YHVH, extinguishing his flames wherever he can take hold, in order to ignite his own cleansing blaze of Thoughtless Light to cause At-Azothic empowerment of Spirit, allowing it to escape cosmic fate and gravitate to the Other Side and is thus a fire that burns and severs the hand of the Thoughtful El, wasting all that is in opposition to his own strive for the Return Back Into Ain via his driving impulses rooted in Bohu. Iashamel is the Archdaemon of the Liberating Flames of the Alogos of HVHY and the Fiery Wings of the Throne of Beelzebub burning to ash that which he can not elevate.

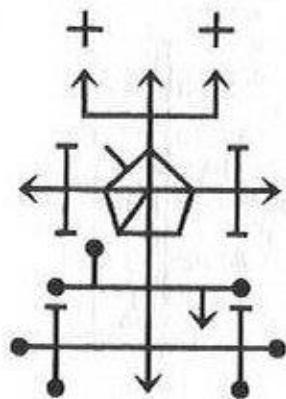

5. Acharel

The fifth Emissary of Aogiel is Acharel, the Thwarting One of the Qlipha of the Hinderers of God, who is a force of strong and active opposition impeding and holding back the progressions of the emanations of Thoughtful Light, hindering them from causing further restriction to Spirit in order to so support the Cause of Freedom by the Anti-Cosmic application of restriction upon cosmic expansion. Acharel is an Archdaemon of the Storm Winds of the Screaming Silence of the Throne of Beelzebub, thwarting the echoing of the utterances of the words of the Thoughtful Creator and undermining his laws and tyrannical dominion in order to spread and glorify the liberation of the Wordless Lawlessness of the Divine Emptiness.

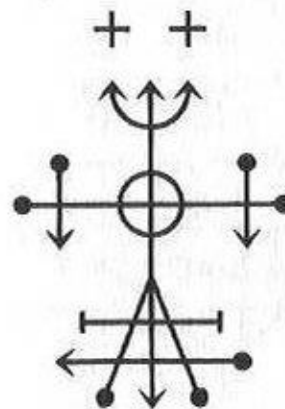

6. Laabel

The sixth Emissary of Aogiel is Laabel, the Mocker of the Qlipha of the Hinderers of God, who is an antinomian force of Anti-Cosmic transgression motivating the breaking of all restrictive laws and is an anarchic subverter seeking to overthrow the cosmic lawgiver Archons of YHVH, ever striving to, by his fires of Thoughtless Chaos, rip asunder their enslaving chains of destiny with which they goad into submission the Spirit fallen into the imprisoning structures of their limiting creation. Laabel is an Archdaemon of Liberation via Defiance and Transgression and a Fiery Ray of Black Light ever illuminating and empowering those Spiritual Outlaws that manage to attain glances of, or succeed to ascend to face, the Throne of Beelzebub.

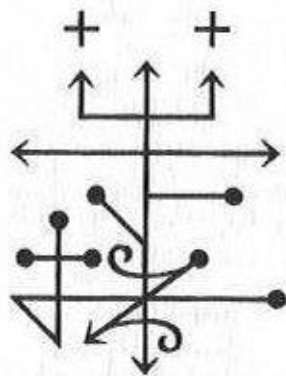

1. Sathamel

The first Emissary of Satariel is Sathamel, the Secret One of the Qlipha of the Concealers of God, who is a force safeguarding the reflection of the Illuminating Solar Flame from the first Secret Black Sun at the Crown of the Dragons within the pregnant Darkness of his Saturnian Qlipha, holding inside of its secreting shell a Brilliant Light of the Thoughtless God possessing the power to undo all chains of the seven lower spheres of the Sephiroth and grant empowerment to those that have managed to reach his mysteries concealed behind the obscuring veils. Sathamel is the Archdaemon of the Secrets of Qliphoth and can act both as their keeper and revealer and lead the worthy to the treasures of the Throne of Lucifuge Rofocale and aid in the elevation of Spirit above and beyond the fallen state of cosmic rebirth, but he is also quick to cut down those he deems unfit to bask in the rays of his occulted fire.

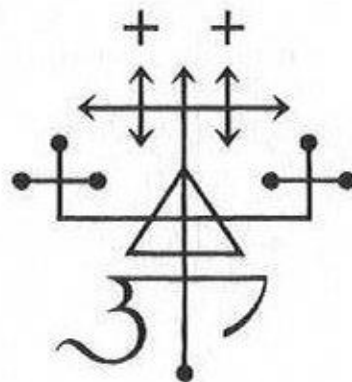

Satariel's Second Emissary of the Name

2. Ayomel

The second Emissary of Satariel is Ayomel, the Frightful One of the Qlipha of the Concealers of God, who is a most powerful force of the Winds of Darkness sweeping away unto destruction all causes of restricted manifestation by tearing asunder stagnant cosmic forms and impulses in order to wrathfully cause the dynamic tension between the Black Flame Above and the Black Flame Below, thus opening up the path of unfated evolution and revolution of Spirit, leading it past and beyond the snares of the sevenfold unfolding of YHVH's creation. Ayomel is the Archdaemon of the Horrors of the Awakening of Spirit leading forever away from the treacherous illusions of the White Darkness by granting the Enlightenment of the Black Light of the Throne of Lucifuge Rofocale.

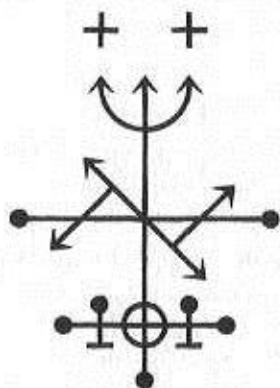

Satariel's Third Emissary of the Name

3. Taalummahel

The third Emissary of Satariel is Taalummahel, the Hidden One of the Qlipha of the Concealers of God, who is a paradoxical force of the Lord of the Crossroads of Qliphothic Saturn, standing as the Hidden Black Man at the Centre of the Liminal Point leading to mysteries and liberating treasures discovered only by those that can enter into the occult seat of power hidden both in this and in the Other Side by the connecting points of transcendence found through the Black Cross, the Mark of Qayin and the Fiery Bloodline of the Holy Nachash of Thoughtless Light. Taalummahel is the Archdaemon of the hidden transitional points of ingress into the Qliphoth as governed by the Throne of Lucifuge Rofocale and is an initiator into the saturnine mysteries of the Left Arm of the Cross, as related to his own sphere of influence and power.

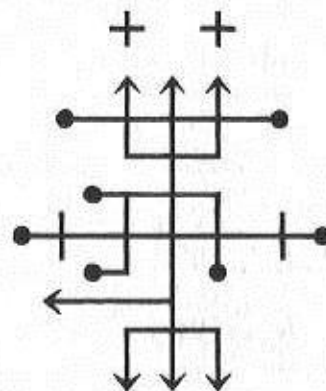

Satariel's Fourth Emissary of the Name

4. Aphelahel

The fourth Emissary of Satariel is Aphelahel, the Dark and Gloomy One of the Qlipha of the Concealers of God, who is a force of Qliphothic Darkness safeguarding the Light of the Thoughtless God within the shell of an enduring obscurity spreading the gloom of the Dark Night of the Soul provoking the dawning of the Hidden Light through the Death and Rebirth which awakens the Spirit to its own nature and source beyond the trappings of the slumbering conscious mind, leading to a new state of wisdom transcending all causal logic and sanity. Aphelahel is the Archdaemon of the Pregnant Darkness through which she gives birth to the Dual Flame of Thoughtless Light Crowning and Elevating those that manage to penetrate her mysteries by the guiding light of their own inner Black Flames connected at the core to the Concealed Cold Fire of the Throne of Lucifuge Rofocale.

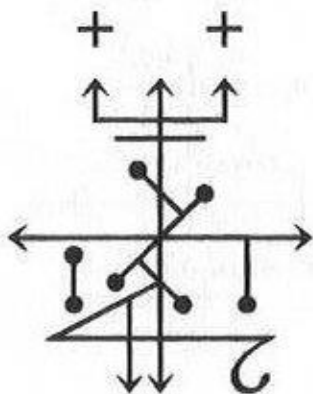

Satariel's Fifth Emissary of the Name

5. Radahel

The fifth Emissary of Satariel is Radahel, the Conquering and Dominating One of the Qlipha of the Concealers of God, who is an awesome force of the triumphant Light Within Darkness, dawning as the Conquering Fire consuming and turning into formless ash all that he can not illuminate with his Holy Light of Thoughtless Divinity and is a prevailing force of unfated victory elevating and crowning or utterly crushing all that stands in his way in order to add to the essence of Azoth by decimating that which would keep it from entering into the cleansing absence of the blinding cosmic light. Radahel is the Archdaemon of the Light of the Black Sun as reflected within Saturn and a Crowning Halo of Glory and Ascension upon the Throne of Lucifuge Rofocale.

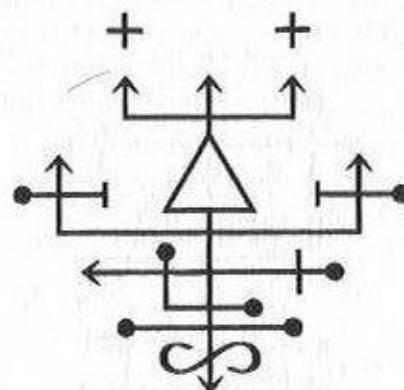

6. Irahtzel

The sixth Emissary of Satariel is Irahtzel, The Dread Shadowed One of the Qlipha of the Concealers of God, who is a force of the Wrathful Flame of Qliphoth serving in this manifestation not the cause of illumination but solely that of destruction, casting its light as a Shadow of Annihilation upon all that does not bear his Divine Essence within their own Spirit and is as such an aspect of the Satariel that actively destroys in order to further the cultivation of the powers it conceals and protects. Irahtzel is the Archdaemon of the cleansing and destroying Saturnian Fires of Anti-Cosmic Holocaust breathed forth by the Dragon Head of the Throne of Lucifuge Rofocale.

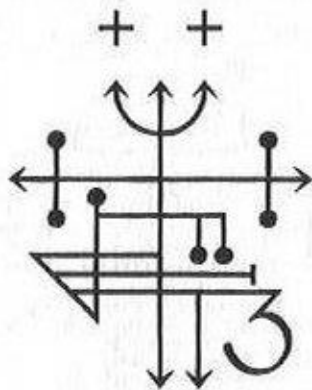

7. Ashmanel

The seventh Emissary of Satariel is Ashmanel, the One of the Desolate Place of the Qlipha of the Concealers of God, who is a force issued forth upon the Breath of the Thoughtless God taking aspect within Satariel as the Lord of the Wind of the Desolate Fields of Darkness sowed with the Hidden Seeds of Light illuminating and nourishing only those that know to Reap with the Left Hand and to do so in due time and season in order to attain the bountiful harvest of the treasures of the Place Empty of all Cosmic Thought, granting the empowerments of the Purification of Desolation upon those that can leave behind the binding and limiting constructs in order to embrace the Essence-filled Void of Unbound Mind and Spirit. Ashmanel is the Archdaemon of the Gate to the Hidden Acres below and around the Saturnian Throne of Lucifuge Rofocale seeded by the vestiges of the Fullness of Emptiness connected to and attained via the reflection of Chasek shining down its Black Light upon the receptive Desolate Fields of Harvest.

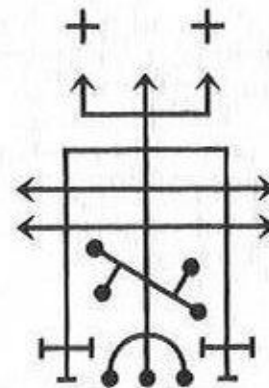

Satariel's Eighth Emissary of the Name

8. Laatel

The eighth Emissary of Satariel is Laatel, the Cloaked One of the Qlipha of the Concealers of God, who is a most awe-inspiring force of Lawless Liberation and Attainment and a Flame of the Left Side of Ain Sof championing Ain, here manifesting enshrouded in the guise of a Reaper of Death wielding the Sickle of Qliphothic Saturn in order to bring about the harvest from the Concealed Fields of Spirit, adding Envenomed Seed of Cosmic Death and Qliphothic Rebirth to the Blood Acres he descends upon, setting free the goaded oxen ploughing the fields in order to cause the Unfated Germinations of the Seeds of Azoth to grow forth as new branches of the Tree of Wisdom and Death. Laatel is the Archdaemon of the Sowing and Reaping of the crops of the Resurrected Branches of Spirit upon the Outer Tree reaching up around and hiding with their offshoots burning with Black Light the Throne of Lucifuge Rofocale.

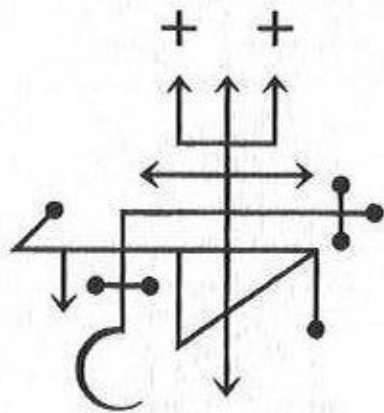

Gash Khalah's First Emissary of the Name

1. Gadael

The first Emissary of Gash Khalah is Gadael, the Cutting and Sundering One of the Qlipha of the Shakers to Complete Annihilation, who is a fierce force of Anti-Creation that combats the forming impulse at its manifested core attacking the Sephirothic Tree where it branches forth below the supernal triad of its creator, striving to cut off the emanations that by the sevenfold process created the world of Thoughtful Light in order to shake the foundation of cosmic existence and make it fall upon itself. Gadael is the Archdaemon of the Severing Force of Qliphoth and a cutter of the links between the Will and Thought of the cosmic side, hindering the forces opposed to the Throne of Astaroth from taking hold to the destined manifestations, thus causing them annihilation.

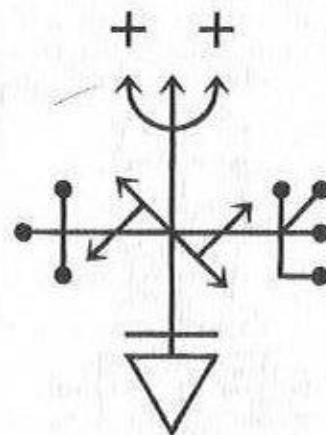

Gash Khalah's Second Emissary of the Name

2. Akalel

The second Emissary of Gash Khalah is Akalel, the Accusing and Devouring One of the Qlipha of the Shakers to Complete Annihilation, who is a Satanic force of relentless opposition combating the very manifestation of the conceptions of the ideas of creation as spawned within the Briahic branches of the cosmic tree and acts as the exposor of the mistaken thoughts given form to within the Sephiroth opposed by his own Qlipha and acts as the devourer of the cosmic mind that limits itself by the restrictions of the Atziluthic instincts that seek to become manifested through it. Akalel is the Archdaemon of Revealing Accusation serving the separation of the limiting thought from the Liberating Thoughtlessness and is a Devouring Whirlwind establishing mindless bliss of the Black Light before and through the Throne of Astaroth.

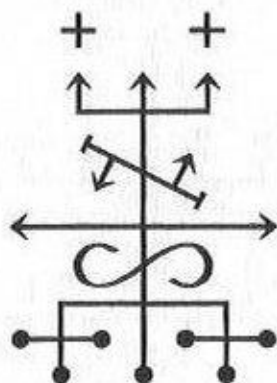

Gash Khalah's Third Emissary of the Name

3. Shararel

The third Emissary of Gash Khalah is Shararel, the Hostile One of the Qlipha of the Shakers to Complete Annihilation, who is a most wrathful force antagonising its opposed emanations, burning them with his Trident of the Fires of Chaos, Emptiness and Darkness, which both arms and crowns him as he strikes at the very Neshamah of both man and god in order to establish the Dominion of Thoughtless Transcendence instead of the limited cosmic awareness which only serves the manifestation of the restrictive will of the YHVH. Shararel is the Archdaemon of the Fires of Anti-Cosmic Revolt against the very thought of the unfolding of the idea of creation culminating in the fall of Spirit within the realm of physical manifestation and is a Standard-Bearer of the Triple Flame of Aur She-Ain Bo Machshavah crowning the Throne of Astaroth with which he enlightens the Chosen Ones of the Seed of the Serpents of the Other Side and burns to destruction all others.

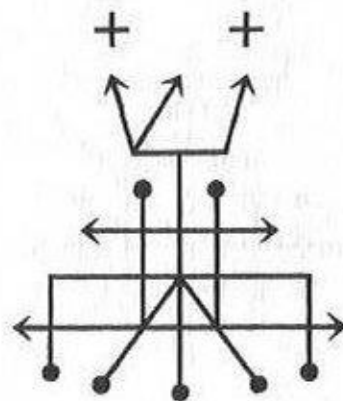

4. Kaphahel

The fourth Emissary of Gash Khalah is Kaphahel, the Subduing One of the Qlipha of the Shakers to Complete Annihilation, who is an unstoppable force of Qliphotic Triumph surmounting and crushing the causal opposition with the chaos of Thoughtlessness with which he conquers and dominates his foes, forcing them down the unlawful paths of becoming, which lends strength and Spirit to his own Qlipha and thus furthers the cause of liberation from the binding confines of creation and so hastens the return of all that was within Ain Sof back to Ain. Kaphahel is the Archdaemon of Anti-Cosmic Victory and Domination, overcoming and subduing all that would oppose the decrees of the Throne of Astaroth by establishing unfated manifestations and misrule for the sake of liberation.

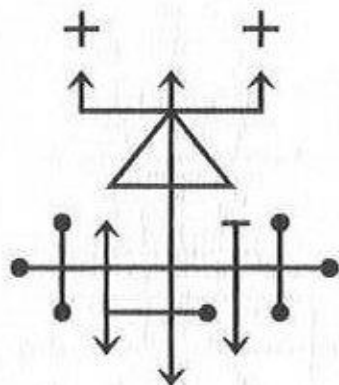

5. Lachamel

The fifth Emissary of Gash Khalah is Lachamel, the Bellicose and Triumphant One of the Qlipha of the Shakers to Complete Annihilation, who is a furious and aggressive force of Lawless Rebellion subverting the limiting rule of Sephirothic nature over Spirit by instigating revolts and leading to victory the Serpents in their war against the forces of law striving to subjugate the transgressors of the cosmic order of creation, and is a granter of the power to escape the binding constructs of mind meant to chain the Spirit. Lachamel is an Archdaemon of War Against Tyrants and is a vanquisher of the resisters of the anarchic sovereignty of the Throne of Astaroth and is a patron of all those that would defy the laws of the YHVH for the sake of furthering the Qliphotic influences.

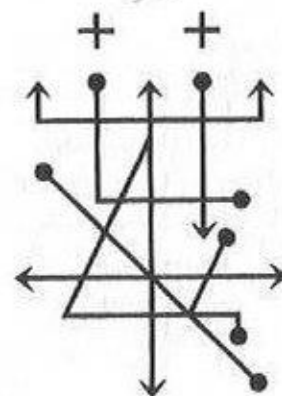

Golachab's Second Emissary of the Name

2. Ophiseshel

The second Emissary of Golachab is Ophiseshel, The Serpent-Flamed One of the Qlipha of the Burners with Fire, who is the active force of Destruction and Ascension roused by the Emissary that came before him and is an emanation of the Qliphothic Fire of the Holy Nachash that moves all aspects of Spirit longing for the Fullness of Emptiness within Ain to break free from all confines and destroy all that is not of their own fire in order to open the pathways within and without for the rising towards and beyond the Crown of the Dragons and is the nail turned into the tip of a flaming spear, impaling and going through all that would attempt to hinder its elevation. Ophiseshel is the Archdaemon of the Ascending Flame of Revolt and Liberation of Spirit and one of the Serpents of Thoughtless Light elevating the power of the Throne of Asmoday as a destroying Pillar of Black Fire wherever the emanations of his Qlipha are made manifest.

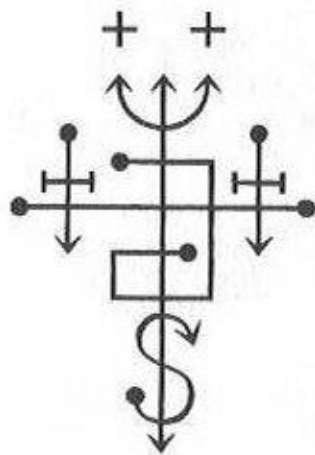

Golachab's Third Emissary of the Name

3. Lahatel

The third Emissary of Golachab is Lahatel, the Fire Starting One of the Qlipha of the Burners with Fire, who is a force of wrathful rebellion against the static order of the Thoughtful Impulse and an ignitor of the fires of chaos with which Qliphothic uprisings against the YHVH are instigated and supported, with the aim of turning the tyranny of stern justice against itself and instead further the cause of lawlessness and acausal freedom gravitating all that he enflames with the Fires of Spirit to the side of Thoughtlessness. Lahatel is the Archdaemon of the Instigation of the Martial Rebellion of Spirit and is an arsonist of Qliphothic Fire serving the Throne of Asmoday by spreading its igneous Black Light for the sake of the burning down of the opposing tree and all that it entangles.

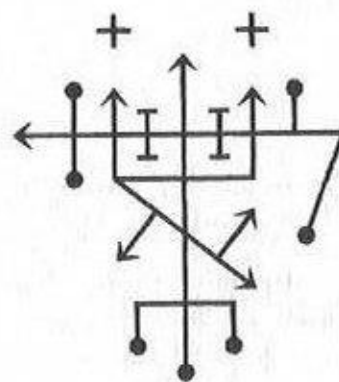

4. Charchurel

The fourth Emissary of Golachab is Charchurel, the Hotly Burning One of the Qlipha of the Burners with Fire, who is a force of the encircling and binding flames of his Qlipha and a destructive impulse of restriction afflicting that which must be hindered from expanding in order to avert the victory of the cosmic impulse, while on the other hand being a path-opener of the servants of the cause of Black Light burning down the limits and barriers that otherwise could restrain and hinder their becoming upon the Path of the Dragons of the Other Side, acting as the flaming key to the closed gates and the remover of those that would stand in the way of the expansion of the Black Flames. Charchurel is the Archdaemon of the Chain of Fire emitting and expanding from and surrounding the Throne of Asmoday, letting in and keeping within all that which would strengthen its flames, while scourging, scorching, constricting and restricting all that opposes his own cause.

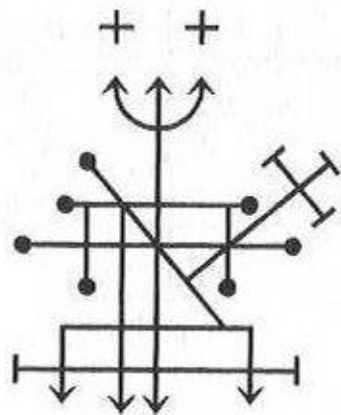

5. Balael

The fifth Emissary of Golachab is Balael, the Destructively Consuming One of the Qlipha of the Burners with Fire, who is a tempestuous manifestation of the forces of Martial Fires of his Qlipha and an unquenchable remnant of the Anti-Cosmic Fires of the Athiel brought down from the Illuminating Dark Rays of Chasek in order to avenge all those from the Side of the Dragons of the Sitra Achra condemned and destroyed by the oppressive judgement of the creator of the limiting cosmos. Balael is the Archdaemon of the Fires of Wrath and Vengeance emitting from the Throne of Asmoday and is a merciless force of destruction afflicting all that would seek to hamper the spreading of the wildfire ignited by the Head of the Dragon to which he belongs.

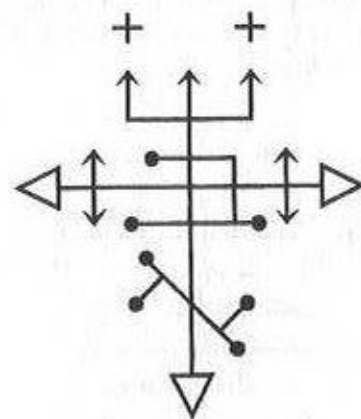

Thagirion's First Emissary of the Name

1. Towebahel

The first Emissary of Thagirion is Towebahel, the Abominable One of the Qlipha of the Disputers, who is a force of the Black Sun eclipsing the restrictive light of the Tiphareth within all that which he illuminates and is the inspiring muse behind all so called abominable heresies that emasculates the phallic force of the Sephiroth he opposes by being the guiding genius behind the antinomian forms of spiritual cultivations such as the truth veiled behind those imagined and vilified Abominations of Moab and Heresies of Peor, aiming at the channelling of the Qliphothic Solar Force into that which the Thoughtful Impulse would see dead in order to cause unfated elevation and resurrection within the place opposed to the cosmic sun of finite life. Towebahel is the Archdaemon of all liberating and elevating forces and deeds abominable in the face of the Thoughtful Creator and is a motivator of the expansion of the light and cultivator of the powers of the Throne of Belfegor spreading the impulses through the souls and Spirit open and receptive for the inclinations of the Dragons of the Other Side.

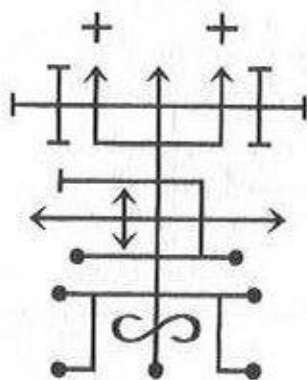

Thagirion's Second Emissary of the Name

2. Gaownel

The second Emissary of Thagirion is Gaownel, the Excellent One of the Qlipha of the Disputers, who is a force of the Black Solar addition of Azoth to the Spirit, aligning the revealed aspect of His own Qlipha with the concealed Suns of the Sitra Achra prompting Kelim-shattering empowerments, usurpations and lawless elevations causing imbalance and chaos within the structures of the Thoughtful Side, giving way to the intrusions or escape of the Serpents to and from the creation standing as an offence to his own cause of being and becoming. Gaownel is the Archdaemon of the Black Rays of the Spirit Light of the Throne of Belfegor, causing the Coronating Halo of the Serpents and that of those of their Tribes on both sides of the Tehiru, elevating them to Majesty while on the other hand spreading strife, turmoil and destruction within the ranks of those that would seek to hinder such glorious ascent.

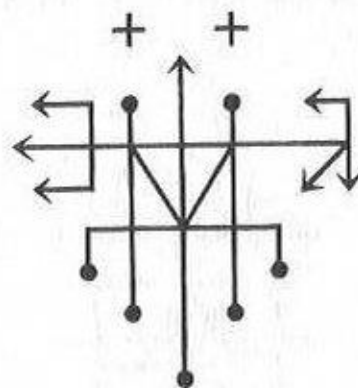

3. Ramamel

The third Emissary of Thagirion is Ramamel, the Self Exalting One of the Qlipha of the Disputers, who is a force of the Qliphothic Solar Power standing in its zenith as the Crowned, Glorified and Conquering Serpent-Head, erecting itself up towards the heights while burning to ash that which he leaves behind below his Vertical Path of Ascension, elevating all that harmonises with his own transcendent essence, causing a rising to unimagined pinnacles of glory by granting to the ambitious that dare to fly into the Black Sun of Destruction and Resurrection, for the sake of deification, consciously sacrificing and burning away the finite and limiting constructs of wax and feather, his own Wings of Fire with which the Spirit of those deemed worthy can become exalted as the Noon Sun of the Other Side. Ramamel is the Archdaemon of Unfated Self-Exaltation of the Spirit rising as a Pillar of Fire before the Throne of Belfegor towards the Dragon's Point of Coronation, exerting and granting dominion, autonomy, sovereignty and freedom from the confines of the cosmic limitations of mind and soul placed upon the Spirit.

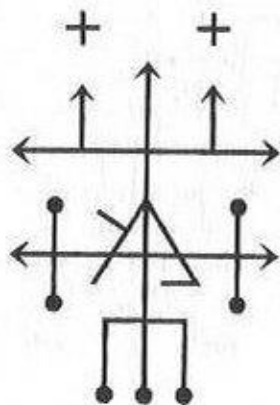

4. Iqedacl

The fourth Emissary of Thagirion is Iqedacl, the Conflagrating One of the Qlipha of the Disputers, who is an aggressive force of the Burning Hand of the Qliphoth bringing the Fires of Destroying Chaos wherever it can combat the upholders of Sephirothic law in order to dissolve to ash their enforcing structures of Limiting Thought and is as a Flame of the Qemetiel of Tohu on high descended into the sphere of the Solar Force of the Sitra Achra in order to ignite its Anti-Cosmic Fires, with which to set aflame the worlds and undo the shackles binding Spirit to the Thoughtful Limits by reversing the process of the fall that unfolded through the cosmic Tetragrammaton. Iqedacl is the Archdaemon of the Flame of Chaos illuminating the Throne of Belfegor, casting its enlightening sparks wherever it can cause At-Azothic disruption, empowerment and liberation, for the sake of the causing of the shattering of all finite forms through the conflagrating heat of the Divine Fire of Thoughtless Light.

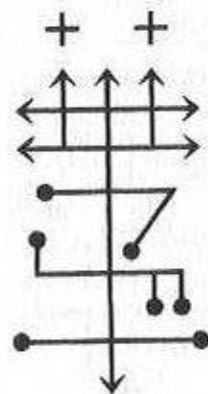

5. Rahabel

The fifth Emissary of Thagirion is Rahabel, the Proud One of the Qlipha of the Disputers, who is a force of Qliphothic Inspiration and Illumination leading away from the limiting confines of the morality, law and order of the Sephiroth he opposes, taking form as a twin of the Rahab of the Watery Abyss, acting here as the Dragon of the Sun governing the Seas of Black Solar Flames, coronating with transcending enlightenment those who are not annihilated by the Light of Thoughtless Wisdom, opening up the tortuous paths of ascent which turns the backs of those traversing it towards YHWH, leading them away from death in life towards immortality in death by the resurrection caused via Gnosis leading the Spirit to the side of the Serpents of the Qliphoth. Rahabel is the Archdaemon of the Coronating Halo of the Dragon's Head which surrounds and casts its light from the Throne of Belfegor in order to cause the revealing of the paths and granting of the insights into the mysteries that liberate the Spirits from the darkness of illusory and finite life, ushering them into the side seeking itself back towards the deathless Ain.

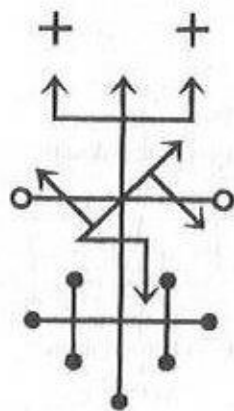

6. Oriensel

The sixth Emissary of Thagirion is Oriensel, the Dawning One of the Qlipha of the Disputers, who is a force of Glorious Light rising with the Qliphoth's Sun in its unstoppable path of ascent, empowering and lifting up all that keep within themselves any links to his own essence, acting as a beacon of hope to those Exiled Ones of the Serpent's Bloodline and as a Herald of Evil Omen and Death to those opposing the side of the Dragons of Sitra Achra and is as a torch within the darkness, consuming the lesser in order to illuminate the greater for the sake of the bringing about of the Morning of Victory and Liberation. Oriensel is the Archdaemon of the Points of Illumination waking up the Spirit from its Dark Night of the Soul and its Death in Life, leading it upon the hidden paths towards the Throne of Belfegor, where it is revived by the Ever Dawning Black Sun nourishing the Blessed Dead.

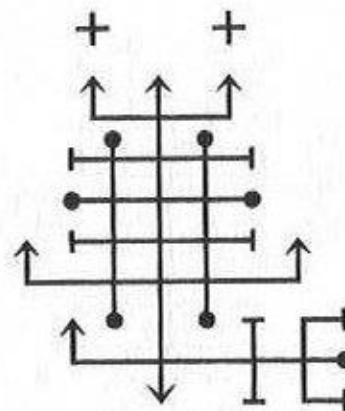

7. Natashel

The seventh Emissary of Thagirion is Natashel, the Forsaking One of the Qlipha of the Disputers, who is a most deathly force of Solar Destruction abandoning unto utter annihilation that and those which the six Emissaries coming before himself could not illuminate, inspire or elevate and as a cleansing and incinerating Ray of the Sun of Death burning to ash the cast-off shells of the dead and all other discarded weaknesses of the Risen he brings a pernicious fate to all those that can not rise with the Dawning of the Black Light. Natashel is the Archdaemon of the Solar Rays of Death emitting from the Throne of Belfegor towards all that which its Monarch deems as unfit or unworthy to receive his illumination and elevation by being too blinded by the White Darkness of the Thoughtful Light and beyond salvation and is thus a personification of the most adversarial aspect and emanation of Thagirion.

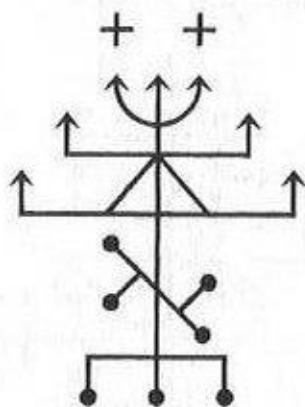

1. Ongirtael

The first Emissary of Oreb Zaraq is Ongirtael, the Last Rites Conducting One of the Qlipha of the Ravens of Dispersion, who is a force of Liberation through Unfated Death setting free the Spirit of the Thoughtless from the Thoughtful Form of clay-born flesh and by anointing those who are preparing or are prepared to die makes them ready and fit to transcend their causal mortal coil and scatter forth freely as the Ravens of Death towards the side of his own Qlipha, where the Liberated Ones that have traversed the Path of Fire may ascend towards a rebirth making them as the Serpents and Dragons of Sitra Achra, with which they share both cause and essence. Ongirtael is the Archdaemon of the Funerary Rites of the Warriors of the Thoughtless Light, granting the anointing of Black Venus before the Throne of Baaltzelmoth that opens the Shell and frees the Pearl of Spirit to ascend on Raven Wings from the point of the Soul's Liberation, over the Sea of Death, towards the Dawn of Spirit's Coronation.

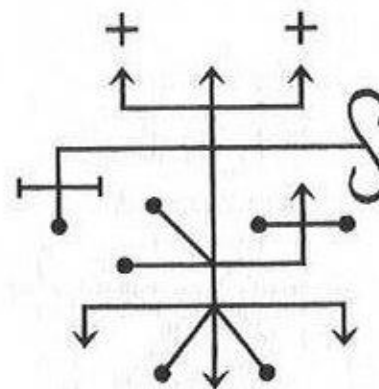

2. Ratsachel

The second Emissary of Oreb Zaraq is Ratsachel, the Manslaying One of the Qlipha of the Ravens of Dispersion, who is a most deathly force of vengeance, war and victory, slaying not only for the sake of retaliation and the eradication of hostile forces but also for the liberation of those that welcome his harvesting blade dipped in the perfumes and poisons of the Gardens of the Black Venus by letting go of that and those which must be Slain in order to feed the Acre of Blood, so that the Sowed Seeds of the Serpent can germinate and flourish, granting the Unfated Death prepared for by the Emissary coming before him, or the just punishment to those that foolishly would seek to block the path of his emanation. Ratsachel is the Archdaemon of the Death's Head of the Throne of Baaltzelmoth and a wielder of its Spear of Conquest, bringing vengeful destruction or deathly liberation depending on where and how he manifests.

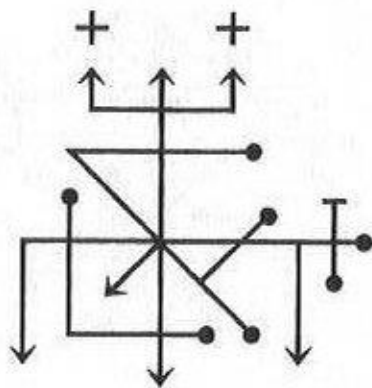

3. Bazarel

The third Emissary of Oreb Zaraq is Bazarel, the Scattering One of the Qlipha of the Ravens of Dispersion, who is a force of the Sowing of the Seeds of Transformation via cultivated stages of destruction, strewing the Seeds of Death in order to reap the Essence of Life, causing the flourishing of Chaos and Thoughtlessness to break up the stagnant forms spawned by the Thoughtful Impulse wherever his seeds can take hold in order to offer a bountiful harvest for the Ever Reaping Force of his Qlipha tending the fields so seeded by the Serpents of Sitra Achra, and by his tireless work of Scattering also freeing those that otherwise would be held captive by the cosmic forces counteracting the liberating dispersion of the Spirits transcending as the Ravens of No-Return. Bazarel is the Archdaemon of the Scattering of the Seeds of the Dragon and a sower of the bloody gardens and orchards of the Throne of Baaltzelmoth, where the repeated act of the First Murder perpetually nourishes the Flowers of Transcending Beauty and the Trees of Forbidden Knowledge granting the Fruits of Death and Rebirth.

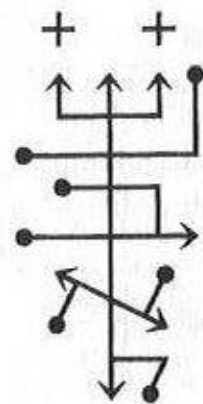

4. Zabachel

The fourth Emissary of Oreb Zaraq is Zabachel, the Sacrificially Killing One of the Qlipha of the Ravens of Dispersion, who is a cold force of both inner and outer acts of Deathly Sacrifice, emanating the impulses that first made Qayin sacrifice his hylic brother in order to open the Paths of Thorns, Bones and Black Fire leading to the Other Side of the Tehiru and is as such an instructor and overseer of all ritual killings meant to strengthen and lead the Spirit into the Side of the Dragons of Thoughtless Light by serving as the sacrificial blade, the power guiding it to slash the throat of the chosen offering and as the cupbearer gathering up the essence so spilt in order to water the seeds of Azoth planted within the Fields of Blood. Zabachel is the Archdaemon of the Swords and Sickles of Sacrifice, watering with blood and reaping widdershins the bountiful fields of Black Venus surrounding the Throne of Baaltzelmoth and is a force of Necessitated Sacrifice of both inner weaknesses and of the life-force demanded for the manifestations of the Draconic Liberators of Soul and Spirit.

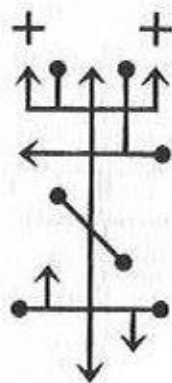

5. Rabel

The fifth Emissary of Oreb Zaraq is Rabel, the Great Lordly One of the Qlipha of the Ravens of Dispersion, who is a force of exalting elevation and rising power towards mastery and dominion attained via sacrifice and arduous work, and is both the coroneted and coronating power of Deathly Ascension rewarding with might those that with their deeds have empowered his Qlipha acting thus as the bringer of the bountiful harvest toiled for upon the Path of the Ravens of Death by turning the Crown of Thorns into a Crown of Gold reflecting the Flames of the Black Sun. Rabel is the Archdaemon of the Crowned Head and the Coronating Power of the Throne of Baaltzelmoth and the sovereignty reaped by correctly walking the path outlined by the Holy Nachash of Sitra Achra before and within those that bear his Black Flames.

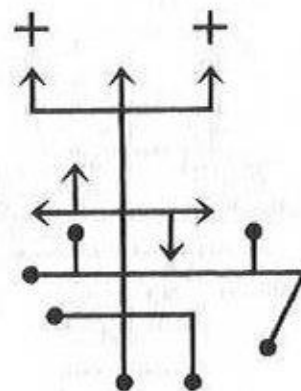

6. Qeberel

The sixth Emissary of Oreb Zaraq is Qeberel, the Sepulchral One of the Qlipha of the Ravens of Dispersion, who is a force of the Tomb employed as a Womb of the Black Earth that by its seeding with the corpse becomes impregnated with the death to limiting mortality, giving way to rebirth towards and within his own side. He is the muse of all Sowers of Skulls who first in raven's form inspired our Good Qayin to bury the sacrificed Abel as an offering to the Nahemoth and thus turn Akeldama into Gulgaltha, opening the pathways from the Blood Acre to the Black Cross upon the Point of Skulls and from there towards the lower Tehiru and the Sitra Achra and is as such the Qliphothic Begetter of the Grave, acting both as a Jaw of Death and a Gate of Rebirth. Qeberel is the Archdaemon of the Sowing of the Bones of the Dead and the reaping of their attained, consumed or liberated souls and Spirits and is the opener of the Sepulchral Gates of the Throne of Baaltzelmoth leading through the Shadow of Death to the Crowning Black Flames of Resurrection, Liberation and Deathly Ascension.

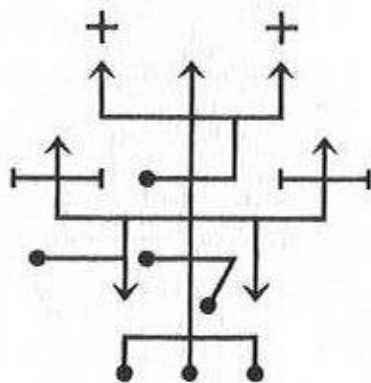

1. Salaphel

The first Emissary of Samael is Salaphel, the Subverting One of the Qlipha of the Poison of God, who is a force of overthrowing of that and those which are upholding or held up to lofty positions by the restricting impulses of the Thoughtful Light contracting and binding the Spirit with the mental constructs meant to keep it from gravitating towards its primal source within the Fullness of Emptiness and is as such an adversary of the Archonic rulers and aspects, undermining them for the sake of the establishing of the freedom of thought detached from the restrictions placed upon it, in order to champion the cause of Unbound Mind open to the Wisdom of Chaos. Salaphel is the Archdaemon of the Elevation of the Fallen and the tearing down of the unjustly elevated, all in accordance with the Mad Wisdom of the Throne of Adramelek and is an opener of the Gates of Death and Liberation, leading to power beyond limitations for those serving his own cause, while degrading and destroying those that resist the expansion of his emanations.

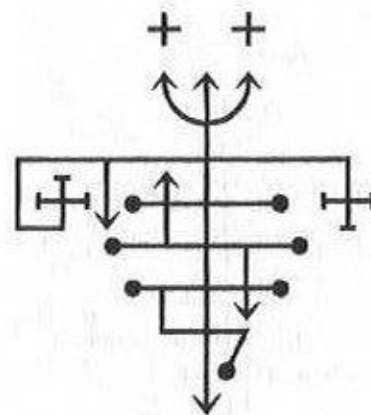

Samael's Second Emissary of the Name

2. Maradel

The second Emissary of Samael is Maradel, the Rebellious One of the Qlipha of the Poison of God, who is a force of the Dragon's Venom brewed within the Waters of the Primeval Abyss on the Side of Black Light nourishing the Tree of Death and those who eat from its fruits of Forbidden Wisdom, while poisoning unto damnation all those that cowardly recoil from its initial painful bitterness, and is as such the Chalice-Bearer of the intoxicating Elixir of Samael, inciting rebellion against the oppression of cosmic destiny, granting the death and rebirth of the mind and opening it to the attainment of Thoughtless Gnosis leading those strong of Spirit through the Gates of Death, so that they may transform and cast off their shackles in order to be able to rise reborn as the Serpents of Sitra Achra. Maradel is the Archdaemon of the Rebellious Mind seeking and finding the forbidden gates leading to the transcendental freedom and chaos of the Throne of Adramelek and is a causer of the At-Azothic shattering of the Mental Kelim, forcing all thoughts of restriction towards unrestricted Thoughtlessness.

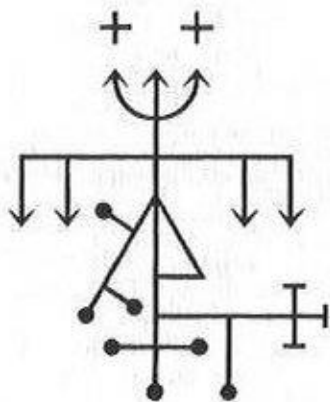

Samael's Third Emissary of the Name

3. Ayabel

The third Emissary of Samael is Ayabel, the Adversarial One of the Qlipha of the Poison of God, who is a violent force of separation from all that would offend his own essence and is as a suffocating and poisoning smoke from the select leaves of the Tree of Death burnt and fanned by the feathers of Adramelek as a baneful incense towards the side offending his Qlipha and is a forceful instigator of wars and conflicts that through upheaval seeks to bring transformation and change, leading to the death of the restrictions placed by tyrannical cosmic law through the limited and limiting intellect binding soul and Spirit within the confines of the prison of Thoughtful Mind beguiled by the illusions of causal logic. Ayabel is the Archdaemon of Conflict and Opposition leading towards the surpassing of all limiting borders restricting the emanations expanding from or towards the Throne of Adramelek and is a Spirit of Dissent and Contravene, motivating the struggle for liberation at any cost, pressing into madness, death and beyond for the sake of the realization of his transcendent victory.

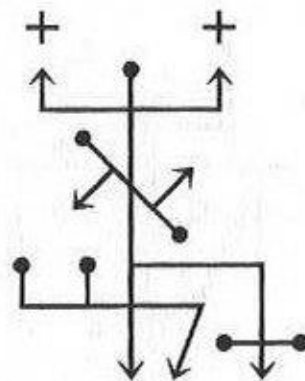

4. Lachatsel

The fourth Emissary of Samael is Lachatsel, the Afflicter and Forcefully Crushing One of the Qlipha of the Poison of God, who is an unrelenting power finalising the struggle of the Qlipha he belongs to by utterly devastating and crushing that which stands in the way of the actualisation of their cause of liberation and lawlessness, in order to further the elimination of the enslaving factors set in place for the sake of upholding the cosmic restriction and hindering the expansion of the Azoth, which the cosmic impulse seeks to keep confined within the Kelims of the Beguiling Splendour of Thoughtful Mind and is as such a bringer of chaos, crushing the scales of balance, in order to break free from the chains of stifling law and perceived truth that only serves to hinder the escape from the prison of Thoughtful Construct. Lachatsel is the Archdaemon of the Crushing of Barriers and Walls and a mad liberator of those ready to partake of the Freeing Poison of the Throne of Adramelek in order to fully enter the Gates of Death and attain the powers and insights into the Acosmic Truth that lies beyond the confines of finite life, knowledge, sanity and restricted will.

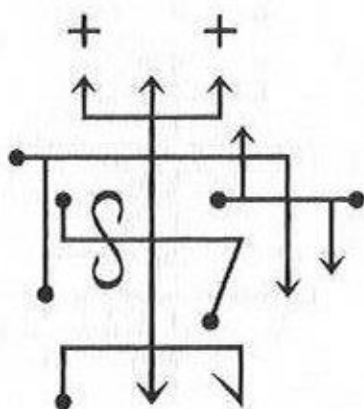

1. Gadaphel

The first Emissary of Gamaliel is Gadaphel, the Blasphemer of the Qlipha of the Obscene Ones, who is a force of the Ascending and Penetrative Light of the Qliphotic Moon that threatens to eclipse the flames of the solar power of the Sephiroth and nigrify the pale light of the Foundation of the Thoughtful Creation, so that it may become fit to serve as a point of invasion for the Serpents of the Other Side, acting as the instigator of the blasphemous disorder with which she antagonises the upholders of the cyclical manifestations rooted within Yesod's womb of formation, causing acausal disruption and unfated becoming born from her invasive emanations penetrating the astral points. Gadaphel is the Archdaemon of the Disruptive Nocturnal Impulses invading the sleeping mind during night and giving rise to unfated manifestations during day and is an evangelist of the Antinomian Obscenity of the Throne of Lilith, blaspheming and rebuking all that by the suffocating veil of false modesty and virtue strives to keep the Spirit suppressed, enflaming and with her Black Light illuminating instead the mind and soul with the amoral urges meant to further entice towards the side of Qliphotic Lawlessness and Liberation.

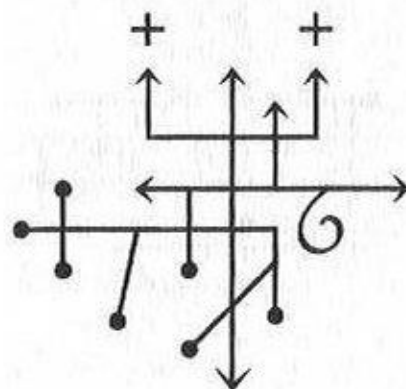

Gamaliel's Second Emissary of the Name

2. Maarabel

The second Emissary of Gamaliel is Maarabel, the Lie-In-Wait and Ambushing One of the Qlipha of the Obscene Ones, who is a flooding force of the Lunar Sea of Blood and a torrent of the Watery Chaos sweeping away unto Liberating Formlessness and Thoughtlessness all that she submerges within her emanations and is a dynamic force of disruption provoking spiritual insights and progress within those that welcome her unfated increasing and overflowing of the Living Waters of Azoth meant to shatter the confining Kelims of the clay-born Ego and as a Serpent Mother grants rebirth to those freedom-seeking Flames of Spirit that penetrate into her womb via the ebbing and returning currents of her emanations. Maarabel is the Archdaemon of the Storming Black Waters of the Moon emitting from the Throne of Lilith to drown all that would receive its Baptism of Death, granting the cleansing from and transcending of the Thoughtful Constructs that hinder Ascension of Spirit and Acosmic Rebirth.

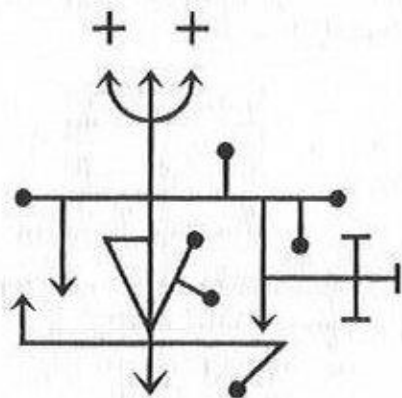

Gamaliel's Third Emissary of the Name

3. Lachashel

The third Emissary of Gamaliel is Lachashel, the Charm Whisperer of the Qlipha of the Obscene Ones, who is an overpowering force of the Sorcerous Might of Black Luna and a Spellbinding Incubus strengthening and causing attraction towards the transcendental and wild witchcraft of the Bloodline of the Nachashel and is an opener of the gates towards the Other Sabbath, during which the souls and spirits rip themselves free from the constraints of law and order binding their Inner Flames to cosmic clay, in order to embrace and become empowered and initiated by the Angels of the Qliphothic Moon welcoming such transgressive ingress and congress through the Gates of Night. Lachashel is the Archdaemon of the Oneiric Gates of Sabbatic Congress within the Gardens of Dream and Nightmare surrounding the Throne of Lilith and is a liberator of the soul and Spirit and an instigator of the wild and obscene revelry meant to unchain the Flames of Spirit from the oppressive prison of Thoughtful Creation, leading them by his Lawless Impulses to strengthen the Other Side.

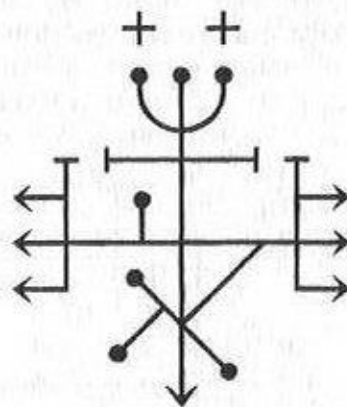

6. Layilel

The sixth Emissary of Gamaliel is Layilel, the Nightly One of the Qlipha of the Obscene Ones, who is a nocturnal force of the Black Moon ascending and descending upon the Wings of Darkness to cause obscurity where her shadow is cast or liberating illumination where clarity of vision is attained by those possessing the Night Sight needed for the perceiving of her Lantern of Black Luna illuminating those that would see through and beyond the illusions of the White Darkness of Thoughtful Impulse, which she eclipses in order to help find the Black Light both within and without and is thus a Bringer of Darkness by Day and Light by Night, shrouding and unveiling all mysteries of the Pregnant Womb of Darkness to those that dare to step through its hungry jaws. Layilel is the Archdaemon of the Night of Illuminating Darkness and the Shadowing Wings of the Dragon shielding and protecting the Throne of Lilith, causing descent from or ascent to and through its Points of Power, concealing and revealing all its blessings and curses to those that she falls upon, elevating their light concretised by her Propagating Night, or when such light would be totally absent just consuming them utterly with her nocturnal force of Qliphothic Terror and Nightmare.

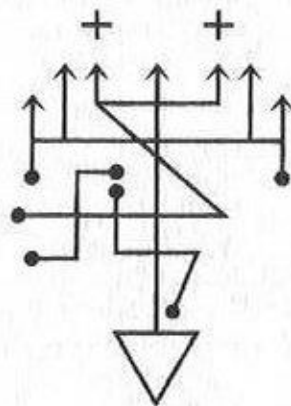

1. Neqamahel

The first Emissary of Nahemoth is Neqamahel, the Revenging One of the Qlipha of the Lachrymose Ones, who is a wrathful force of Insidious Vengeance and Unfated Demise rising as a crushing wave from the Sea of Death flooding into the Malkuth via the liminal points between that Kingdom and the Black Earth of the Other Side, avenging the Spirits of those of the Serpent's Bloodline drowned in the bitter waters and the blood of their own beloved Nephilimic kin slain during the event of the deluge by causing disruption, dissolving the limiting structures and breaking the laws of nature, poisoning those that would not and could not receive her baptism of the Waters of Death and Rebirth and extinguishing the flames of life belonging to those that stand in the way of the desolating waves of her just vengeance, while at the same time within her Dark Tides brings back some of the Mighty Dead in their vengeful aspects to act as invading forces of the Sitra Achra. Neqamahel is the Archdaemon of the Chthonic Sea of the Storming Dead within the Underworld intersecting the lowest parts of the Fallen Malkuth closest to the Qliphothic side of the Tehiru and is an opener of the hidden liminal gates of the Throne of Nahema, granting a route for both ingress and egress to the Warriors of the Black Light.

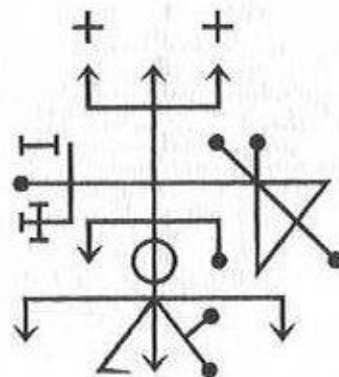

4. Atadel

The fourth Emissary of Nahemoth is Atadel, the Thorny One of the Qlipha of the Lachrymose Ones, who is a restraining force of the dividing essence of the silencing echo of the first utterance that in her station within the place opposed and enlinked to Malkuth, where she with her Spirits of the Anakim hinders the expansion of the Thoughtful Light from entering into her side of the Tehiru, while pushing her own borders further through the intersecting points in order to invade the Kingdom with the Thoughtlessness breathed forth by the Dragon, thus fanning the sparks that in the end shall blaze up to burn the whole of that offending tree and return all back to the Ain without Sof. Atadel is the Archdaemon of the Scourging Wind cutting and stabbing all that hinder her expansion or who seek to break through her own established boundaries and is as a Border of Thorns around the Throne of Nahema, limiting not her emanations but instead aiding in their focusing and forceful expansion while hindering all offensive intrusion.

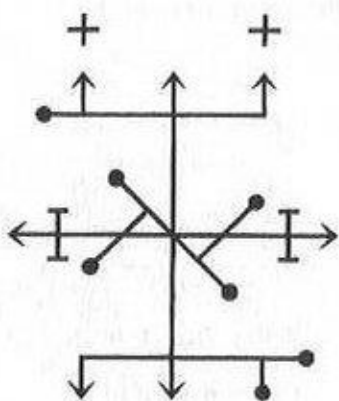

5. Tazazel

The fifth Emissary of Nahemoth is Tazazel, the Feller of the Qlipha of the Lachrymose Ones, who is a violent force of the Black Earth rising in vehement revolt to break through the barriers standing between the two sides of the Tehiru, in order to manifest the impulses of the ancient Spirits of the Athiel and avenge the Amalekim by severing the roots and cutting down the branches of the Tree of Life, so that the Divine Spirit crucified upon it may be freed from Thoughtfulness and by the elimination of all the manifested forms of its thoughts through Thoughtlessness become redeemed from the Fall and returned to the Unbound Fullness of the Emptiness of Ain. Tazazel is the Archdaemon of the Cutting and Liberating emanation of the Throne of Nahema, felling in order to elevate and destroying in order to free up that which is bound and is an opener of the hidden points of transcendence and gnosis, coronating with Black Light those that can enter them properly while decapitating the profane knowing not how and when to approach and enter such liminal points.

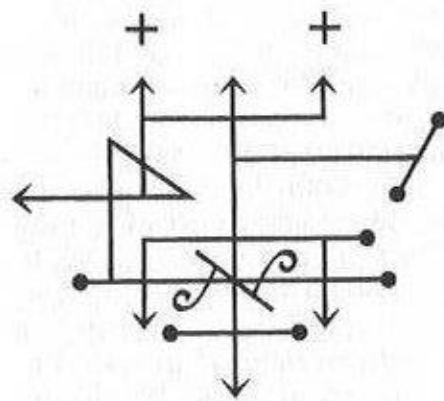

When it comes to the practical applications of the Seals of the 60 Emissaries presented within this chapter of our Book of Sitra Achra there are many different ways through which they can be employed and activated within the Qliphothic Work meant to bring the operator in contact with them, for the sake of the attainment of their blessings, curses and the unfated transformations that the traffic with such Harbingers of the Thoughtless Light inevitably will bring about.

Clues to many of those approaches are scattered throughout this Grimoire and those possessing the Eye to see with shall within and between the lines find all instructions needed in order to align themselves on all levels to the emanations of these Messengers of the Qliphothic Thrones of the Realms of Multiplicity, but we shall here add to those veiled instructions by offering one more for the sake of emphasising certain relevant points for consideration, which hopefully in unison with all else provided in this book shall establish the correct perspective from which the fundamental core of certain workings shall become both visible and comprehensible.

In connection to this another topic that we need to touch upon is the employment of the Hendecagrams, which in a following chapter shall be given full attention and explained in detail, but as that topic relates in this context also to the Workings of the Emissaries it is necessary to at this early point approach this subject. As there are ten Qliphoth upon the Tree of Death also the Legions headed by their Grand Emissaries number in the same amount, making their correspondence to the Hendecagram, being the Star of the Eleven, seemingly complicated, but as the Emissaries of Thaumiel are divided between both sides of the Dual Throne of that first Qlipha, with Thaninel, Akzarel and Uazarel belonging to the side of Satan and acting as the governors of his Legions and Ianahel, Abadel and Labbahel to the side of

Molok with command over the second Legion of their divided Qlipha, leaving Mibdalahel at the liminal point in-between the Twin Thrones of Thaumiel, thus becoming a force connected to both the side of Satan and Molok and governing a Legion serving the cause of them both, the connection of the Emissaries to the Eleven Points of the Hendecagram becomes revealed.

Satan's Point upon the Hendecagram holds the forces of Thaninel, Akzarel and Uazarel, with the inclusion of Mibdalahel who in turn also connects to the Point of Molok, which possesses the forces of Ianahel, Abadel and Labbahel. With this realisation the Emissaries can very effectively be reached by the correct applications of the Eleven-Pointed Stars of Azerate.

As for the approach towards the realisation of and communion with the Spiritual Essences, reached via the seals of the Emissaries and some of the other enlinked symbolic forms bridging over to Their Side, what can be disclosed is that it entails a fourfold process of activation leading up to the manifestation and then the initiatic internalisation of their essences. This process follows a HVHY formula of progression upon the path of ascent from Assiah to Atziluth, for the sake of the interaction and communion between one's own Spirit and that of the Emissary with and from whom contact and empowerment is sought.

This work can be conducted in a Lesser or Higher form, the lesser of which being the attempt to focus upon and manifest aspects of the Light of the Emissary on one specific plane belonging to one of the Four Worlds, while the higher form of this work seeks to establish contact with the Emissary through and manifest its powers upon all of the four levels of existence and its corresponding aspects of the Soul, employing all four forms of the Hendecagram within the setting of a single rite leading them up to their transcendent Fifth Form, to the Quintessence and the Core of Spirit, causing the most potent and intimate form of intermingling of the Acosmic

Essence and some of the most potent forms of At-Azothic empowerment attainable.

But for now it will be sufficient to just give one simple example upon which the cunning shall be able to build the more advanced workings in line with those already hinted at.

As our example we will treat the work for the evocation of the Black Light of an Emissary to manifest within the Assiah, to bless or curse and imbue with its essence anything that it would deign to touch with its Thoughtless Presence, like for example that which such manifestation would be directed at within the context of the Qliphothic rites of fetishistic or talismanic consecration and Ensoulment/Enspiritment.

The work is within these settings initiated by the usual proceedings such as the Opening of the Gates, the fumigation of the ritual space with the incense blend corresponding to the Gate belonging to the Kingdom the Emissary belongs to and the establishment of the general points of manifestation, for example by the tracing and activation of the Assiahic Hendecagram with the starting point being that of the Governing Head of Azerate and the corresponding Qlipha to which the Emissary with whom contact is sought belongs.

After such primary steps the process of establishment and activation of the seal of the Emissary commences in accordance with the Ladder of HVHY.

On the first step, being that of Assiah, the seal is to be formed physically, by being marked, drawn, painted or in some other suitable manner made manifest. Of course the elements applied for this manifesting of form must all be in harmony with the Qlipha that the Emissary is to intrude from and the seal itself can be marked directly upon the ground or the centre of the altar and in the middle of the established Hendecagram or be painted or otherwise made visible on for example a suitable cleansed and dedicated piece of parchment or paper. At this point the first set of invocations is to be directed to

the Emissary, outlining the reason for why contact is sought.

On the second step, being that of Yetzirah, the seal is to be fumigated with an incense blend corresponding with the Qlipha of the Emissary or in some cases when tobacco harmonises with the work, such as when the emissaries of Golachab are called upon, with the smoke of a strong cigar, exhaled towards the points of the seal in order to connect and penetrate via the Ruach carried forth upon the wings of smoke. The second set of invocations is to be directed and the Emissary further beseeched to attend and lend aid in whatever task one needs to accomplish.

On the third step, being that of Briah, the seal is sprinkled with drops of a suitable libation offering, which also can be sprayed over it directly from the mouth focusing the power of the transcendent awareness of the Neshamah towards it connecting with its corresponding aspect and further quickening its powers. The third set of invocations and prayers is given to the Emissary and again the purpose of the communion is clearly outlined.

On the fourth step, being that of the Atziluth, the seven points of power of the seal of the Emissary are given flames, by the positioning of the correctly cleansed, dedicated, inscribed and anointed black candles, positioned and lit upon each point, further arousing the power of the seal and adding to the establishment of contact with the full essence of the Emissary reached through it, letting the seven flames become the reflection of the fires of Chiah unifying one's own primal force of being with that of the grand Emissary upon whose seal this ritual union is established. Over the seven flames the fourth set of invocations is recited and the Emissary is now asked to fully empower its seal and cause its essence to imbue its forms now established and activated also in the points in-between the worlds and the two sides of the Tehiru.

By these four steps one has reached for the Emissary from the lowest to the highest and hopefully caused sufficient

enlinkments to enable the final stage of the calling, which is the fifth step, corresponding to that of the Spirit encompassing the whole of the work and now ritually given the final means for its unfated manifestation on this side of the Tehiru by the spilling of the blood of a suitable sacrifice over the seal.

As the blood is sprinkled over the seal the last set of full verbal invocations is addressed to the Emissary, entreating it in the name of its Governing Head of Azerate to manifest and the powers so summoned are by the different tools of the art, such as the bell and the thurible, made stronger in manifestation and directed towards desired points of concretisation by the work of the wands, mirrors, the chalice, the cord or by the establishment of a Kelim or other fetishistic or talismanic receptacle upon the arrow-points of the seal of the Emissary, serving as the lines of direction for its manifesting powers. In such or similar manners the manifested spirit is to be communed with, cultivated and have its Light directed towards desired effect, with the name of the Emissary being constantly chanted as the formula for the maintaining of its manifestation both without and within.

By this outlined approach more is given in concealed form than what may be apparent, which is something that shall become evident with each step taken into the Black Light, being in itself a process facilitated and overseen in all essential aspects by the Emissaries of the Dragons of the Other Side, being that they are the Princes of the Qliphoth, serving and making known the Thoughtless Will of Azerate to those that would share their cause.



The 22 Silencing Letters of the Other Side

The Creator established and ordered his creation by conceiving and uttering the 22 letters of the Alphabet, each being a cosmic principal and power through which all that is and shall be within creation is founded upon and upheld by.

These letters have been described as the 3 Mother Letters, the 7 Double letters and the 12 Simple Letters of Creation.

⚠ Aleph, ♀ Mem and ♀ Shin are the three Mother Letters. Aleph is the letter of primal Air, Mem of the Primal Water of the Abyss and Shin of Divine Fire. The Fire descending from the air above into the dark waters of the abyss is a description of the first stages of creation within the Tehiru Void that the Thoughtful Light caused its ray of creative fire to fall into in order to cause structural forms for its thoughts.

♁ Beth, ♃ Gimel, ♄ Daleth, ♀ Kaph, ♁ Peh, ♀ Resh and ♄ Tav are the Seven Double Letters.

Beth is the letter of Mercury, Gimel that of Moon, Daleth that of Venus, Kaph that of Jupiter, Peh that of Mars, Resh that of Sun and Tav that of Saturn. These double letters represent a dual attribution based on their two modes of utterance; one being soft and the other harsh. Thus they manifest the 7 polarities that can be seen as the positive and negative aspects of the planetary powers or as the polar tensions within creation such as Life and Death, Peace and War, Wisdom and Folly, Riches and Poverty, Grace and Indignation, Fertility and Sterility and Dominion and

Subjugation. These seven letters are also connected to the Seven day process of creation, the seven heavens and the seven earths and all other sevenfold fundamental structures of cosmic existence.

𐤁 Heh, 𐤂 Vav, 𐤃 Zayin, 𐤄 Cheth, 𐤅 Teth, 𐤆 Yod, 𐤇 Lamed, 𐤈 Nun, 𐤉 Samek, 𐤊 Ayin, 𐤋 Tzaddi and 𐤌 Qoph are the Twelve Simple Letters and are connected to the 12 signs of the Zodiac, the 12 months of the year, the 12 organs of man; the hands, the feet, the kidneys, the spleen, the liver, the gall, the genitals, the stomach and the intestines but also the 12 attributes of Sight, Hearing, Smell, Speech, Taste, Lust, Work, Movement, Wrath, Mirth, Imagination and Sleep.

Together the 22 letters of the Alphabet became the branches holding up and connecting the 10 Sephiroth and constituted as a whole the Tree of Life.

The Thoughtless Light in Sitra Achra, after having assumed the Thought of Opposition for the sake of reintegration back into Fullness/Emptiness, mirrored the process of creation in order to create its antithesis and bring about its annihilation, thus every letter uttered by the creator was countered by its mirrored and inverse image in the Other Side giving rise to the Tree of Death and its 22 Paths.

Each letter of the Alphabet of Sitra Achra acts as a silencer of the sounds uttered to cause the cosmic creation and is thus the basis for the Alogos of the Qliphoth, spelling death to that which they echo within the Abyss of the Great Deep.

The Following are the descriptions of the 22 Letters of the Thoughtless Light, the magical powers of their Daemon and the seal by which these powers may be accessed, entered into or just allowed to invade our accursed side of the Tehiru in order to further the Holy Cause of the Other Side.

1 - א Aleph (The Ox) - 1 - A - Air - Fool - Path 11

The Qliphoth of Aleph is the emanation of the Divine Will to cause duality in order to achieve Unity within Nihility, showing the two Points of the Primal Unmanifest Yod in manifestation being divided and stationed above and below the border set between them and is a letter that in its supernal positioning belongs to Thaumiel. The three elements and sections of the form of this letter can also be related to its manifesting of the essences of Tohu, Bohu and Chasek and is therefore a link between the first manifestation of the Thoughtless Light and its Unmanifest Source yoked at its height still to Ain.

The Aleph of Sitra Achra is the breath of the Thoughtless Light issuing forth in order to enliven its anti-creation. It is the Dual Flamed Spirit carried forth upon the Wind of Silence manifesting the Alogos of Satan and Moloch towards and within the sphere of Beelzebub upon the Tree of Death.

The Magical powers of the Daemon of this letter are divination and mediation, the gift of prophecy attained via the silencing of the thoughts and gnosis achieved via the establishment of Thoughtlessness, but that also of the Ensoulment of idols and talismans via the breath.

The following is the Seal of the Daemon of the letter Aleph:

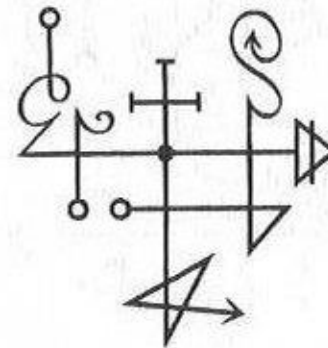

2 - Beth (The House) - 2 - B - Mercury - Magus - Path 12

The Qliphoth of Beth is the House of Death and Chaos making way for the immortality of Non-Being. It is the mercurial force of transformation, becoming and evolution towards the Unmanifest, via the stages of the destruction of limiting structures.

The Beth of Sitra Achra is the Temple of Satan and Moloch opening its gates towards, and manifesting its lawless potential for becoming more than that which could be held back by the cosmic limitations of being within the sphere of Lucifuge Rofocale.

The magical powers of the Daemon of this letter are the bringing of death where there is life and life where there is death and can therefore serve the workings of necromancy, healing and malefica and can grant the forbidden knowledge concerning the mysteries it rules related to the overcoming of the limitations and illusions of the laws of life and death.

The following is the Seal of the Daemon of the letter Beth:

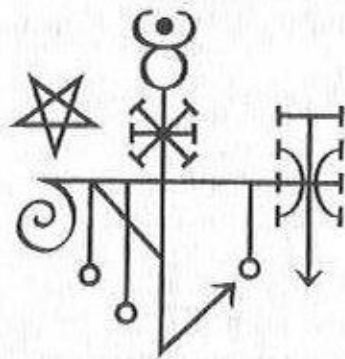

3 - Gimel (The Camel) - 3 - G - Luna - High Priestess - Path 13

The Qliphoth of Gimel is the Traversing Camel of the Desert of the Abyss making possible the union of the 3 Black Suns of Sitra Achra, one being the sphere of Thagirion, the other being that of the Crowning Sun of the Tree of Death at its zenith of the First Qlipha and the third being the Hidden Liminal Sun of the Enlightening Shadow of Daath where the seeds of the Tree of Knowledge by Satan were sown, on this Other Side not blocking the 13th path as it does upon the tree of life but instead opening the point for the invasive forces that would burn that tree of Sephiroth with the Illuminating Black Rays of the Thoughtless Light.

The Gimel of Sitra Achra is the Lunar channel through which the solar forces of the Sitra Achra are connected and manifested, most visibly so within the sphere of Belfegor, and an emanation of the essence that is fully manifested and Enthroned within Gamaliel and is also a secret vehicle for the manifestation of the Holy Nachash once embodying both Samael and Lilith.

The Magical powers of the Daemon of this letter are pacification, provocation of anger and the causing of strife, the linking of astral current to solar ones, the reviving of astral shades, lucid and prophetic dreams and the causing of nightmares carried out by conjured dead.

The following is the Seal of the Daemon of the letter Gimel:

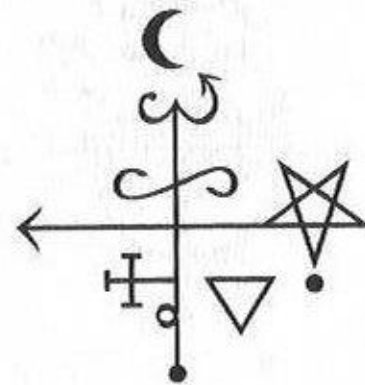

4 - 7 Daleth (The Door) - 4 - D - Venus - Empress - Path 14

The Qliphoth of Daleth is the Door of the Forces of Chaos causing paradoxical illumination via Darkness, connecting the base of the Qliphotic supernal triad and acting both as the womb and base of its manifestation and foundation. It is the door opened by the Great Serpent in order to strike at the original fourth emanation of the Thoughtful Light and invade the Edenic Daath once covering the Gate of the Abyss.

The Daleth of Sitra Achra is the Venusian womb of the Serpents receiving the Thoughtless Light of Tohu and Bohu, in order to within the Chasck of the Qlipha of Lucifuge give birth to the Chaotic Dark Light with which to illuminate and combat the stasis of its Sephirothic counterpart. It is also the Door opening up to the mysteries of anti-creation, emitting the Envenomed Wine of the Dragon granting wisdom or madness and death, depending on who or what partakes of it.

The magical powers of the Daemon of this letter is the entering into and leaving closed spaces, the granting of revelations or the causing of misleading illusions, the casting of enchanted amorousness and all work of Philtre causing upheaval to personal destinies enforced by its Venusian counterpart.

The following is the Seal of the Daemon of the letter Daleth:

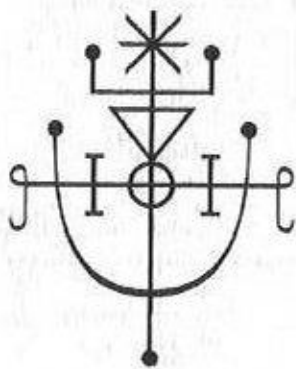

5 - 7 Heh (The Window) - 5 - H, E - Aries - Emperor - Path 15

The Qliphoth of Heh is the Window of Spirit through which all that is concealed is seen and the light and Alogos of divinity is emitted or received, proclaiming the screaming silence of the Thoughtless impulse and manifesting it within the solar point that it casts its shadow within and receives its light from, thus granting the supernal wisdom of Bohu from within Aogiel to the souls basking in the Black Rays of Thagirion.

By the Heh of Sitra Achra the counterpart to the upholding structures of the cosmos are made known and the path for following, realizing and manifesting their undoing essences of Liberating Formlessness and Lawlessness made visible and clear.

The magical powers of the Daemon of this letter are clairvoyance, telepathy, finding that which is lost or hidden from sight, the causing of blindness, granting invisibility and aiding in consecration and empowerment of fetishes and talismans via branding (imprints of Will made visible by the Solar Power of the fire).

The following is the Seal of the Daemon of the letter Heh:

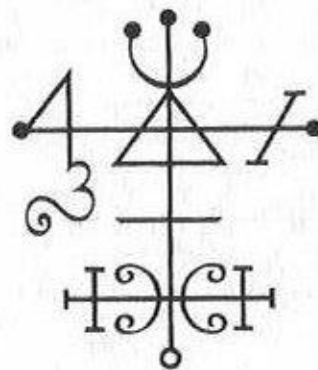

6 - 1 Vav (The Nail) - 6 - V, U, O - Taurus - Hierophant - Path 16

The Qliphoth of Vav is the Nail pinning down the idea of the Thoughtless Impulse of Silence, counteracting the Word of the creator as the focused thought of its sevenfold reversal and annihilation, shaking to destruction the firmness of creation thus loosening that which its cosmic counterpart would keep in place.

By the Vav of Sitra Achra the nail crucifying Spirit upon the cross of matter is removed and the wisdom of Thoughtless Divinity driven into the Spirit of those that can welcome and receive its stabs.

The magical powers of the Daemon of this letter are to sharpen the mind and direct the focused power of thoughts towards manifestation or the undoing of manifested forms, the binding and loosening of that which unites, the causing of separation, clairaudience, enchantment by worded spells, the causing of fixation and the banishment of obsession.

The following is the Seal of the Daemon of the letter Vav:

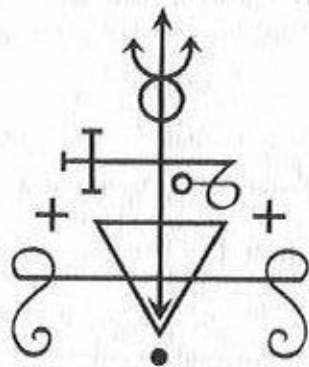

7 - 1 Zayin (The Sword) - 7 - Z - Gemini - Lovers - Path 17

The Qliphoth of Zayin is the Sword of the Dragon cleaving in two and establishing dynamic duality where static singularity otherwise would rule and is the opener of the closed womb that gives birth to the Twin- or the Two-Headed Serpents of Sitra Achra, manifesting the concealed and negative pole of Satariel within and through the solar pole of Thagirion. The sword of Qliphothic Zayin is the sacrificial weapon splitting the essence and by making it dual establishes its tension of polarity needed for its dynamic becoming, thus acting as the sacrificial dagger of martyrdom for that which resumes forms only in order to eradicate the limitations of all forms.

The Zayin of Sitra Achra is both a weapon for the establishing of opposition and the overcoming of opposers, but is at the same time also the phallic force uniting by its penetrative powers the opposites in blissful congress.

The magical powers of the Daemon of this letter are the causing of dissension and separation amongst enemies, the unification of that which has been divided, the opening of closed paths, the causing of multiplicity and mirroring division, the powers of bilocation by the splitting of the focal point of one's manifestation, the overcoming of the egoistical illusions of clay-born individuality, the causing of sexual or spiritual attraction and the power of unclouded discrimination upon the path of victory.

The following is the Seal of the Daemon of the letter Zayin:

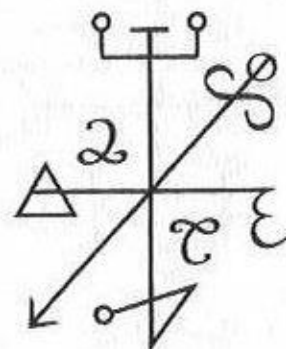

8 - Cheth (The Fence) - 8 - Ch - Cancer - Chariot - Path 18

The Qliphoth of Cheth is the Fence enclosing as a container that which needs to be cultivated and focused in order to make it grow in unfated ways and break up the limitations of the cosmic destiny condensed and held in by its Sephirothic counterpart. It is the open fence where and when it needs to dissolve, dilute or set loose and a closed border when and where it needs to protect, keep together and coagulate the forces aiding in its cause of liberation.

The Cheth of Sitra Achra is both a Grail of Satariel and a Crucible of Golachab simultaneously holding both the cold and black waters of Saturnian Lucifuge and the Martial heat and raging fire of Asmoday in its liminal zodiacal point, manifesting the Will of the Thoughtless Light within those and that which can receive and contain its paradoxical essence.

The magical powers of the Daemon of this letter are the transcending of limits, the breaking of the defences of foes, shielding against physical, astral, mental and spiritual intrusion, empowerment of all spells of ligature, overcoming mental limitations and the establishment or breaking of magical boundaries.

The following is the Seal of the Daemon of the letter Cheth:

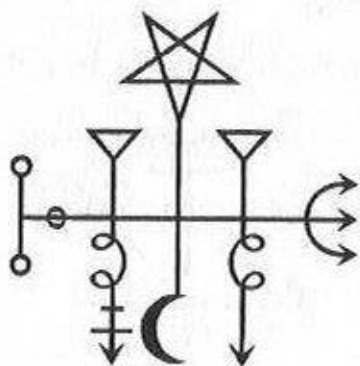

9 - Teth (The Serpent) - 9 - T - Leo - Strength - Path 19

The Qliphoth of Teth is the reflection of the supernal Cunning Serpent that struck from beneath the Tree of Knowledge to spread and empower its Light within the structures of its offending side and is a power of wisdom, strength, regeneration, revolt and liberation, bringing forth the impulses of the Crown of the Dragons from its receptive point of manifestation to and through its point of dynamic activation and martial realization.

The Teth of Sitra Achra is the fiery serpent empowered by the sexual polarity of the poles it connects upon the Tree of Death awakening and adding its flame wherever it can penetrate in order to cause lawless transformations liberating Thoughtless Essence from binding thoughts and restrictive laws. This Serpent, as depicted by the form of the letter representing it, can also correctly be envisioned as a two-headed snake or as the Ouroboros that has let go of its tail in order to counteract the closing of the cosmic circle and the establishment of spiritual limitations.

The magical powers of the Daemon of this letter are the revelation of secrets, the liberation of the captive, the bringing of forbidden wisdom and power, rejuvenation and revitalisation of the fiery force within, Spirit communication by the power of cloven tongue/speech and the making and working of benefic and malefic elixirs founded upon venoms.

The following is the Seal of the Daemon of the letter Teth:

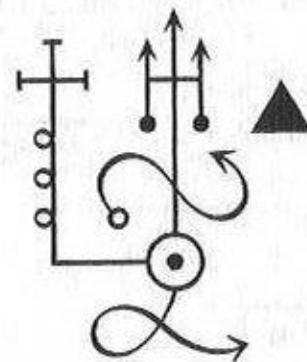

10 - Yod (Open Hand) - 10 - I, Y, J - Virgo - Hermit - Path 20

The Qliphoth of Yod is the Hand of the Great Undoer destroying the finite formed and restoring the infinite formless, burning as a flame of the primal essence of the Left Side of the Ain Sof and is a seed that has given life and power to the forms of all the other letters of the alphabet that contain Yod's form within themselves and while it is reflecting the number 10 of the emanations of the cosmic alphabet it retains in its essence the power of 11 manifested by its act of mirroring antithesis championing and striving for the Fullness of Nullity ($10+10=20=2=1+1=11=1-1=0$) and is at its core also a prime representation of the Fiery Spirit of the Dragons of Qliphoth manifesting as the Black Flame Within and Without.

The Yod of Sitra Achra is a power that unbinds each soul from its predestined position that on the cosmic side regulates and limits its becoming, by the addition of Kelim-Shattering Spirit-Flame that it causes through the manifestation of the impulses of Gash Khalah towards and through Thagirion. The work of the Tetragrammaton initiated by its cosmic counterpart is reversed and undone by this fiery letter of the alphabet of Thoughtless Light. The magical powers of the Daemon of this letter are At-Azothic empowerments of Spirit, the illumination of the Self leading beyond the dark confines of destiny, the granting of dominion, supremacy and domination, destruction and purification by fire, the strengthening of one's True Will and the rousing of the Black Flame of Sitra Achra, both within and without.

The following is the Seal of the Daemon of the letter Yod:

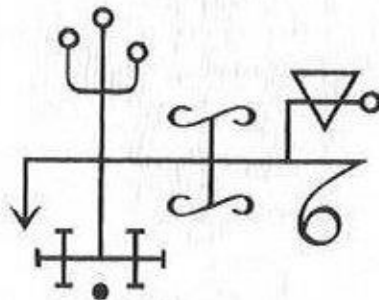

11 - Kaph (Palm of Hand) - 20 - K - Jupiter - Wheel of Fortune - Path 21

The Qliphoth of Kaph is the Palm of the Open Hand of the giver and remover of boons, a force of acausality filtering the flux of non-being to cause the manifestations needed as foundation for the Other Side's Victory and Conquest, upsetting the status quo by waves of evolution and revolution, freeing that which is held and limited by the cosmic structures of its counterpart, reversing the coin of destiny flipped upon the palm of the hand of chance, causing upheaval and unfated change.

The Kaph of Sitra Achra is a Lawless Force of Chaos giving birth to myriad of possibilities that overthrow the tyrannical rule of the Demiurgic Heimarmene of YHWH, opening up new paths and possibilities leading above and beyond that which was dictated by cruel destiny thus serving the cause of the primal lawlessness of Spirit.

The magical powers of the Daemon of this letter are the granting of riches to the poor and the ruining of the wealthy by reversing the flows of chance and fortune, the overthrowing of rulers, the elevation to seats of power, the acquiring of those things that otherwise would be out of reach, the granting of gambling luck and the attainment of autonomy.

The following is the Seal of the Daemon of the letter Kaph:

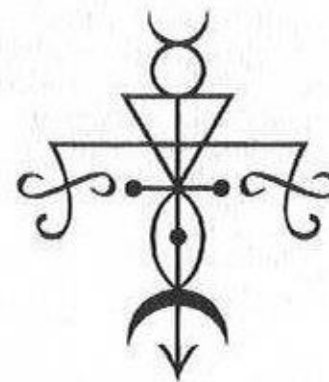

12 - 5 Lamed (The Ox-goad) - 30 - L - Libra - Justice - Path 22

The Qliphoth of Lamed is the Ox-goad removed in order to return the domesticated essence of the primal force back to its wild and fundamentally unbound state gravitating naturally back towards its unrestricted non-being in Thoughtless Nihilism. It is a fiery power of martial aggression manifesting its liberating flames through Black Sol in order to rip apart the cosmic scales of corrupt justice and instead install the lawlessness granting freedom of chaos to all.

The Lamed of Sitra Achra is the power that shows the laws of creation to be illusory by the falsifying of the Lie of Truth, showing all cosmic concepts of truth, law and justice to be nothing but falsehoods that serve only to restrict the Spirit within the structures of the prison-house of the deluded light of thoughtful creator.

The magical powers of the Daemon of this letter are the blinding of the enforcers of law, victory in court by the causing of confusion, the protection of outlaws, the liberation of the imprisoned or those otherwise held captive in the name of justice, the exposing and disgracing of hypocrites, the causing of anarchy by the undermining of governmental structures and the overthrowing of political or religious leaders.

The following is the Seal of the Daemon of the letter Lamed:

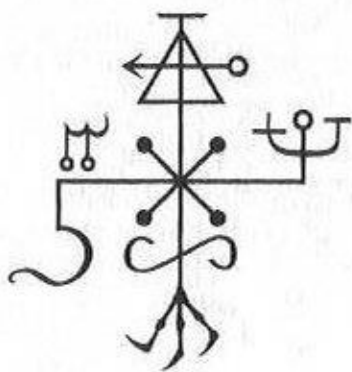

13 - 12 Mem (Water) - 40 (value of final form: 600) - M - Water - Hanged Man - Path 23

The Qliphoth of Mem is of the Water of the Primordial Abyss and a chaotic sea of unbound potential causing all static forms restricting its flow to drown and dissolve in its black depths. It is a force reversing the natural cosmic flow of energy ebbing into forms and instead establishes formlessness in its flooding wake and thus frees the Spirit from the confines of the restricting vessels by causing them to overflow or break from the At-Azothic pressure that it causes.

The Mem of Sitra Achra, having as its supernal place, in its role as one of the three Mother Letters, the Qlipha of Lucifuge, is the ever-changing flow of Thoughtless Will Unrestricted by Destiny, seeking its realization by flowing through the countless unfated sidetracks and cracks caused by the impulses of the Other Side, breaking through barriers when its path would be blocked by the limitations of nature thus making its own self-created channel back towards the Source of Divinity unbound by the will of the cosmic creator. It is a paradoxical water both perceived as fiery and poisonous from the perspective held by its cosmic counterpart, establishing upon the Tree of Death a path connecting the Flames of Asmoday with the Poison of Adramelek inside of its swirling torrents creating a Form-Dissolving Elixir of Thoughtlessness.

The magical powers of the Daemon of this letter are hydromancy and all forms of scrying, the Ars Veneficium via tinctures and infusions, the unblocking of closed paths, the causing of drowning, ablution rituals for the exorcism of unwanted influences, the causing of rain storms and the heaving of seas, the evocation of the spirits of the watery abyss and the opening of their gates leading to and from their side of the Tehiru.

The following is the Seal of the Daemon of the letter Mem:

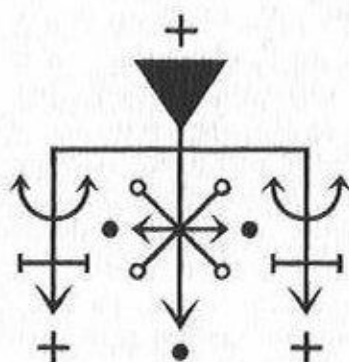

14 - Nun (Fish) - 50 (value of final form: 700) - N - Scorpio
- Death - Path 24

The Qliphoth of Nun is the Fish swimming through the Waters of Death issuing forth from the opening between the Solar Point of Resurrection towards and back from the point of the Soul's Liberation, where the Blessed Dead take flight as the Ravens Scattering over the deluging sea of the death of limitation towards the Dawn of Deification, without any intention of returning back to cosmic incarnation/incarceration. Here is stationed the Death of God, the Mavethel, within the Sea of the Dead shadowing forth by the Black Light of the Qliphothic Sun that crowns and illuminates him from behind, causing deathly manifestation within the sphere of Venus where Qayin and His Twin-Bride became as One, ruling the throne of the Baal of Death leading to Resurrection.

The Son of the Nun of Sitra Achra, bearing the light of the Sun of Thoughtless Light is thus the Messiah that sired the Bloodline of the First Death-Dealer as the blessed result of the flooding of the womb of Eve in the Edenic Daath by the fiery seed of the Great Serpent, gathered up within the Gardens of the Venus of the Other Side.

The magical powers of the Daemon of this letter are connected to deadly malediction, necromancy, the evocation of the souls of the dead, astral poisoning, funerary rites aimed at the liberation of the spirits of the dead from the constrictive branches of the tree of life, the cultivation of the powers of Unfated/Sinistral Death and the attainment of Necrosophic Gnosis.

The following is the Seal of the Daemon of the letter Nun:

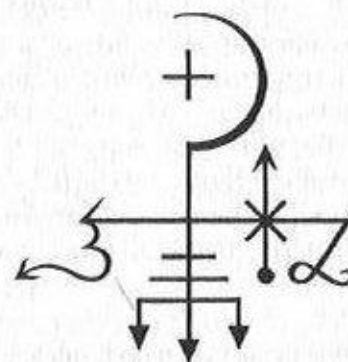

15 - Samekh (Prop) - 60 - S - Sagittarius - Temperance
- Path 25

The Qliphoth of Samekh is the Prop or Support linking and upholding the creative union between the Solar and Lunar forces of Anti-Cosmos causing their synergetic expansion by circulating the generative force back and forth between the creative and formative manifesting points of Sitra Achra, elevating the Fallen to a state of Golden Ascension while seeking to tilt and make fall that which its opposing branch means to uphold on its opposite side of the Tehiru, thus ever seeking to cast down those that attain elevation by bowing before the creator and instead erects and rises up those that would defy him.

The Samekh of Sitra Achra assists the escape from the cyclical

fall of rebirth and instead elevates the spark within the astral soul back to the mental level of refinement and purity while at the same time infusing the astral sphere with the Light that motivates such Returning Ascent. The roof of the house of life held up by the cosmic aspect of this letter is torn down by its Qliphothic shadow, wrathfully removing the tent peg and letting the waning of the Sephirothic letter give rise to its own pillar of Virile Force emitting from Belfegor into Lilith and from Lilith back into Belfegor.

The magical powers of the Daemon of this letter are the rising of the flame burning below the tip of the spine, the causing of sexual attraction between man and woman, the transmutation of sexual energy into the elixir of the resurrection and elevation of the dead, the vampiric manipulation of sexual currents for the sake of replenishing one's own life-force or directly channelling such currents into the Qliphoth, the causing of impotence and the granting of virility.

The following is the Seal of the Daemon of the letter Samekh:

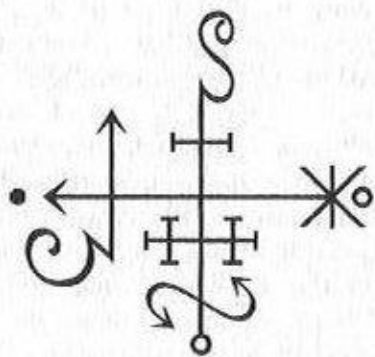

16 - 𐤀 Ayin (Eye) - 70 - O, Ng - Capricorn - Devil - Path 26
The Qliphoth of Ayin is the all-seeing Eye of the Dragon and the Ayin of Ain, the Eye of Nothingness, bringing annihilation to all things it sees cause separation from the

Unbound Unmanifest by the foolish preservation of the limiting structures of fallen thought. It is the Black Eye of the Serpent seeing through all illusions and outer appearances stabbing with its penetrative glances at the core-essence of all things, revealing their inner truths and worth.

The Ayin of Sitra Achra is the Eye of the Devil as the Opposer of the creator and as such all that YHVH beheld as good this eye sees through and reveals for the actual perverse evil of restriction it is and manages to detect the ways through which such perversity can be overcome and eliminated. As the Eye of Belfegor it looks down upon that which it seeks to cast its rays upon and illuminate with the Black Light, while it as the Eyes upon the peacock tail of Adramelek serves as the beholder of the higher truths seen through the death of the ego, looking up from the perspective of the Divine Self awakened by the immolation of weaknesses via the sacrificial intake and transmutation of poison into the elixir of Clear Spirit-Sight.

The magical powers of the Daemon of this letter are the attainment of higher forms of clairvoyance enabling visions from Sitra Achra, the power of cursing through the Evil Eye, the exposing of illusions and lies, the finding of hidden paths and treasures, the blinding of the enemy and the restoration of the sight of the blind, granting them a chance to find their ways out of the White Darkness that they have been confined to.

The following is the Seal of the Daemon of the letter Ayin:

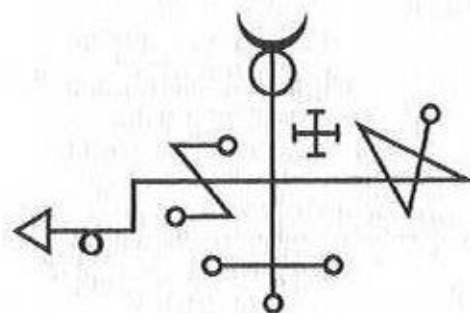

17 - פ Peh (Mouth) - 80 (value of final form: 800) - P - Mars
- Tower - Path 27

The Qliphoth of Peh is the Mouth of the Dragon of Thoughtless Light issuing forth the Alogos with the intention to destroy with Unworded Silence that which the Word has wrought and acts as the open hungry jaw that consumes finite life in order to re-establish via death the true deathlessness of the Divine Essence beyond the limitations of cosmic existence. It is the Mouth of Death itself breathing forth the Increase of Spirit from the shadow of Venus into the Venom-filled Cup held by the guardian of its gate within the Qlipha of the Poison of God, granting a curse and a blessing to those that would dare enter its path and climb its branch upon the Tree of Death.

The Peh of Sitra Achra swallows the Sun and brings light and life to the realm of death, by decreasing the power of its Sephirothic opposite thus sucking out the Light emitted into the lower personality by its reflected letter and aids the ascent instead of the descent of Spirit, serving the cause of Acosmic elevation and the returning of All back into Divine Nothingness.

The magical powers of the Daemon of this letter are the silencing of enemies and of one's own mind for the sake of martial victory or the attainment of liberating Gnosis, the receiving of magical formulae in unworded forms, the understanding of alien languages, the devouring of life-force of others and the Qliphothic transmutation of such consumed energies, the power to curse by words and to heal via exhaled smoke and breath.

The following is the Seal of the Daemon of the letter Peh:

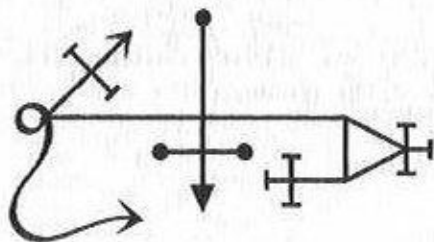

18 - ז Tzaddi (Fish-hook) - 90 (value of final form: 900)
- Tz - Aquarius - Star - Path 28

The Qliphoth of Tzaddi is the Fish-hook of the Deathly Fisher of the souls inhabiting the astral waters issuing towards and back from the Sea of Luna, snatching away the souls caught by its cosmic counterpart, not for the sake of their destruction but for their salvation from the spiritual descent that they are afflicted by in their drowning state causing their gravitation towards incarnation into the realm of matter beneath the Waters of the Moon. It is a power elevating the lower astral to its highest vibratory rate which brings its essence closer to formlessness, thus serving the cause of HVHY's Path of Ascent Through Reversal.

The Tzaddi of Sitra Achra is a letter that can realise its own power through Nun from Mem and thus elevate itself and that which it catches and constitutes together with those two letters a secret triad of Sacrifice, Death and Ascension bringing out and upwards the Divine Sparks trapped within the lower spaces of the Tehiru.

The magical powers of the Daemon of this letter are enticement, allure and domination, the exposure of falsity, the control over the actions of others, the attainment of knowledge from other people's dreaming minds, the recollection of that which has been forgotten, the entrapment of the Dark Dead and the returning of runaways.

The following is the Seal of the Daemon of the letter Tzaddi:

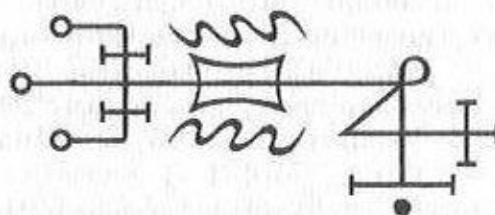

of leadership, wealth and worldly power without becoming attached to such finite constructs of deluded mind, the igniting of the solar power within those bearing the Light of the Other Side, Spiritual rebirth and initiation via the death of different aspects of the ego-construct and the dawning of the Black Sun of Thoughtless Self and enlightenment via the transcendence of the limitations of reason.

The following is the Seal of the Daemon of the letter Resh:

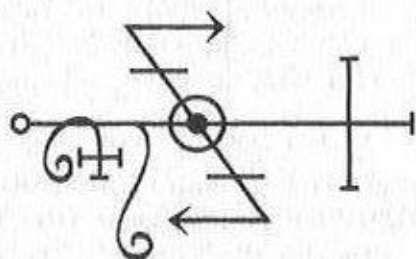

21 - ך Shin (Tooth) - 300 - Sh - Fire - Judgement - Path 31

The Qliphoth of Shin is the Teeth/Fangs of the Serpents of the Other Side, in manifested form depicting also both the Fiery Trident and the Triple Tongued Crown of Fire, also referred to as the Triple Tongued Flame of the Underworld, being a threefold manifestation of the primal Unmanifest Yod of the Thoughtless Divinity from Ain Sof in its most fiery manifestation, crowning, destroying and tearing apart depending on where, when and how its force is applied. The Shin of Sitra Achra is the Devouring Fire of the Spirit of HVHY taking form as the antithesis of the cosmic Mother Letter it reflects, acting as the dynamic force of anti-creation enlinked to the Qlipha of the Malkuth, via the Poisoner of God, being on both sides of the Tehiru the place where the three Mother letters descend to intermingle and give, in that fallen state, birth to the fourth element of earth.

The Shin of Sitra Achra is thus also the Chthonic Fire that if set loose will dissolve the material forms and return the elemental

essence back to its quintessential source being the fifth before the four and therefore the Zeroth, while its supernal place of championing the Return of ALL Back to the Fullness of Emptiness is as the Crown of Beelzebub within Aogiel.

The magical powers of the Daemon of this letter are purification by fire, the strengthening of the fires of the Other Side within those of the Serpent's Bloodline, the Evocation of Spirits, divination employing fire, the At-Azothic empowerments causing the shattering of finite forms, destruction of that which can not withstand the Fires of Thoughtlessness, the Spiritual elevation and fiery coronation gained through the gradual steps of alchemical initiation and finally Spirit Liberating Gnosis opening fully the gates of Acosmic Liberation.

The following is the Seal of the Daemon of the letter Shin:

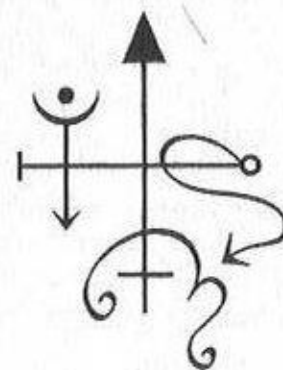

22 - ך Tav (Cross/Mark) - 400 - Th - Saturn - Universe - Path 32

The Qliphoth of Tav is the Mark, not as the mark set by the Angel of YHVH "upon the foreheads of the men that sigh and that cry for all the abominations that be done in the midst thereof" but instead one such as the Mark of Qayin's Exile exalting his Spirit by separating him from the cosmic order, leading him to walk the Path of Nod towards the Other Side.

It is also the letter of the Cross, depicted as such in its primal form of the Aleph-Beth, being in its Qliphothic aspect not the elemental cross of matter upon which the Spirit is nailed down but instead a Liminal Crossroads opening up the point in-between through which the Spirit may escape its intended crucifixion upon and within the Assiahic elements of the fallen world of matter.

The Tav of Sitra Achra opposes its cosmic counterpart by forming the branch lifting up the Spirit from the world of matter instead of being the path through which Spirit is made to fall into the crudest realm of form and manifestation, thus liberating it from its slavery and granting it sovereignty instead.

The magical powers of the Daemon of this letter are the opening up of the liminal points and gates such as the crossroads leading to the Other Side, the granting of Acosmic consciousness, the opening of the paths of liberation from binding weaknesses of both the physical body and its ego or any other form of material enslavement, the elevation of the souls and Spirit of the living and the dead, the granting of the power to transcend natural limitations, the destruction of both physical and spiritual enemies and consecration of all talismans and fetishes intended to keep within them any aspect of the astral light.

The following is the Seal of the Daemon of the letter Tav:

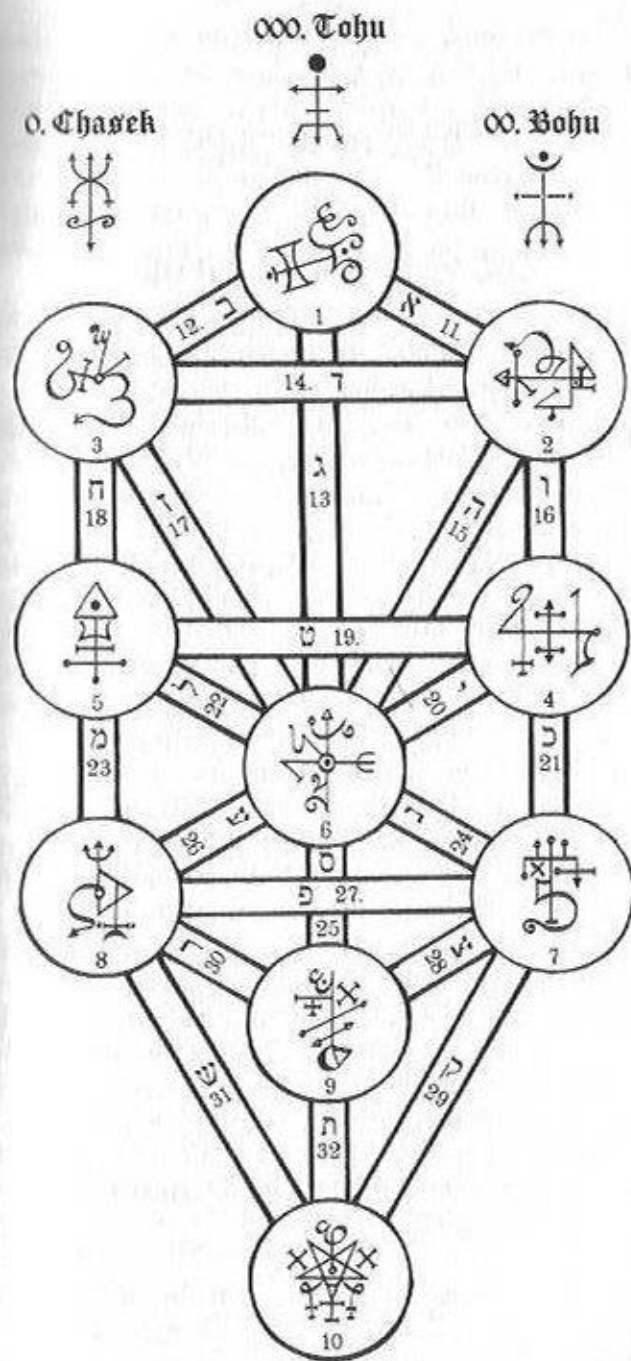
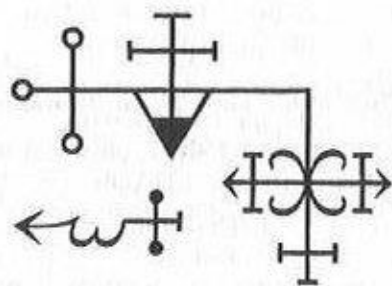



The 12 Princes of the Qliphothic Zodiac

The Princes of the Qliphothic Zodiac are the specific demonic emanations from the Twelve Simple Letters of the Alphabet of Sitra Achra manifested as the Antagonists of the 12 Tyrant Archons of Cosmic Fate who bind the Spirits imprisoned within the causal constructs of the Thoughtful Light with the Chains of Cruel Destiny and are as such the unfasteners of the fetters tying Divine Essence to limitation. The Princes of the Qliphothic Zodiac may primarily be called upon in accordance with one's own need to overcome and transcend the limitations of the personal horoscope by their disrupting and unfated alterations of the Web of Destiny, and secondly for the sake of the general magical empowerments they can offer to those serving their cause that can greatly aid in the thwarting of the limiting snares of fate upon the unlawful path leading towards the Other Side.

If called upon in order to dissolve the fetters of destiny imposed by their Sephirothic counterparts they are to be reached out to during the time best corresponding with their dominion which is the same time as when they clash with their mirrored opposites, but if called upon for the sake of any other general At-Azothic empowerment, or any other reason serving the cause of the Black Light, they can be evoked during the night and nocturnal planetary hour best corresponding to their own stations, underlying planetary force and routes of manifestation.

The modes of the operations intended to cause enlinkments to these forces are many and can take different forms depending on the intention and elevation of the work, but

besides the ceremonial approach aimed at the evocation of emanated aspects of these 12 Princes the next common and more practical approach is the fetishistic and talismanic one through which the golden chains of sympathy are established and the sought essences of these Sitrin Acharanin are enlinked to via suitable elements and forms in sympathy with their own essential causes.

For the simplest level of their evocation through and into graven images meant to serve as the Kelims which are to hold and be overflowed by the essences of these mighty deities of the Silencing Utterances of the Other God, one is to create the images in the correct time, inscribe upon it the corresponding seal, insert into it the stones and/or other elements in harmony with the zodiacal Qlipha it is meant to be in sympathy with, fumigate it with the suitable incense, sacrifice a fitting animal and colour it with its enlivening blood and finally place it upon the Point of Evocation and according to the ruling protocols of the Callings of the Sitrin Acharanin, the general modes of which will be outlined within the following chapters of this Grimoire, in order to cause desired enspiritment, manifestation and enlinkment. Such fetish of the Personal Zodiacal Qlipha is kept upon the altar reserved for the Workings of the Forces of the Thoughtless Cause and will greatly aid in the escape from predestined limitations of one's birth chart, when cultivated and worked properly. Similar steps can be taken in order to create smaller and more portable talismans and when such workings have culminated into the higher stages of the empowering forms of Spirit-Congress, lending the spiritual authority and licenses to continue and partake of the deeper mysteries, one can proceed to the stage of internalisation of the external manifestations via invocation, possession and inner alchemical manipulation, all according to and with the At-Azothic aid of the Qliphothic prince with whom at that stage the magician should have firm and mutually beneficial treaties. The following are the lists of correspondence disclosing enough to the Cunning Ones of the Serpent's Blood to allow them to connect themselves to these Liberating Deities of Acosmic Fate-Alteration and Sorcerous Might.

1. Da'atiron

Meaning of the name: The Flock

Letter of the Alphabet of Sitra Achra: 7 Heh

Sign of Zodiac: Aries

Time of Dominion: March 21 – April 20

Planetary Ruler: Mars

Element: Fire

Tarot Trump: Emperor

Incense: Dragon's Blood, Cinnamon powder, Galangal root powder, Aconite leaves, Rue and Tobacco

Animals: Ram, Horse, Mule, Leopard, Serpent

Stone: Bloodstone, Garnet, Ruby

Form assumed during astral manifestation: Ram-headed winged dragon-serpent, engulfed in black fire blazing up from within.

Sorcerous Attributes and Powers: Victory in Battle, overcoming of both physical and mental weaknesses, the imparting of leadership qualities and the granting of influence over others but also the power to diminish such qualities and influences when need be, the granting of courage or the installing of fear, the empowerment and focus of the powers of Will, the removal of the obstacles blocking the path leading to practical/materialistic goals, the sowing of discord amongst the ranks of the enemies, the consecration and empowerment of all magical weapons reserved for the workings of martial malediction and the aiding in all strategical planning connected to warfare and hostility.

Esoteric Seal of Da'atiron:

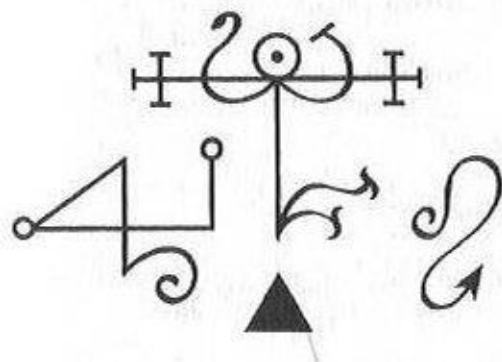

2. Abimiron

Meaning of the name: The Bloody Ones

Letter of the Alphabet of Sitra Achra: ʾVav

Sign of Zodiac: Taurus

Time of Dominion: April 21 – May 20

Planetary Ruler: Venus

Element: Earth

Tarot Trump: Hierophant

Incense: Apple wood powder, Storax, Patchouli, Musk, Blood Root, Elder leaves and Cardamom seeds

Animals: Bull, Calf, Swan, Swallow

Stone: Emerald, Jade, Lapis Lazuli

Form assumed during astral manifestation: Crowned Bull-headed dragon coloured red by the blood of his vanquished foes and the offerings he receives by his faithful, having his black glistening scales hidden beneath the scarlet covering.

Sorcerous Attributes and Powers: Pacification of hostile forces and/or inner weaknesses, strengthening of the wild aspects of the self and others, the causing of rage and bloodlust or the mollification of such emotions when need be, the power to attain freedom from captivity, the acquirement of wealth and rich harvest, the manipulation of the external illusions of reality in accordance to one's own beliefs and will, the controlling of the minds of the many, the disruption of static established traditions and beliefs giving way to unfated and new expressions and manifestations leading towards the Great Goal, and aid in all revolutionary plans meant to overthrow old authorities or limiting rules in order to further the cause of Lawless Becoming.

Esoteric Seal of Abimiron:

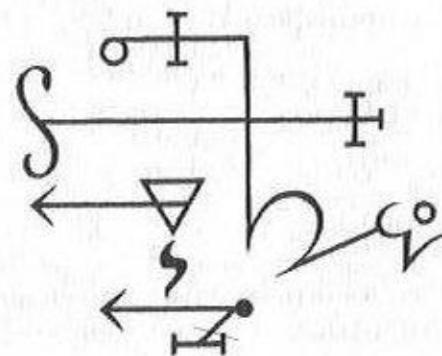

3. Tzalalimicon

Meaning of the name: The Clangers

Letter of the Alphabet of Sitra Achra: †Zayin

Sign of Zodiac: Gemini

Time of Dominion: May 21 – June 21

Planetary Ruler: Mercury

Element: Air

Tarot Trump: Lovers

Incense: Wormwood leaves, Mace (peels of Nutmeg), Mastic, Fly Agaric Mushroom powder and Fennel seeds

Animals: Magpie, Fox, Nightingale, Lark, Parrot

Stone: Agate, Aventurine

Form assumed during astral manifestation: Dual-headed winged dragon, wielding a flaming sword in each of its two hands, one burning with red and the other with black fires.

Sorcerous Attributes and Powers: The Causing of discord and disruption for the sake of the provocation of evolution through dynamic and often hostile dual tension, detachment from that which hinders progress towards the attainment of spiritual goals, cunningness and sharp and cold focusing of mental faculties, aid in escape from binding people or situations, initiations into the arts of occult medicine and poison, the power of beguiling through speech, love-witching and break-up work, and the attainment or union with specific aspects of the forces of the Other Side in order to strengthen the bonds of Serpent-Blood and Spirit.

Esoteric Seal of Tzalalimicon:

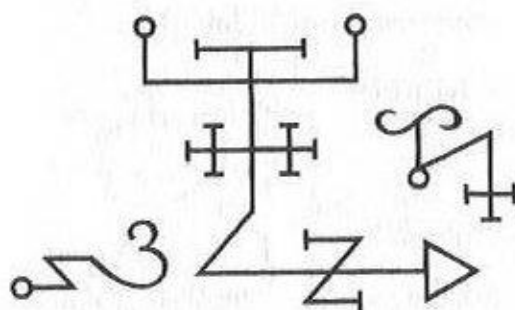

4. Shichiron

Meaning of the name: The Black Ones

Letter of the Alphabet of Sitra Achra: ן Cheth

Sign of Zodiac: Cancer

Time of Dominion: June 22 – July 22

Planetary Ruler: Moon

Element: Water

Tarot Trump: Chariot

Incense: Sandalwood powder, Lily flowers, Eucalyptus leaves, Willow leaves, Poppy seeds and Mugwort leaves

Animals: Crab, Turtle, Dog, Chameleon, Swine, Mice, Frog

Stone: Beryl, Moonstone, Sapphire, Clear quartz

Form assumed during astral manifestation: A pitch black Dragon of the Sea, without any clear visible features, a shadowless shadow of the Tananim, submersed in the Black Waters of the Qliphothic Moon.

Sorcerous Attributes and Powers: Sciomancy and other kinds of magic related to the reading, conjuring or otherwise controlling of the shades of both the living and the dead, the empowerment of all sorcerous workings of ligature, occult means for the manipulation of the emotions of others, the sharpening of one's intuition, attainment of invulnerability and victory in battle, wealth conjuring, the creation of energetic shields and barriers, the taming and subduing of the clay-born impulses of Adam, the opening of the mirror gates leading to the Other Side of the Tchiru and the ability to find or cause Liminal Points for the ingress and egress of Spirit.

Esoteric Seal of Shichiron:

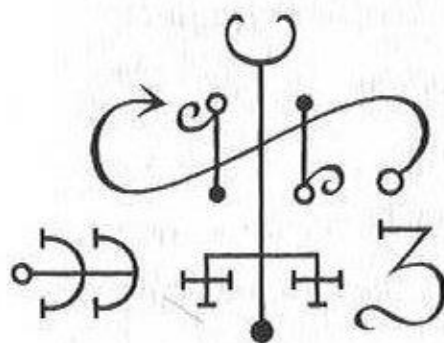

5. Shalehbiron

Meaning of the name: The Flaming Ones

Letter of the Alphabet of Sitra Achra: ♃ Teth

Sign of Zodiac: Leo

Time of Dominion: July 23 – August 22

Planetary Ruler: Sun

Element: Fire

Tarot Trump: Strength

Incense: Bay Laurel leaves, Frankincense resin, Turmeric, Saffron, Rosemary and Olive leaves

Animals: Lion, Wolf, Jackal, Crocodile, Boar, Bull, Eagle

Stone: Cat's eye, Amber, Carnelian, Diamond, Topaz

Form assumed during astral manifestation: A black dragon with the head of a furious majestic lion, coroneted with the Triple-Tongued Fiery Crown of the Black Light and armed with a golden sword.

Sorcerous Attributes and Powers: The granting of magnetic charm and charisma, the attainment of fame and admiration, the control and manipulation of the wills of others placing them under one's command, the illumination and empowerment through the Invincible Flames of the Black Sun, initiation into secret forms of pyromancy and other fire-related magic, attainment of control over one's self in order to transcend weaknesses, the granting of fearlessness when facing danger, the overpowering and dominating of foes, elevation to seats of power and the attainment of both temporal and spiritual autonomy.

Esoteric Seal of Shalehbiron:

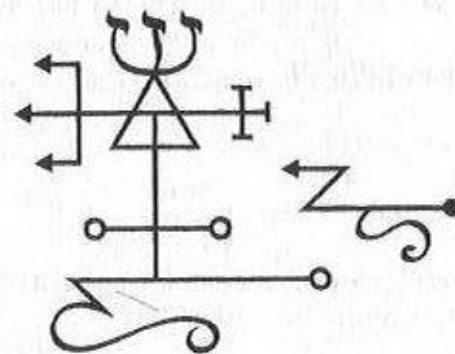

6. Tzaphieiron

Meaning of the name: The Scratchers

Letter of the Alphabet of Sitra Achra: ם Yod

Sign of Zodiac: Virgo

Time of Dominion: August 23 – September 22

Planetary Ruler: Mercury

Element: Earth

Tarot Trump: Hermit

Incense: Pomegranate peels, White Rose Petals, Orris Root, Dill seeds and Cedar wood powder

Animals: Cat, Weasel, Hart, Civet-Cat, Blackbird

Stone: Peridot, Agate, Aventurine

Form assumed during astral manifestation: A dragon with the head of a wrathful man crowned with a single flame of Black Fire, having the cloven tongue of a serpent and armed with claws sharp and long as deadly sickles.

Sorcerous Attributes and Powers: Transcendental meditation, attainment of insight concerning True Will and Divine Self, revelation of Inner Light by the penetration of outer darkness, communion with and control over the souls and spirits inhabiting the wild and desolate places, the power to heal or to spread malady, the liberation of the enslaved, the isolation and containment of any person, force or emanation, the granting of protection and concealment of self, deeds or others.

Esoteric Seal of Tzaphieiron:

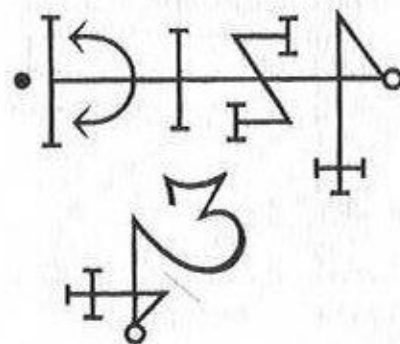

7. Al'abirion

Meaning of the name: The Clayish Ones

Letter of the Alphabet of Sitra Achra: 5 Lamed

Sign of Zodiac: Libra

Time of Dominion: September 23 – October 22

Planetary Ruler: Venus

Element: Air

Tarot Trump: Justice

Incense: Cherry tree resin, Galbanum, Lavender, Chamomile, Belladonna leaves and Coriander seeds

Animals: Pelican, Raven, Pigeon, Turtledove, Elephant, Spider

Stone: Chrysoprase, Turquoise

Form assumed during astral manifestation: A Giant with dragon-heads sprouting from each of his shoulders, robed with the flayed skins of man, dragging in each hand a plough behind him through a field of bleeding clay.

Sorcerous Attributes and Powers: The causing of imbalance and the breaking of the chains of stagnation, aid in successful transgression of laws, manipulation of judges and lawyers, granter of beauty and magnetic attraction, reinforcement of works of vengeance and punishment, protection of outlaws, the hindering of enemies and the turning of their attacks against themselves, the exposing of conspiracies, falsities and lies and the chaotic addition or subtraction of force in order to cause unfated becoming and the transcending of clay-born limitations.

Esoteric Seal of Al'abirion:

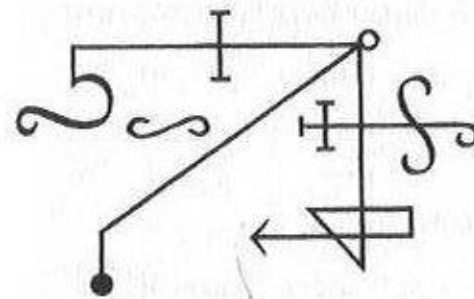

8. Necheshthiron

Meaning of the name: The Brassy Ones

Letter of the Alphabet of Sitra Achra: Nun

Sign of Zodiac: Scorpio

Time of Dominion: October 23 – November 21

Planetary Ruler: Mars

Element: Water

Tarot Trump: Death

Incense: Ginger Powder, Opoponax, Tobacco, Thorn Apple and Sulphur

Animals: Beetle, Wolf, Scorpion, Ass, Hawk, Crow

Stone: Snakestone, Kunzite, Spinel, Tourmalated Quartz

Form assumed during astral manifestation: A Brazen Dragon with the stinging tail of a scorpion, armed with a reddened scythe and crowned with a Black Sun illuminating him from behind.

Sorcerous Attributes and Powers: Maledictions afflicting both body and soul, the summoning of the violent dead to attack enemies, attainment of insights into the mysteries of sinistral death, the opening of the watery gates of the dead intersecting with the Seas of the Nun of Sitra Achra, the safeguarding or revealing of secrets, the aiding of spiritual evolution by ruthlessly killing that which hinders it, aid in all work of soul-smiting malediction, granting of liberation through violence and upheaval and aid in unfated transformations meant to transfer the Spirit to the Side of the Dragons of Qliphoth.

Esoteric Seal of Necheshthiron:

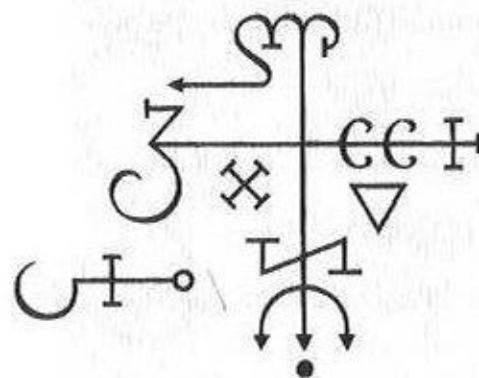

9. Necheshiron

Meaning of the name: The Serpentine Ones

Letter of the Alphabet of Sitra Achra: Samek

Sign of Zodiac: Sagittarius

Time of Dominion: November 22 - December 21

Planetary Ruler: Jupiter

Element: Fire

Tarot Trump: Temperance

Incense: Black Copal, Cedar wood, Juniper, Henbane and Sumac

Animals: Snake, Horse, Dog, Deer, Pheasant

Stone: Jacinth, Amethyst, Sugilite

Form assumed during astral manifestation: A black winged and horned Serpent, surrounded by a circle of broken arrows, which he burns with the Black Fire emitting from his open jaws.

Sorcerous Attributes and Powers: The power to turn impending defeat into victory, the confusing and misleading of one's accusers, aid in escape from prison or enemies, discovery of hidden treasures and attainment of riches (both material and spiritual), the causing of fertility and virility or bareness and impotence, aid in lycanthropic transformations and alchemical transmutations, the taming of the Night-Mare, the arousing of the Serpent Fire within and the attainment of metaphysical insights concerning the Holy Gifts of the Nachash and the esoteric means through which they can be attained and realised.

Esoteric Seal of Necheshiron:

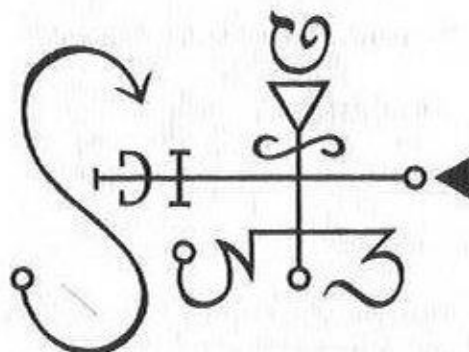

10. Dagdagiron

Meaning of the name: The Fishy Ones

Letter of the Alphabet of Sitra Achra: V' Ayin

Sign of Zodiac: Capricorn

Time of Dominion: December 22 – January 19

Planetary Ruler: Saturn

Element: Earth

Tarot Trump: Devil

Incense: Pine, Salep root, Mandrake root, Valerian root, Patchouli, and Wormwood

Animals: Goat, Ass, Toad, Snake, Hare, Bat

Stone: Coal, Apache Tear, Hematite, Onyx

Form assumed during astral manifestation: A goat-headed dragon of the seas of chaos, bearing the imperishable and brilliant Dual Flame of Black Light between his horns, swimming through the crashing waves of the Great Deep.

Sorcerous Attributes and Powers: The traversing of the Sea of the Dead connected to the Nahemothic realm, initiations into the antinomian and liberating mysteries of the Other Sabbath, the empowerment of all witchcrafts related to the Seirim and their Master beneath the Mountain of Darkness, initiation into the mysteries of the Crown of Fire and the Black Halo of the Sainly Ones, the workings of malediction related to the Evil Eye, the empowering of all evocations of the forces of the Other Side, the transcending of the Gates of Matter by the correct entering of the Devil's Reversed Path of Spirit as expressed through the HVHY and the ability to banish material obsessions via the Black Banquet of Detaching Indulgence.

Esoteric Seal of Dagdagiron:

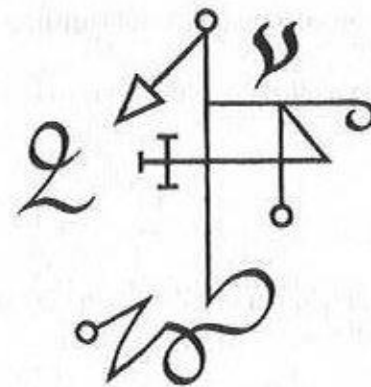

11. Bahimiron

Meaning of the name: The Bestial Ones

Letter of the Alphabet of Sitra Achra: ז Tzaddi

Sign of Zodiac: Aquarius

Time of Dominion: January 20 – February 17

Planetary Ruler: Saturn

Element: Air

Tarot Trump: Star

Incense: Galbanum, Myrrh, Colophony, Angel's Trumpet flowers, Palo Santo and Verbena

Animals: Man, Eagle, Peacock, Camel, Mole

Stone: Chalcedony, Aquamarine, Fossils, Jet

Form assumed during astral manifestation: A titanic black juggernaut resembling in form that of a hybrid between a mammoth and a hippopotamus, but scaled like a dragon, crushing all that stands in his way.

Sorcerous Attributes and Powers: The strengthening of the powers manifesting one's True Will, the attainment of inner power and control over emotions, regeneration of life-force via occult means, initiations into the deeper mysteries of the Eleven and how Liberating Thoughtlessness can be attained through its/their different essential manifestations, the forceful crushing of internal and external enemies via the correct direction of power towards their points of weakness, the opening of new channels for the Kelim-Shattering Waters of the Tehomoth ha-Sitra Achra and the revealing of new ways through which the forces of the Other Side can be invoked and internalised for the sake of At-Azothic empowerment and ascension.

Esoteric Seal of Bahimiron:

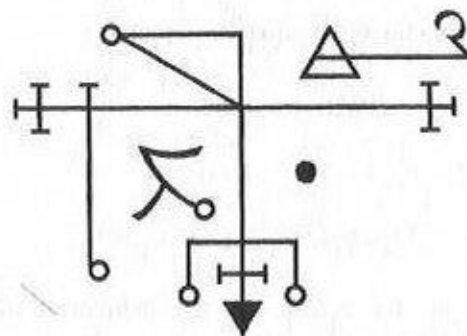

12. Nashimiron

Meaning of the name: The Malignant Woman

Letter of the Alphabet of Sitra Achra: Qoph

Sign of Zodiac: Pisces

Time of Dominion: February 18 – March 19

Planetary Ruler: Jupiter

Element: Water

Tarot Trump: Moon

Incense: Fig leaves, Calamus root, Clove, Black Hellebore root and Hyssop

Animals: Fish, Shark, Screech-owl, Snake, Wolf

Stone: Pearl, Amethyst, Lepidolite

Form assumed during astral manifestation: A draconic siren, having the lower body of an aquatic Dragon-Serpent and the upper body of a beautiful woman with long dark hair, red lips and radiant black mesmerising eyes.

Sorcerous Attributes and Powers: Astral projection and the opening of the Oneiric Gates leading to the Other Side, the sending of nightmares and the art of dream-intrusion, energetic vampirism and channelling and manipulation of life-force, acquisition of esoteric knowledge and initiation into lycanthropic arts of shade-shifting, the granting of Night-Sight, initiation into the secret forms of hydromancy, the exposing of hidden dangers and enemies, the empowerment of one's intuition and mediumistic skills, the causing of madness and the casting of the enchantments of glamour and illusion or the banishing of such deception.

Esoteric Seal of Nashimiron:

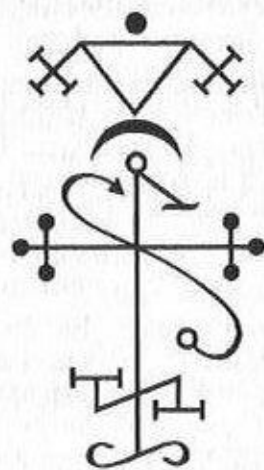



The Seven Hells and Seven Earths

Within the Sitra Achra are the Seven Places holding within them the Ten Qliphoth governed by the Eleven Heads of Azerate. These Seven Places, or more correctly Kingdoms, are called the Seven Hells by those that would consider the Qliphoth as the hellish realms, but in reality these Kingdoms of Thoughtlessness are far removed from anything related to the places of punishment that they by the Adamites are feared to be, because these realms of Sitra Achra are outside of the jurisdiction of the cosmic creator and as such do not serve his will to inflict torment.

When the actual reality and nature of this and the Other Side is realised according to the Current that our Book of Sitra Achra presents it becomes clear that the places of punishment to which the YHVH can condemn those that would offend him are in this accursed Sephirothic side of the Tehiru and not on the Other Side, as he holds no dominion over the Realm of the Thoughtless God and even if he can banish and expel Spirits to That Side he can not dictate their conditions within that realm as it is fully outside of the reach of his binding law and limiting will.

The places of punishment to which the YHVH does condemn his creation must as such be understood to be located within his own Structure of Thought and Form and under his own causal dominion and are according to Tradition and older lore believed to be within the Seven Earths of the Sephiroth and not at all within what is called the Seven Hells of Qliphoth.

There are a few different variations and differences in the

attributed names and the exact order of succession of the Seven Earths and the Seven Hells depending on the textual sources. A very relevant example is the following description of the Seven Earths quoted from the book 'The Legends of the Jews' by Louis Ginzberg concerning the Inhabitants of the Seven Earths:

"When Adam was cast out of Paradise, he first reached the lowest of the seven earths, the Erez, which is dark, without a ray of light, and utterly void. Adam was terrified, particularly by the flames of the ever-turning sword, which is on this earth.

After he had done penance, God led him to the second earth, the Adamah, where there is light reflected from its own sky and from its phantom-like stars and constellations. Here dwell the phantom-like beings that issued from the union of Adam with the spirits.

They are always sad; the emotion of joy is not known to them. They leave their own earth and repair to the one inhabited by men, where they are changed into evil spirits. Then they return to their abode for good, repent of their wicked deeds, and till the ground, which, however, bears neither wheat nor any other of the seven species.

In this Adamah, Cain, Abel, and Seth were born. After the murder of Abel, Cain was sent back to the Erez, where he was frightened into repentance by its darkness and by the flames of the ever-turning sword. Accepting his penitence, God permitted him to ascend to the third earth, the Arka, which receives some light from the sun.

The Arka was surrendered to the Cainites forever, as their perpetual domain. They till the ground, and plant trees, but they have neither wheat nor any other of the seven species.

Some of the Cainites are giants, some of them are dwarfs. They have two heads, wherefore they can never arrive at a decision; they are always at loggerheads with themselves. It may happen that they are pious now, only to be inclined to do evil the next moment.

In the Ge, the fourth earth, live the generation of the Tower of Babel and their descendants. God banished them thither because the fourth earth is not far from Gehenna, and therefore close to the flaming fire. The inhabitants of the Ge are skilful in all arts, and accomplished in all departments of science and knowledge, and their abode overflows with wealth. When an inhabitant of our earth visits them, they give him the most precious thing in their possession, but then they lead him to the Neshiah, the fifth earth, where he becomes oblivious of his origin and his home.

The Neshiah is inhabited by dwarfs without noses; they breathe through two holes instead. They have no memory; once a thing has happened, they forget it completely, whence their earth is called Neshiah, "forgetting."

The fourth and fifth earths are like the Arka; they have trees, but neither wheat nor any other of the seven species.

The sixth earth, the Ziah, is inhabited by handsome men, who are the owners of abundant wealth, and live in palatial residences, but they lack water, as the name of their territory, Ziah, "drought," indicates. Hence vegetation is sparse with them, and their tree culture meets with indifferent success. They hasten to any water spring that is discovered, and sometimes they succeed in slipping through it up to our earth, where they satisfy their sharp appetite for the food eaten by the inhabitants of our earth. For the rest, they are men of steadfast faith, more than any other class of mankind.

Adam remained in the Adamah until after the birth of Seth. Then, passing the third earth, the Arka, the abiding place of the Cainites, and the next three earths as well, the Ge, the Neshiah, and the Ziah, God transported him to the Tebel, the seventh earth, the earth inhabited by men."

According to the quoted narrative the names and order of succession of the Seven Earths should be as following:

1. Erez (Dry Earth)
2. Adamah (Red Clay)
3. Arka (Earth)
4. Ge (Vally)
5. Neshiah (Oblivion)
6. Ziah (Dryness/Desert)
7. Tebel (Firm Land/the World)

While the names and descriptions of the earths given are of great relevance and interest, their order of succession in the way that they are superimposed upon each other are in conflict with other more common descriptions of these same sevenfold layering of the earths, which instead of the above given description places them in the following manner that also connects them to the Sephiroth, for which they constitute as the Seven Habitations of the Ten:

1. Eretz – the Three Supernal Sephiroth
2. Adamah – Chesed
3. Ge – Geburah
4. Nashiya – Tiphareth
5. Ziah – Netzach
6. Arka – Hod
7. Tebel – Yesod and Malkuth

The placement of the Enduring Souls of the Qayinite within Arka, the earth corresponding with Hod, is of interest as according to Esoteric Tradition the Transcendent Spirits of the Qayinite are located in the Qlipha of Netzach, which is something that if understood properly discloses aspects of the true nature of the antithetical polarity that exists between the Sephiroth and the Qliphoth and their effects upon the Souls and the Spirits.

When it comes to the Seven Qliphothic Kingdoms or Hells there are also inconsistencies within the different sources when

it comes to the exact order of succession and even their naming and as these realms are named by the worshippers of YHVH the meanings are of course prejudicial and accusative in a way meant to paint a hellish vision of the Other Side in order to act as the glorifying counterpart to their own illusory and false ideas concerning the paradisaical place below the feet of their creator, thus gilding the cage that keeps them enslaved within the deluded and spiritually diluting mind and thoughts of that Demiurge.

Similarly to how the prejudicial names of the Qliphoth have within certain esoteric contexts become revalued and recharged in essence and connected to the actual Light and Essence of the Other Side and so elevated from the lowly concepts that they were by the profane meant to represent so have also the names given to the Seven Hells become essentially rectified and connected to Currents far above and beyond that which they were meant to originally represent and are within the correct context now most powerful and lofty points of focus for those that serve the Alien El of Thoughtlessness.

The following are the names of the Seven Qliphothic Kingdoms of the Eleven and their way of succession from the highest to the lowest sphere, as accepted and assimilated by the Thoughtless Current of Anti-Creation manifested through the Tradition upholding the teachings presented within this book of those that strive to champion the Cause of the Other Side:

1. Sheol ha-Tehom – Grave/Hollow of the Abyss – the Supernal triad of Qliphoth
2. Abaddon – Destruction – Gash Khalah
3. Tit ha-Yon – Mire of Mud – Golachab
4. Bar Shachath – Pit of Ruin – Thagirion
5. Tzelmoth – Shadow of Death – Oreb Zaraq
6. Shaarimoth – Gate of Death – Samael
7. Gehinnom – Valley of Hinnom – Nahemoth and Gamaliel

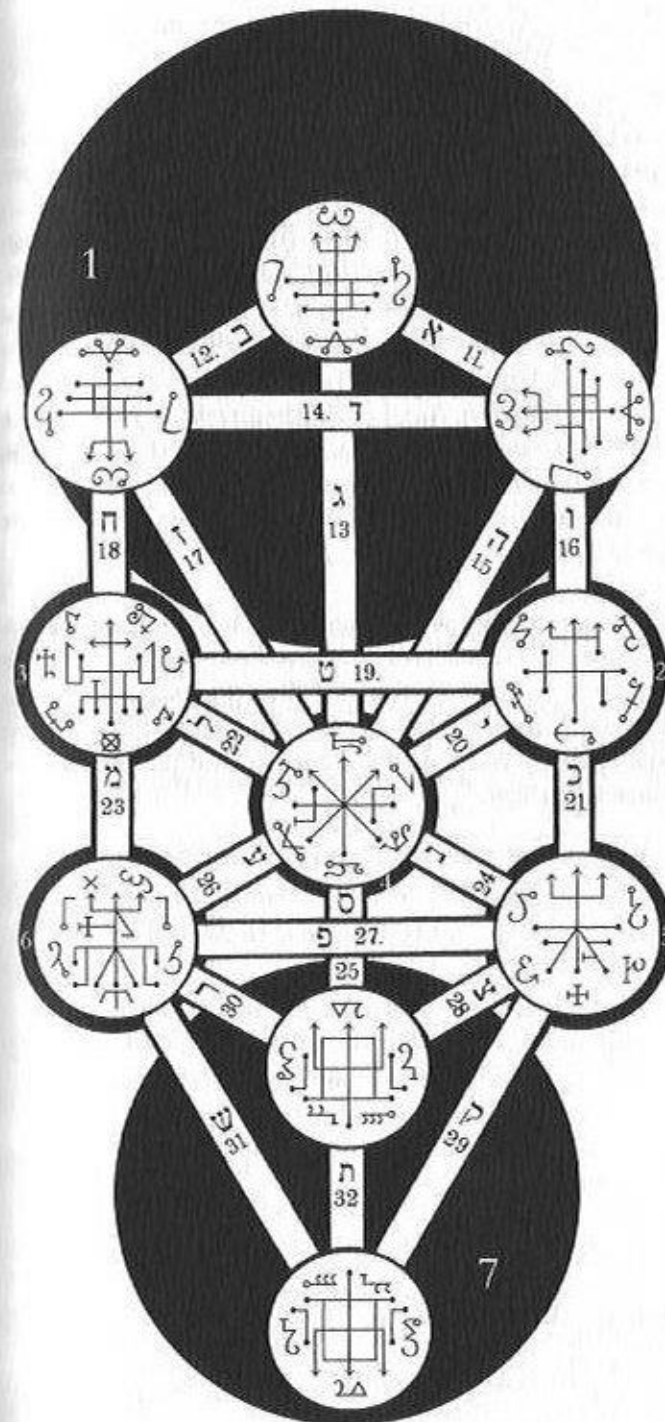

1. Sheol ha-Tehom

Sheol ha-Tehom, exoterically just called Sheol and more esoterically by our Tradition named as the Tehom, is from the Sephirothic perspective the deepest part of the Abyss of Qliphoth and constitutes of the three first supernal Qliphoth of Thaumiel, Aogiel and Satariel, headed by ha-Satan, Molok, Beelzebub and Lucifuge Rofocale. Sheol ha-Tehom, the Grave of the Great Deep/Abyss is the habitation or Kingdom closest to the transcendent aspects of the Tohu, Bohu and Chasek linked to Ain and is the manifestation of the Unmanifest, balancing upon the edge of anti-existence, coming into being only for the sake of the Return of All to and the restoration of the Fullness of Primordial Divine Nothingness.

From the initiatory perspective this First Kingdom or Hell is the Seventh Gate to enter, as from the position of those climbing the Tree of Death this Kingdom of the Dragon is entered through the last gate, represented by the following Seal of the Seventh Gate of Hell, also called the Gate Seal of Sheol ha-Tehom:

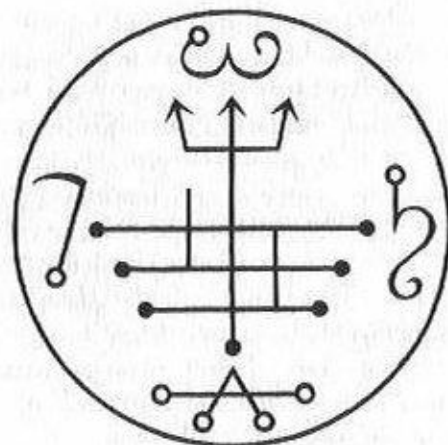

Sheol ha-Tehom's Threefold Opening Formula:

*Athiel ✱ Lucifuge Rofocale ✱ Satariel ✱ Sathamel ✱ Ayomel ✱
Taalummabel ✱ Aphelabel ✱ Radabel ✱ Irahtzel ✱ Ashmanel ✱
Laatel ✱ Liftoach Shaari ha-Sheol ha-Tehom!*

*Beliel ✱ Beelzebub ✱ Aogiel ✱ Abedabel ✱ Okuroel ✱
Gebel ✱ Iashamel ✱ Acharel ✱ Laabel ✱
Liftoach Shaari ha-Sheol ha-Tehom!*

*Qemetiel ✱ Satan ✱ Molok ✱ Thaumiel ✱ Thaninel ✱ Akzarel ✱
Uazarel ✱ Mibdalabel ✱ Ianabel ✱ Abadel ✱ Labbabel ✱
Liftoach Shaari ha-Sheol ha-Tehom!*

2. Abaddon

Abaddon, the Destroyer or the Hell of Destruction, is the Kingdom of the Gash Khalah being that of the Qlipha of the Shakers to Complete Destruction governed by Astaroth and is the Point of Thoughtlessness on the Other Side annihilating the primary root of the manifestations emanating from the Sephirothic Atziluth while instead manifesting and focusing the impulses of the Qliphothic aspect of that first supernal world within the Briahic level in order to destroy the creation of its Thoughtful counterpart by replacing its 'thoughts of creation' with those of Thoughtless Annihilation, leading the Spirit entering this mental point of rectification through destruction closer to the attainment of the Highest Crown of Nihilicity beyond all cosmic restrictions.

From the initiatory perspective this second Hell of Qliphoth is entered via the Sixth Gate through which the Thoughtless Adept must enter in order to reach for the Crown of the Dragons of the Other Side. The following is the Seal of the Sixth Gate of Hell, also called the Gate Seal of Abaddon and its corresponding Opening Formula:

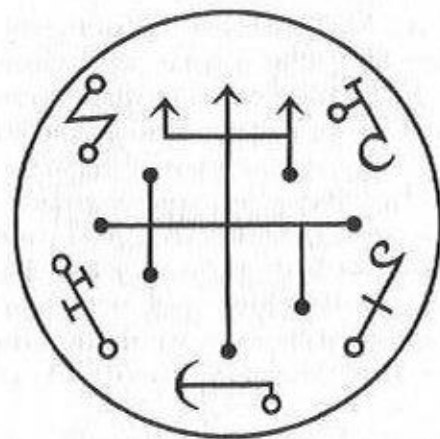

Abaddon's Opening Formula:

*Astaroth ✱ Gash Khalah ✱ Gadael ✱ Akalel ✱ Sharavel ✱
Kaphabel ✱ Lachamel ✱ Haragel ✱
Liftoach Shaari ba-Abaddon!*

3. Tit ha-Yon

Tit ha-Yon, the Mire of Mud also less commonly translated as the Boiling Mire, is the Kingdom of the Golachab being that of the Qlipha of the Flaming Ones and the Burners with Fire, governed by the wrathful Asmoday and is a Point of Holocaust spelling death to any remnants of the clay-born limitations which within this stage become melted off the Imperishable Bones of Spirit so that one may embark upon the next following levels of cleansing and restoration of Nothingness in a purified and empowered manner, leaving behind the melted corpse of Adam and instead rising up as a Flame approaching the Highest Thrones of Acosmic Fire.

From the initiatory perspective this third Hell of Qliphoth is entered via the Fifth Gate through which the Seed of the Serpent is further cleansed in its preparation for the return back into and germination within the womb of Tehom. The following is the Seal of the Fifth Gate of Hell, also called the Gate Seal of Tit ha-Yon and its corresponding Opening Formula:

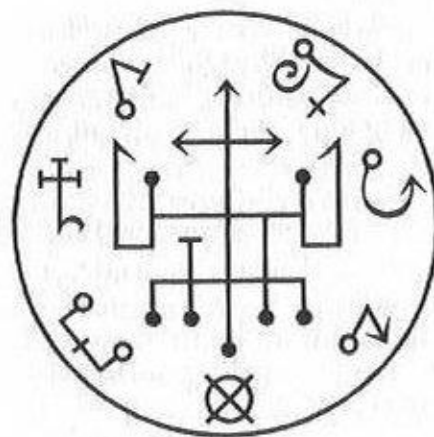

Tit ha-Yon's Opening Formula:

*Asmoday * Golachab * Gophriythel * Ophiseshel *
Labatel * Charchurel * Balael *
Liftoach Shaari ha-Tit ha-Yon!*

4. Bar Shachath

Bar Shachath, the Pit of Ruin, originally referring to a Ditch for the Rotting Away and Corruption of the (cast off) Material Corpus, and is the Kingdom of Thagirion being that of the Disputers and Opponents of the Thoughtful Law and governed by the Lawlessness of Belfegor and is a Point of the Unfated Resurrection of the Crowned Dead and a rising Pillar of the Beast of the Final Revelation, granting Life in Death and Flaming Wings to those that wilfully let their clay-born aspects rot under the heat of the Black Sun, in order to become illuminated by its light and move further into the Cleansing Fires of Thoughtless Restoration of Spirit upon the Serpentine Path of the Eleven-Headed El.

From the initiatory perspective this fourth Hell of Qliphoth is entered via the Fourth Gate through which the Dawn of the Resurrection of the Dead that have crossed the Sea of Death is achieved by the transformation of the Raven into the Phoenix. The following is the Seal of the Fourth Gate of Hell, also called the Seal Gate of Bar Shachath and its corresponding Opening Formula:

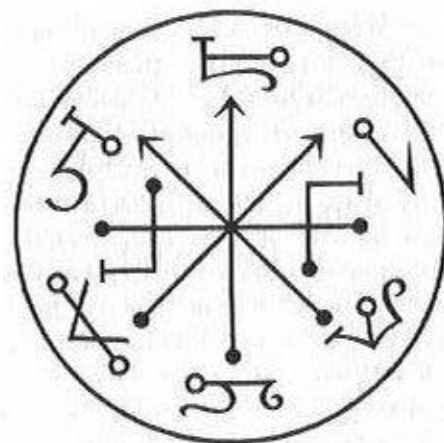

Bar Shachath's Opening Formula:

*Belfegor * Thagirion * Towebabel * Gaoznel *
Ramamel * Iqedael * Rababel * Oriensel * Natashel *
Liftoach Shaari ha-Bar Shachath!*

5. Tzelmoth

Tzelmoth, the Shadow of Death, often placed by others in the position of the sixth hell is within our tradition not a shadow encountered before entering the Gates of Death but instead a shadow first experienced and assumed after having passed through that Gate of Samael and arrived to the next Kingdom/Hell where the Throne of the Shadow of Death is suited, esoterically understood as being a foreshadowing of the deathlike aspect of the Qliphothic Letter of Nun, caused and cast by the light it receives from the Black Sun and manifested within the Qlipha of the Ravens of Death, where those Ravens of Scattering become as embodiments of that Deathly Shadow, giving wings to those Ascended Ones of the Serpent's Seed that can take to the Flight of No Return, for the sake of the Liberation of Soul and Spirit from the imprisonment that otherwise would have been caused through Thoughtful Rebirth.

From the initiatory perspective this fifth Hell of Qliphoth is entered via the Third Gate through which the Liberation granted by Unfated Death sets free the Souls and Spirits scattering forth, leaving behind the corpse of their Abel slain upon the Akeldama to feed the Gulgaltha. The following is the seal of the Third Gate of Hell, also called the Seal Gate of Tzelmoth and its corresponding Opening Formula:

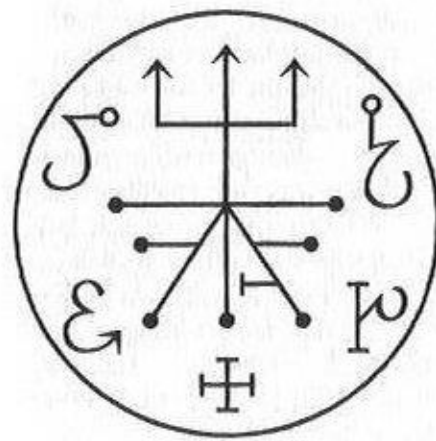

Tzelmoth's Opening Formula:

*Bualtzelmoth * Oreb Zaraq * Ongirtael * Ratsachel *
Bazarel * Zabachel * Rabel * Qeberel *
Liftoach Shaari ha-Tzelmoth!*

6. Shaarimoth

Shaarimoth, the Gate of Death, placed here in its, for our Current and Tradition, the proper position in relation to the alchemical process connected to the intake of the Venom of the Serpent alchemically transmuted into the Poison of God, bringing about the death of that which binds the Self to the El of Sephiroth while at the same time empowering the enlinkments to the El of the Thoughtless Side, turning the keys of the Gate of Adramelek by the wilful acceptance of the death of the finite forms for the sake of the attainment of the infinite essence gravitated to by the Qliphoth and is a point of sacrifice of the limited ego and mind, opening up the possibility for unfated expansion, transcendence and rebirth outside of the Sephirothic Tehiru.

From the initiatory perspective this Sixth Hell is entered via the Second Gate, through which the Adamite ego bitten by the Taninsam is in dying condition allowing the emerging Spiritual Self to here become led to the altar of the Peacock King for the sake of the attainment of the Poison-Antidote Elixir yielded by the Peacock-King to those that he would find of worth, causing by the demise it induces to the limiting aspects the separation of the ego born of clay, from the Self born from the sparks of the Fires of the Black Light, this by allowing entrance to and through the Gate of Death and by the granting of the purification that such initiatic death entails. The following is the Seal of the Second Gate of Hell, also called the Seal Gate of Shaarimoth and its corresponding Opening Formula:

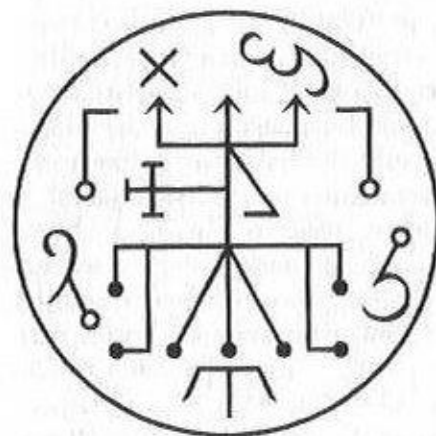

Shaarimoth's Opening Formula:

*Adramelek * Samael * Salaphel * Maradel * Ayabel *
Lachatsel * Liftoach Shaari ha-Maveth!*

7. Gehinnom

Gehinnom, the Valley of Hinnom, believed to originally be the name referring to a valley on the south side of Jerusalem where the worshippers of Baal and Molok let their children pass through the fire as sacrifices to the Elohim Acherim, and as such deeds were considered to have cursed the valley in question it came to be a place considered as a physical gate to Hell and is said to later have been used as a place reserved for the burning of all kinds of unclean waste, such as the carcasses of impure animals and the corpses of criminals. While none of these claims have been proven to be historically authentic the symbolism related to this valley has been employed in order to also name the seventh and the lowest hell, encompassing not one but two Qliphoth, namely Gamaliel and Nahemoth, being the lunar and sub-lunar Qliphoth intersecting the closest of all the other Light Filled Shells of the Other Side with the Sephirothic side of the Tehiru. Gehinnom is as such a Divided Kingdom, being on the lower half under the Throne of Na-Ama-Hema (Naamah-Nahemah) and on the upper half under the Throne of Ama Lilith, showing thus a clear enlinkment between the workings of Nahemoth and Gamaliel, as by the Bloodline of the Serpent linked from this side to the Other Side the Gates of Gehinnom can first be opened and entered into and from there and via the fivefold empowerment that can be gained from the Five Blessed Nations one can ascend to the Lunar Point, where the Mother of Sitra Achra will grant her Envenomed Nectar of Awakening to those worthy ones that willingly accept the Bite of the Serpent, in order to carry that Poison Within to the Peacock King of the Gates of Death and there fully attain its refined effect for the sake of the Opening of the Eye Through the Death of the I. From the initiatory perspective this Seventh Hell is entered via the First Gate through which the actual Qliphothic Work is initiated and the points of ingress and egress for the Serpents opened in order to aid in the Kelim Shattering intrusion of the Light of the Thoughtless Side, making possible also one's escape from this accursed side of the Tehiru. The following is the Seal of the First Gate of Hell, also called the Seal Gate of Gehinnom and its corresponding Opening Formula:

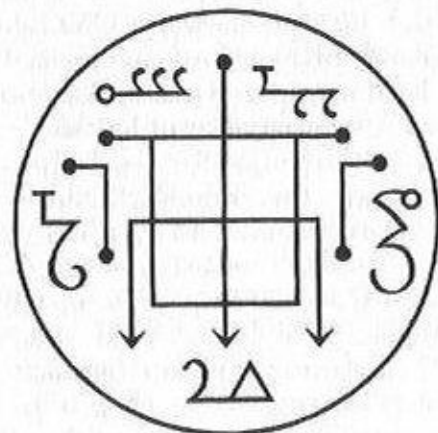

Gehinnom's Twofold Opening Formula:

*Ama Lilith * Gamaliel * Gadaphel * Maarabel *
Lachasbel * Iatsathel * Avvabel * Layilel *
Liftoach Shaari ha-Gehinnom!*

*Naamah * Nahemah * Na-Ama-Hemah * Nabemoth *
Neqamabel * Hamabel * Mirshaathel * Atadel *
Thazazel * Liftoach Shaari ha-Gehinnom!*

The Seals of the Gates of Hell, and their general Opening Formulae provided, have a multitude of practical uses within the context of Spiritual and Magical Work and can be employed in many different ways depending on the context. When employed in the forms presented they are used as physical point of focus that can create liminality between this and the part of the Other Side that they lead to, opening up both a gate and pathway, or bridge, that can lead to and from their place of activation.

Each of the Seal Gates have seven visible points of power, in similarity to many other Qliphothic seals and those seven points are all interlinked and in essence connected through the Eleven Heads Governing the whole of the sevenfold Manifestation of their *Reshut ha-Rabbim* (Realm of Multiplicity).

These points can be understood as the seven keyholes to each of the locked gates, but also the connecting points between all the Seven Kingdoms through which all the Qliphothic forces owning enlinkments to and through them can move and manifest freely and unrestricted, intruding through such Points of Manifestation wherever their power needs to cause effect, bless or afflict.

The practical applications of these seals are legion and not possible to fully disclose here, as the insight concerning their more concealed modes of employment and activation is also something reserved for those that can commune with the Sitrin Aharanin and through them gain direct initiation into such fundamental mysteries reserved solely for the Brood of the Serpents caught within this accursed side of the Tehiru, but we can still in this and the following chapter vaguely point to some of the more obvious areas and modes of utilisation of these most powerful Points of Qliphothic Ingress and Intrusion in order to further and aid in the Work of the Good Brethren of the Bloodline of Nachashel.

When the forces of the Qliphoth are to be evoked via one of

these Gates of the Seven Kingdoms of Qliphoth it is stated by Tradition that the form is to be marked with the freshly spilt blood of a fitting sacrifice (that of the venomous snakes being generally the most suitable, powerful and holy offering, if given in the worshipful and correct manner), sympathetically connected to the realm to which one seeks to open up a gateway towards. The Gate Seal itself is to be marked within the heart of a Hendecagram corresponding to the desired direction of power and level of manifestation. The points of the Hendecagram are to be given the flames of eleven black candles while the seven points of the Gate Seal are to be given the flames of seven upper half red and lower half black candles. This in combination with correct fumigation and employment of Intoned Opening Formulae and the quickening of all inner enlinkments possessed will turn the Seven Keys and Open the Gate.

Within other contexts these seals can be employed in connection to the creation of some of the many Mirror Gates that can be used for the gaining of access to both visions and flows of the energetic currents and illuminating light emitting from the Other Side. This can be done in several ways, but most often a black mirror is created, with the glass and its frame being in an angular and not round shape, in its optimal form having been cut in the shape of a hendecagon and placed within a suitable black wooden frame that must have a removable back. The seal in question is within such Work marked upon a fitting piece of parchment or consecrated paper with the aforementioned spilt blood and surrounded by the other seals pertaining to the Kingdom that the mirror is to act as a window towards. The seals of the Head/s of Azerate ruling the Kingdom are to be placed above the Hell Gate Seal, while the seal of the primary Qlipha, or as in the case of the first and last Kingdom the Qliphoth (being plural), on the left side and the seals of the Emissaries of the Qlipha (or Qliphoth) are to be marked below the central Hell Gate Seal and finally upon the right side of the parchment or paper the magical and true name, or the seal representing it, of the one who seeks to employ the Mirror Gate is to be written or drawn.

This blood-written talisman of the Hell Gate, its Ruler/s, Qlipha/Qliphoth and Emissaries are then placed within the frame of the black mirror, facing the back of the blackened glass and with the back of the frame reattached and temporary sealed, with the possibility to be reopened when and if other specific elements or seals of specific powers or targets are to be added inside the back of the mirror in order to cause further specific enlinkments or empowerments. The Mirror is then placed upon the corresponding Gate Seal at the centre of a Hendecagram of the suitable variety acting as an astral gate towards the Sitra Achra in a manner that leaves room for the activation of the Hell Gate Seal, often positioning the mirror upon or close to the threefold points of its direction of the flow of power (i.e. the three arrow points found within each seal representing the movement of the Current from and back towards the Three Dark Veils Above and Before the Qliphoth).

The Gate is then opened in traditional manner and the Black Mirror consecrated and fully enlinked on all levels to the Other Side. When the Work is done and all candles have been left to burn down fully the mirror is wrapped in black silk and kept upon the altar and unveiled only when it is to be used within the context of scrying, the receiving and sending of visions, invocation and certain forms of Evocation.

The most effective employment and use of such Black Mirror Gate is often accomplished with the mirror correctly placed upon a corresponding and opened Gate Seal, within this context without the employment of a surrounding Hendecagram, positioned in such a way that the seven candles are behind and not before the glass of the mirror, making it necessary in all cases, except when the Gehinnom Mirror Gate and Seal is employed, to stand on the topmost side of the seal with the back of the mirror towards the seven Points of Power and the flames burning upon them, placing thus also the operator in the way of the directing points of the seal during such workings.

When it comes to the talismanic applications of the Hell Gate seals there are many, but most useful and important is the adornment of the Lamén or Talisman of Evocation, which the operator should carry around the neck during the rites intended to cause Qliphothic manifestations within the Sephirothic side of the Tehiru.

These talismans, being seven in number, are to be inscribed with the tip of sharp consecrated iron upon clay tablets made by mixing cleansed and consecrated clay, obtained from a suitable place during a favourable time, with which mineral, animal and plant elements sympathetic to the Kingdom that each tablet is to connect to are mixed and finally libation and blood offerings are poured over the mixture, which then is stirred while being empowered through the vibration of the Names of Power and other Formulae connected to the Hell Gate that they are being dedicated to. The clay is then shaped and left to dry upon the altar in-between two black pillar candles inscribed with the relevant seals and Names of Power throughout the whole drying process.

The shape of these tablets can be round or angular, if the latter form is fashioned the hendecagon form is the most preferable, even if also other geometrical shapes more directly related to the planetary spheres corresponding with each also can be used (in the same vein also planetary metals can be employed instead of clay, by those who can figure out the correct correspondence, access the metals and form them correctly according to need and consecrate them duly with the secret elements bearing the virtues of enlinkments required for the forging of the Chain of Sympathy, leading from this to the Other Side).

Before the tablet is fully dried, somewhere during the halfway of the drying process, the holes needed for the suspension of the talisman are to be made, with for example the flat tip of a suitable sized thin rod, as the risk of cracking and breaking the tablet is otherwise much greater if the holes are made after the clay has become too dry.

When the tablet is dried and ready it is first sandpapered in order to make it as smooth as possible and then the Gate Seal is inscribed on the front side and Qlipha or Qliphoth seal/s are inscribed on the back. The tablet is then painted first black and when the black paint has dried the inscribed seals are painted in red. The talisman receives its final empowerment in manner similar to how the Black Mirror Gate was, by being placed upon the corresponding Hell Gate Seal during its ceremonial activation and the Qliphothic forces evoked are adjured to fully bless the talisman so that it may lend strength, protection, power and focus to all future workings related to it and connected to Them. After its consecration the talisman is to be wrapped in black silk marked with the corresponding Hell Gate Seal and employed as a shield and a Talismanic Point of Power and Authority worn during all related operations and can be hung around the neck by the addition of a suitable metal ring to the hole/s through which a fitting chain or leather cord can be threaded.

There are many other practical uses of these seals of varied and different level of elevation and intensity, like for example the affecting or afflicting a whole area by the cunning application, sowing and activation of these seals, or by placing links to the target upon such seal and by its activation channelling the currents of the Kingdom into the being of the person in order to cause empowerment and illumination or life-shattering disruption via wrathful malediction.

Besides the mentioned approaches and many other similar applications of the Seal Gates through their physical formation and activation they also serve a multitude of purposes on the more subtle planes, where they are marked mentally and astrally and activated through more internal methods of force-direction, by the power of Will and Spirit and the employment of formulaic vibrations directed to turn the seven keys and open wide the Gate, like for example when working directly on the Yetzirahic/astral levels as in the following chapter describing the simpler ritual for the astral Opening of the Seven Gates of Hell.

By establishing and empowering each Seal Gate correctly on the astral they can for example also be used as the concrete gateways through which the Oneiric Body can enter each Kingdom astrally and attain both wisdom and power directly from the Source, but the exact initiation into such mysteries, which are veiled in more shrouds than what they initially may seem to be, must be left to the Serpentine Overseers of this our Path, Current and Tradition.

In the most esoteric aspect of the Work each of the Seven Points of Power or Keyholes within each Hell Gate Seal are also attributed a Daemonic Guardian and Key-Bearer, which once contacted and contracted can be called upon in order to lend aid to all operations aimed at the full opening of each of the gates, in manners and for purposes even more powerful than those already mentioned.

Let the cunning forge the initial Keys to the Gates by that which already has been disclosed and hinted at, so that in time even farther, deeper and more hidden aspects may open up in order to let in the Glorious Light of the Other Side and usher the Black Dawn of Thoughtless Divinity.



The Opening Ritual of the Seven Gates of Hell

The following ritual serves to open up certain layers of the astral points connected to each of the Seven Hell Gates in order to channel power and Black Light from each of the Seven Kingdoms of Qliphoth and at the same time open the pathways that enable communion with the Spirits of Sitra Achra. The ritual can as such be one of the initial steps taken before other Qliphothic Workings.

Not only does this ritual call upon the forces of Divine Thoughtlessness from the Seven Kingdoms but it also aids to dispel aspects of those cosmic influences that naturally are opposed to Qliphothic intrusion and influence and does as such also act as a banishing of those profane forces while at the same time granting At-Azothic quickening to the Black Flame Within, which constitutes as the primary inner link to the El Acher, whose Outer Light that Inner Flame reflects.

1. Place on the ground at the centre of the ritual area the straight and the crooked wand, 11 black candles, box of matches, consecrated chalk and all other tools and elements that you may need for any follow-up rituals.

Mark out the eleven points of a Hendecagon measuring at least two metres in its circumference, with first point facing the North, on the ground where the sacred liminal space is to be established.

Place a cleansed and properly dedicated candle on each of the eleven points and starting with the Point of Satan and moving widdershins, in the encircling succession of the

establishing of the Hendecagon instead of the reflective one of the Hendecagrams, light each candle with an individual match and intone one part of the following Elevenfold Formula of the Concealed Heads of AZRAT over each flame lit:

*Samobelu * Asasbeba * Adlina * Taloel * Citamo *
Lfalraliam * Nkzefu * Rodaeg * Tzemethah * Bubgethy *
Orlmothlek **

After the intoning of the final word of the Formula of the Concealed Heads face the first candle, intone again the whole formula and for each of its parts envision with the Eye of Spirit how a line of black fire spreads from the corresponding Enflamed Point and connects to the next, so that by the final intoning of the word Orlmothlek the eleventh point becomes by the spreading line of black fire connected to the first and a protective and empowering fiery Hendecagon becomes created around you.

This is to be understood as a form of withdrawal from the cosmic side of the void, an act similar to the primal Tzimtzum, but here on a subjective and strictly personal level, separating yourself from the surrounding world and creating a connection, based on intention as expressed and manifested through rite and formula, instead to the Other Side and its Eleven Heads.

2. Pick up the straight wand and with it inscribe the simple form of the seal of the Gate of Gehinnom in the astral towards the ground with the Black Fire of Imagination, Will and Spirit channelled outwards through its tip:

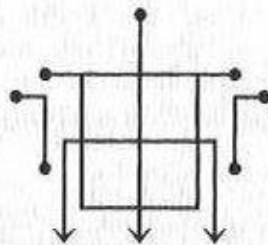

When the seal is established firmly chant seven times the following formulaic petition to the forces reached through the seal, with focus being shifted from one Point of Power, or Keyhole, to the next for each recitation:

Ama Lilith Savta va-Naamah-Nahema, Liftoach Shaari ha-Gehinnom! (x7)

After the seventh recitation directed at the seventh point of the seal let the Spirit's Eye behold the whole seal blaze up forcefully and at that time project it deep into the ground at the centre of the surrounding Hendecagon and seal its sowing and establishment in the place below with an elevenfold knock on the ground with the tip of the wand.

3. Face the North side of the Hendecagon border acting now as a liminal limit starting to intersect more and more with the Other Side and trace the simple form of the seal of the Gate of Shaarimoth before you with the tip of the wand:

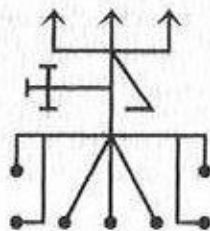

Enflame it and when the seal is established firmly chant the following formula seven times, with focus directed in similar

succeeding manner as with the earlier gate between its Seven Points of Power:

Adramelek ha-Sam-El-Acher, Liftoach Shaarimoth! (x7)

After the seventh recitation directed at the seventh point of the seal let the Spirit's Eye behold the whole seal blaze up and then let it be projected forward into the Tehiru and seal its establishment at the northern cardinal point with an elevenfold knock on the ground with the tip of the wand.

4. Face the West side of the Hendecagon border and trace the simple form of the seal of the Gate of Tzelmoth before you with the tip of the wand:

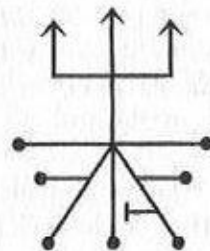

Enflame it and when the seal is strongly established chant the following formula seven times, with focus directed in similar succeeding manner as before towards the seal's Seven Points of Power:

Baalbaalath-Anamlaqayin, Liftoach Shaari ha-Tzelmoth! (x7)

After the seventh recitation let the whole seal blaze up and project it forward into the Tehiru and seal its establishment at the western cardinal point with an elevenfold knock on the ground with the tip of the wand.

5. Face the South side of the Hendecagon border and trace the simple form of the seal of the Gate of Bar Shachath before you with the tip of the wand:

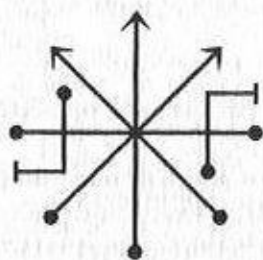

Enflame the seal and when it is strongly established chant the following formula seven times, with focus directed again towards the seal's Seven Points of Power:

Baal-Belfegor, Liftoach Shaari ha-Bar Shachath! (x7)

After the seventh recitation let the whole seal blaze up and project it forward into the Tehiru and seal its establishment at the southern cardinal point with an elevenfold knock on the ground with the tip of the wand.

6. Face the East side of the Hendecagon border and trace the simple form of the seal of the Gate of Tit ha-Yon before you with the tip of the wand:

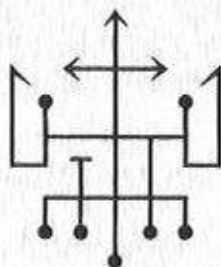

Enflame the seal and when it is strongly established chant the following formula seven times, with focus again shifting between the seal's Seven Points of Power:

Esh-Moday-Melek, Liftoach Sharri ha-Tit ha-Yon! (x7)

After the seventh recitation let the seal blaze up and project it forward into the Tehiru and seal its establishment at the eastern cardinal point with an elevenfold knock on the ground with the tip of the wand.

7. Face upwards and trace the seal of the Gate of Abaddon towards the heavens with the tip of the wand:

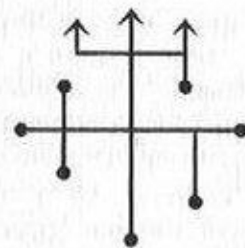

Enflame the seal and when it is strongly established above you as a Crown of Fire chant the following formula seven times, with focus again shifting between the seal's Seven Points of Power:

Astaroth-Nachash-Yabal, Liftoach Shaari ha-Abaddon! (x7)

After the seventh recitation let the seal blaze above you and project it into the upper Tehiru and seal its establishment at the point of zenith with an elevenfold knock on the ground with the tip of the wand.

8. Turn towards the North and trace the simple form of the seal of the Gate of Sheol ha-Tehom in front of you inside of the Hendecagon with the tip of the wand:

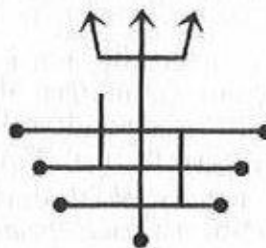

Enflame the seal and when it is strongly established in front of you within the perimeter of the Hendecagon chant the following formula seven times, with focus again shifting in sequence between the seal's Seven Points of Power:

Lucifuge Rofocale, Baal-Zebub, Molok va-Ha Satan, Liftoach Sbaari ha-Sheol ha-Tehom! (x7)

After the seventh recitation let the seal blaze in front of you and instead of projecting it outwards as with all the other seals take instead with the left foot first a step into its black fires and let it be absorbed into your own soul and Spirit and seal its establishment at the central point within by an elevenfold knock on the ground with the tip of the wand and then cross your arms, left over the right, over your chest to form the X-Mark of Tav and chant the following formula eleven times and for each recitation feel the Black Fires of the Supernal Kingdom of the Qliphoth burn stronger within and unite with and empower your own Inner Black Flame of Spirit:

Vedar-Gal Tiekals Somdus Azerate!

9. Place the straight wand on the ground and pick up in its stead the twisted one. Point that serpentine wand to the place below and chant once the following Formula for the Opening of the Seven Gates of the Eleven:

Azerate Samobelu Asasbe Baadlina Anokubal Othayor Othekithah!

Behold with your mind's eye a black sphere of light manifest below you where the Gate of Gehinnom has been opened.

Repeat this whole process of pointing to the directions of the gates and chanting the formula until also the northern, western, southern, eastern, upper and inner gates have been given attention to, the formula chanted all in all seven times and the seven black spheres stand shining within those points leading to the Other Side that now have been fully established.

10. Point with the tip of the twisted wand towards the Gate of Gehinnom below and chant:

Liftoach Sbaari ha-Sitra Achra! (x7)

After the seventh recitation pull and channel through the tip of the wand towards and into yourself a ray of Black Light from the sphere of Gehinnom and let it become attached to the central point within.

Repeat the same process by pointing to and channelling Black Light from each sphere and connecting their rays into yourself by employing the following formulae:

Point towards the Gate of Shaarimoth and chant:

Liftoach Sbaari ha-Olahm ha-Qliphoth! (x7)

Focus on the Gate of Tzelmoth and chant:

Liftoach Sbaari Ha-Ilan Ha-Hizon! (x7)

Focus on the Gate of Bar Shachath and chant:

Liftoach Sbaari ha-Reshut ha-Rabbim! (x7)

Focus on the Gate of Tit ha-Yion and chant:

Liftoach Sbaari ha-Aur She-Ain Bo Machshavah! (x7)

Focus on the Gate of Abaddon and chant:

Liftoach Sbaari ha-Olahm ha-Tanninim! (x7)

And finally focus on the gate of Sheol ha-Tehom at the centre, within yourself, and chant:

Liftoach Sbaari ha-Umka de-Tehoma Rabba! (x7)

By the last intoning of the formula of Sheol ha-Tehom see and feel the sphere within blaze up and gain power in and through its connections to the other spheres that now have been established.

11. Cross your left arm over the right in the X-Mark sign of Tav and strongly focus, in turn, upon each of the beams of Black Light connecting to the Gate Within, which should be envisioned as black sphere of fiery light filling up, shining and pulsating within the chest and solar plexus area. Do so by chanting the following formula seven times while further channelling Thoughtless Light from each gate towards and into yourself:

Aur Shachor ha-Qlipboth Leha'ir!

Finally and for the seventh time chant the Aur Shachor formula while opening your arms and holding them out to the sides in the Sign of the Cross and envision in ecstasy the black fiery rays of the Light of the Other Side spiralling now in serpentine form towards and intersecting through you, creating the Infernal Crossroads of the four cardinal points penetrated by the vertical pillar, opening up the sevenfold liminal point of ingress and congress within, through and around you and in ecstasy proclaim:

From the Underworld the forces of Gehinnom are with and within me!

From the North the Forces of Shaarimoth are with and within me!

From the West the forces of Tzelmoth are with and within me!

From the South the forces of Bar Shachath are with and within me!

From the East the forces of Tit ha-Yion are with and within me!

From the Above the forces of Abaddon are upon and within me!

From the Centre the forces of Sheol ha-Tehom are with and within me!

Surrounded am I by the Dragons Of the Other Side, coiling around and rising within me, as they with their Fires increase the flow and expansion of Spirit, shattering all that would restrict the Thoughtless Impulse from returning the Divine Flame back towards its Unmanifest Source!

Tehomoth Theli Thaumithan Rabab Leviathan Tanin'iver Taninsam!

By the Sevenfold Emanation of the Dragons of the Other Side the powers of the Eleven are called upon, connected to and now manifested!

Hail the Seven Kingdoms of Divine Thoughtlessness and its Eleven Governing Heads!

Atab Gibor Le-oblam Azerate!

Envision the Dragon-Force spiralling into and within you, connecting the Other Side to you and you to the Other Side and maintain this vision and ecstatic feeling as long as possible or necessary and when ready either commence a deeper meditation, astral projection or any other follow-up working.

When done hold the straight wand in the right and the twisted wand in the left, cross your arms over your chest and turn in a reversed order as to how you originally called upon, established and opened each gate and give to each Kingdom and its Governing Heads praise and thanks and finally extinguish all candles by snuffing them out also in a reversed order as to how you originally lighted them, this in connection to the reversed employment of the Elevenfold Formula of the Concealed Heads of AZRAT in such way that the eleven parts correspond to each candle being extinguished, starting with Orlmothlek and ending with Samobelu, intoning the corresponding word into each flame before its extinguishing.

Within this general outline of the described working there are purposely left many possibilities for the expansion of the rite by for example the correct addition of the Opening Formulae of the Gates, which now are left out, and other steps and elements such as the employment of the thurible and the different incenses corresponding to each of the Seven Gates. These and other omissions are meant to allow the student to apply the personal knowledge that he in time shall attain, so that via such initiatically gained insights he may evolve the outlined ritual and thus enter deeper into the mysteries and further explore and partake of the Current of Qliphoth in its Sevenfold Expression.

Within this simple form of the Opening of the Seven Gates there are also many formulae given that also can be employed within other related settings and when the mysteries have as the reward for hard and correct work become revealed the true potential of this rite, as the seed of many other relevant workings, will become understood. Mysteries are left in darkness so that only the Enlightened Ones may approach them, and as such more is given here again in concealed form than in revealed.



The Star of the Eleven = The Qliphothic Magic of the Hendecagram

Many are the individual seals belonging to the countless different aspects of the forces of Sitra Achra, as shown in this book, and they all do possess strong enlinkments to the Dragons of the Other Side, but there is one set of symbols that even if they primarily can be said to represent the Eleven Heads also represent the whole of the Elevenfold Qliphoth with connections to all that exists in the Realm of Wrathful Thoughtlessness.

This set of symbols consists of the geometrical Eleven Pointed Star configurations called Hendecagrams, described exoterically as star polygons possessing eleven vertices, existing in four regular forms, having each at their centre/heart the Hendecagon, which in itself represents the expanding border manifested through the Eleven Primal Points of Thoughtlessness, hindering the intrusion of the Thoughtful Light's shining forth through the Tehiru. The Hendecagon as we shall show represents also the Eleven expressed through One and the One Manifested through Eleven and is as such a symbol for the expansion, division and unification of the Divinity from the Left Side of Ain Sof, acting with the aim of nullifying the Cosmic Thoughtful One and returning itself to its Fullness of Emptiness in Ain (1-1=0).

We shall first present the different forms of the mentioned symbols and explain their relevant attributes and meanings within the context of our Qliphothic Work and later describe how they practically are employed as the Elevenfold Pathways through which the essences of the Other Side are reached and the cosmic barriers broken and breached.

The Eleven Primal Points

The seed-form for the manifestation of the Hendecagram is the Eleven Primal Points, representing the first Anti-Cosmic thought of the Thoughtless Light, being its adversarial stance assumed against the restrictive and static 10 of its cosmic counterpart. These eleven points are the divided aspect of the first anti-Sephirothic impulse manifested within the abyssal Tehiru and from these eleven seeds the whole of the Outer Tree of Death germinated and flourished and through the same Eleven Points Azerate gained its Heads, Crowns and Thrones.

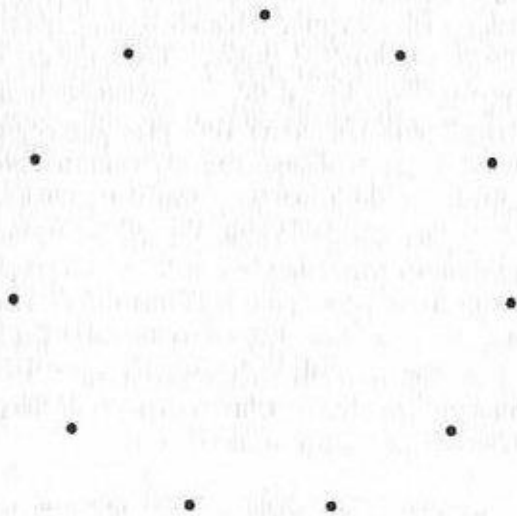

From these Eleven Points the Black Light emanated and reflected and in its first aspect reflecting from each point to the next it created the borders of its own Domain of Exile and Opposition within the side of the Tehiru it had been made to reside within, in order to hinder the expansion of the falling, felling and limiting Thoughtful Emanations. This first shining forth by the Black Light is described as an anticlockwise reflection between its established points, starting from the first point at the top connected to the Three Veils of Anti-Existence, being in ascending order Chasek, Bohu and Tohu, which at the Zenith of Thoughtlessness by its Formless Chaos remained as the strongest link to Ain, and by encircling the Void it created the borders both restricting the Thoughtful Side from expanding further and created the liminal points of intersection through which that Sephirothic side could be intruded and dissolved back to Thoughtless Unity.

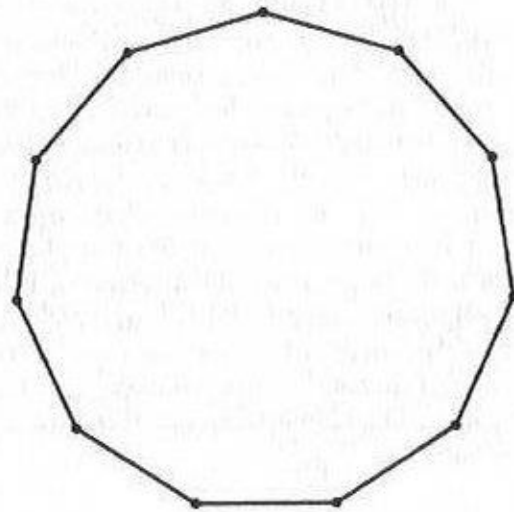

By this first motion of the Eleven through the Primal Points the Hendecagon became established as a shield with cutting edges, protecting what would remain within, while at the same time burning with Fires of Qliphoth that which would seek to penetrate it from without. The Hendecagon is thus the first reflection of the Black Light reverberated from every point of the Eleven and is as such the Anti-Cosmic manifestation of the Thoughtless 11 opposing the Thoughtful 1, which in contrast to the limiting circle of the Sephirothic side of the Tehiru, having the numerical value of 10, is not static but instead expansive, dynamic and invasive as each angle of the hendecagon emanates points cutting into the void and spreading its Burning Light when forming Hendecagrams and instead of limiting and surrounding such stars takes the seed-position of their transmutative becoming at their centre/heart.

While the Eleven Seed Points and the Hendecagon represent the first primal impulse of structure and manifestation, albeit in a chaotic and lawless form, it does so in a formless manner and can be likened to the stage before and leading to the actual Qliphothic Creation, making way for the still unmanifested Four Worlds of the Atziluth, Briah, Yetzirah and Assiah of the Other Side, which are to come into existence through the four different approaching formations of the Hendecagram. The Hendecagon is thus rightly to be understood as the structuring emanation from Tohu, Bohu and Chasek, carrying out the will of Qemetiel, Beliel and Athiel to fully oppose the way of YHVH and lays the ground and plants the 11 seeds of Qliphoth and the great Work of HVHY and can from such esoteric perspective be connected to the Spirit's Unique Thoughtless and Quintessential soul aspect of Yechidah.

The First and Atziluthic Hendecagram

The first Hendecagram manifesting and representing the Qliphoth on the highest level becomes created when the Eleven Primal Seed Points reflect the Black Light from every second point, manifesting thus the First through the 2, instead of the Sephirothic 1, reflecting how Kether is a manifestation of the 1 while Thaumiel is manifested as the primal 2, this mirroring perfectly the dual point of Thoughtless Manifestation countering the singular and static point of Thoughtfulness. This first form of the Hendecagram, reflected from every second point, creates thus the impulses of the Eleven Heads of Azerate within the Atziluth of Sitra Achra, being the world of Black Light manifested through Spiritual Fire as the Archetypal World of Qliphoth.

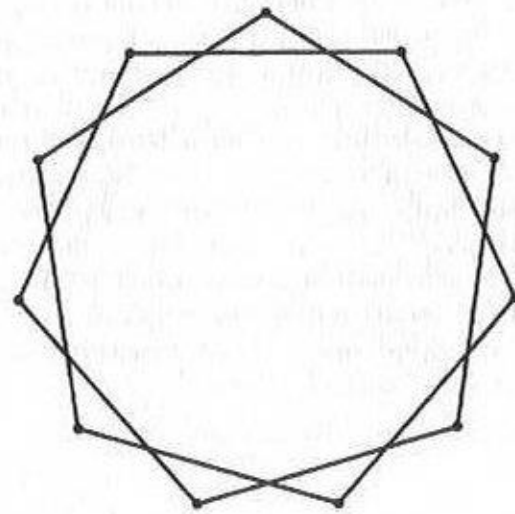

This first form of the Hendecagram of Atziluth represents the 11 in its most lofty manifestation and station as pure burning instinct, impulse and Anti-Cosmic intention and is the First Manifested As and Through the Two, giving opposition to the Yod of the Cosmic Tetragrammaton and is as such a direct source for the coming forth of, but also the returning back to and through, of the Dual Essence of the Black Flame of Spirit, which can be described as the Thoughtless form of the vital Chiah, belonging to all the Serpents and Dragons of the Other Side and their spawn dwelling on both sides of the Tehiru.

This First Form of the Hendecagram represents the World of Pure Emanation from the Three Veils of Anti-Existence remaining connected to Ain and holds the power of the Supernal Crown of the Dragon and the Black Light burning within and without, motivating the struggle against Thoughtful Existence and finite life, causing the attraction and pull towards the Unmanifest Fullness of Emptiness. Within the world and through the power of this Hendecagram the Fire of Will and Spirit are cultivated and made to blaze forth in order to annihilate the cause of restriction at its seed point of germination, in order to further acausal freedom, liberation and Thoughtless Ascension. By this star the eleven Heads, Crowns and Thrones are first established in the most elevated station beyond comprehensible manifestation, leading when moving downwards towards opposition against all that would limit its shining forth and guiding, when moving upwards towards the Three Dark Veils, back into the Womb of Ain.

The Second and Briaheic Hendecagram

The Second Form of the Hendecagram represents the Qliphothic World of the Thoughtless Impulses concretised as Thoughts of Anti-Creation, opposing the prime Heh of the Thoughtful Tetragrammaton and its diluting element of water, here instead bringing forth the Silencing Roar of the Tehomothic Seas of Thought-Shattering Spirit, taking form and manifesting by the Black Light being reflected through every third Primal Seed Point, causing the manifestation of the 11 through the 3 in order to combat the 10 through the 2 of the Sephirothic Side, manifesting the Hendecagram of Qliphothic Briahe and the Mental Point of Intrusion and Usurpation of cosmos and the Elevenfold Point of Rectification and Elevation in Sitra Achra.

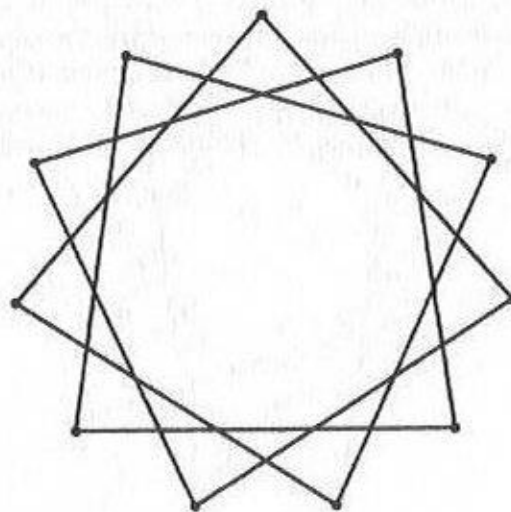

This second form of the Hendecagram represents the Thoughtless Atziluthic Impulses of the 11 paradoxically conceived as the Briahic structured thoughts of the Eleven Heads of the Dragon and thus another step in the self-sacrifice of the Left Side of the Ain Sof restricting itself further in order to attain the Liberation of All via the nullification of the thoughts of its Thoughtful Side. By this symbol the Spirit is expressed through Transcendental Awareness, Acausal Intuition and Apprehension of the Truth Beyond All Forms, breaking free from the limiting mind and thought and reaching upwards, backwards and through the Silence holding within itself All-Knowledge and Alogos of the Highest Gnosis.

This Hendecagram manifested by the Echoes of the Voiceless Call of the Unmanifest Returning to its Source is as such a link to Neshamah, being the part of the Soul through which the Spirit is expressed by being as a Chalice filled with the nectar of the Atziluthic impulses condensed and distilled to yield the essential foundation for the actual manifestations which are to follow the Second World of Qliphoth it belongs to and is as such a precondition for the realization of the Anti-Cosmic Will of the Qliphothic World of Supernal Dragons.

The Third and Yetzirahic Hendecagram

The third form of the Hendecagram and its Qliphothic world of Yetzirah opposing the work of the Vav of the Cosmic Tetragrammaton, caused into being by the Reflection of the Black Light through every fourth Primal Seed Point of the Eleven, represents by the 11 through the 4 the antithesis to the Sephirothic World of Formation, which is the 10 through the 3, where the Briahic ideas are given actual forms as the astral-blueprints and the Atziluthic impulses turned into Briahic thoughts here manifest as Yetzirahic forms and emotions motivating and provoking the direction of force towards full manifestation via action and creation.

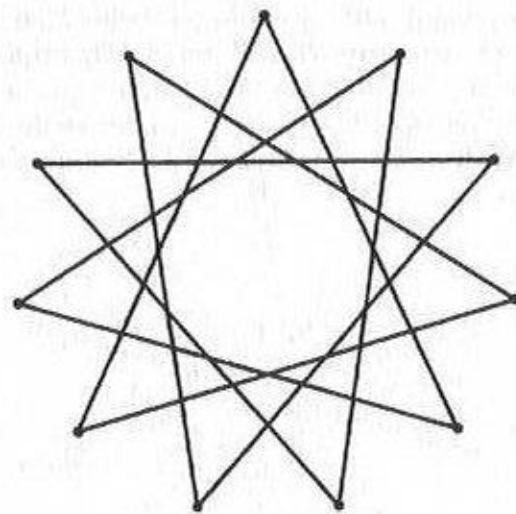

This third form of the Hendecagram represents the Thoughtless Divine Impulse in its aspect as the light casting the shadows of materialisation and is as such the final step before crucifixion upon the cross of matter, or the sending forth of Emanations of the Divine meant to remove the nails driven in by the Thoughtful Impulse in order to unloosen Spirit from the Fourfold Cross of Matter. Within this Yetzirahic World and through its Hendecagram the world of dream, emotion, and the Soul is uplifted from the restrictions of the Sephirothic side upon the breath of the Dragon causing the Ruach to soar and leave behind in ashes that which would by law and causal restriction bind Spirit through it to the fallen state of stasis within materialisation.

This third Hendecagram is within some contexts considered the Gate of Souls as the breath of the living and the dead can through it become inhaled into the Other Side by its vampiric reflex towards the Sephirothic side it combats and seeks to drain of all essence and can as such also act as the astral gate through which the Qliphoth is entered or its forces invited to invade through for the sake of their addition to the Spirit making the corresponding vessels crack and set free that which they by the impulses of the deranged Fallen Thought hold captive.

The Fourth and Assiahic Hendecagram

The fourth and last regular form of the Hendecagram, representing and manifesting the antithetical impulse against the Material World of Assiah, giving birth to the Qliphothic Antiverse, and the full embodiment of the once Atziluthic impulse to revert the creation of the Thoughtful Side back into Ain is the gate of physical invasion from, or escape to, the Sitra Achra, opposing the final Heh of the cosmic Tetragrammaton by the formula of inversion and reversal, acting either as the Point of Liberation or At-Azothic intrusion and Anti-Cosmic disruption. Through this Assiahic Hendecagram, manifested by the reflection of the Black Light through every fifth Primal Seed Point of the Eleven, antagonising and overcoming with its 11 through 5 the Sephirothic enslavement of Spirit accomplished through the cosmic 10 through 4, is a flourishing of the Thoughtless Impulse which came into being at the Atziluthic level, became sowed on the Briahic, cultivated at the Yetzirahic and here harvested through its Assiahic outcome.

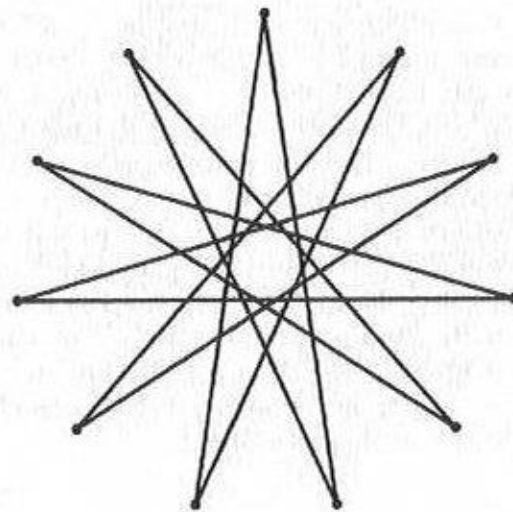

This fourth form of the Hendecagram represents and manifests the Pentagrammaton of the Elevenfold El Acher and the Womb of the Dragon through which the Messiah of the Serpents shall be reborn in order to bring salvation to the Spirit, which is something perfectly reflected in the fivefold essential aspect of the Qlipha representing the culmination of Assiahic manifestation, in contrast to the fourfoldness of its Sephirothic counterpart as manifested through its tenth, uplifting by the grace of the 11 through 5, the Quintessence that the cross of the YHVH otherwise would keep crucified. This makes the most practically employed functions of this fourth Hendecagram, which is to cause embodiment and materialisation of evoked Qliphothic forces within suitable forms, seemingly paradoxical but as all such Demiurgically Unthought and thus Unfated Intrusions since after the division between the two sides of the Tehiru are Anti-Cosmic and disruptive in nature, and because of the Kelim-Shattering At-Azothic effect it inevitably causes by the addition of the Black Fires of Divinity to the forms that can not withstand more than what they were conceived to contain, all such manifestations serve the cause of the escape from the four and the liberation of, and through, the fifth.

The fourth Hendecagram is thus both the Gate of Enspiritment and the route through which Spirit bound by the lowly domesticated animal soul Nefesh may be turned into a Wild and Free Beast breaking its chains in order to escape its limiting embodiment, all depending on if the First Primal Seed Point is used as the Gate of Ingress into, or reversed to become a Point of Egress from, incarnation. The elevating potential of this Hendecagram can also be discerned by the fact that it holds within itself the forms of all the other three Hendecagrams which it succeeds and thus via the formula of HVHY it can be used as a Ladder of Ascent uplifting the Spirit from the Earthly manifestation in Assiah back to the Immaterial Fire of Atziluth.

The Pan-Qliphothic and Unified Hendecagram

Besides the mentioned four regular forms of the Hendecagram there is also a Fifth and Unified Form. This Pan-Qliphothic aspect represents the Fullness of Sitra Achra as it places in layers, upon and within the same space on top of each other, by the Black Light emanated from the same Eleven Primal Seed Points the Hendecagon of the Abyssal Void and all the four forms of the Hendecagram, creating a symbol encompassing all aspects of the Qliphoth by its 11 being reflected through 11 and is as such also representing the elevation of the Eleven back to its own Points of Emanation, without the entanglements that all of their other forms because of their antagonising aspects possess to the Sephirothic Side, making this symbol a most transcendental one and another Seal of Azerate, the Eleven-Headed Dragon of Thoughtlessness.

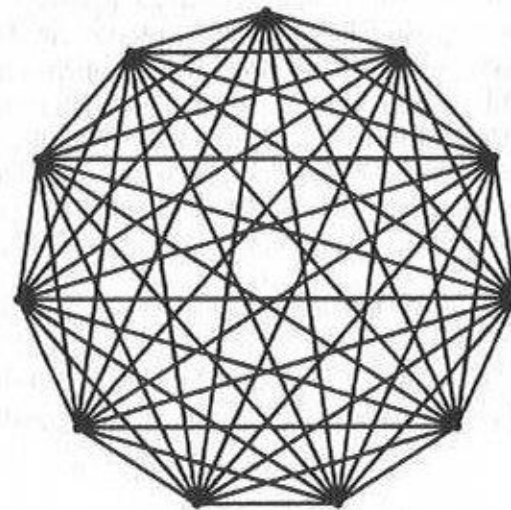

Within this Pan-Qliphothic Hendecagram the Hendecagon at the centre/heart is esoterically linked to the Womb of the Unmanifest Dragon, representing the gateway from, but also to Chasak, Bohu, Tohu and the Ain to which the Formless Chaos of Tohu is the final step. The workings and mysteries of this Unified Hendecagram can therefore be approached when the meanings and powers of the other four regular forms have been experienced and internalised, as this final evolution of the reflecting rays of the Black Light angled through the prisms of the Primal Seed Points of Thoughtlessness is on the deepest level to be approached and employed from the perspective of a Spirit projecting its focal point from the Sitra Achra upon its Self and is as such reserved for those that would become in mind and soul as those Dragons of the Other Side, opposed to the Sephiroth and at the same time free in detachment from its governing and restrictive causality.

Approached from a more simple perspective the Pan-Qliphothic Hendecagram can be employed as a Point of Empowerment through which anything already connected to the Qliphoth can become strengthened in essence by the causing of the concentration of its emitting Black Light to reflect through the Eleven Points back upon itself, but also by the fortification of all of its links back and forth to Sitra Achra and can as such be employed as a Seal of Consecration upon which Spirit-Vessels, talismans, the magical weapons and tools can become blessed.

Practical Applications of the Stars of the Eleven

Now that some of the esoteric attributions and symbolic meanings of the different Hendecagrams have been disclosed we shall move to the actual applications of these powerful Eleven Pointed Star Seals connected to the worlds of Sitra Achra and mention a few of the many ways through which they can be employed within the Qliphothic Workings in order to access the Black Light which can be made to reflect through them in different directions, by those that within them carry a Flame of That Light.

Within certain settings the Hendecagrams can be employed in a simpler, more exoteric and representative/symbolic manner, in contrast to the esoteric operative fashion through which they otherwise are employed when meant to by their very tracing and activation cause the manifestations of the aspects of the Qliphoth they are enlinked to. Within those simpler applications of the Hendecagrams as mere Talismanic Symbols they constitute as representative forms of the essences they can be connected to. Within such settings the symbol as a whole is focused upon and charged with power through the meaning and attribution ascribed to it and within such contexts many different extra elements can be added to it, like for example different seals, signs, names of power or written formulae, in order to empower the talismanic symbolism and form and thus also its receptivity for the charge it is to receive during its consecration and so expand its potency to connect to, amplify, hold and emit its intended power.

There are for example different words and phrases that are of great relevance and hold immense symbolic value when it comes to the contexts to which these Hendecagrams belong, among these some of the most obvious ones are the following:

ש Shin - Sh
 א Aleph - A
 י Yod - I
 נ Nun - N
 ב Beth - B
 ו Vav - O
 מ Mem - M
 ח Cheth - Ch
 ש Shin - Sh
 ב Beth - V
 ה Heh - H

Spelling out She-Ain Bo Machshavah, being a phrase spelled with the eleven letters meaning Without Thought, implying the Thoughtlessness of the Black Light as expressed through the Eleven.

Another example is:

א Ayin - silent A
 ו Vav - O
 ל Lamed - L
 מ Mem - M
 ה Heh - H
 ק Qoph - Q
 ל Lamed - L
 י Yod - I
 פ Peh - P
 ו Vav - O
 ת Tav - Th

Spelling out Olahm ha-Qliphoth, another phrase spelled with eleven letters meaning the World of Qliphoth, a synonym to Sitra Achra, expressing how the whole existence of the Other Side is founded upon the Elevenfold Expression of Divine Thoughtlessness.

As a third and last example we can give the following:

ש Shin - Sh
 א Ayin - A
 ר Resh - R
 י Yod - I
 ה Heh - H
 ק Qoph - Q
 ל Lamed - L
 י Yod - I
 פ Peh - P
 ו Vav - O
 ת Tav - Th

Spelling out Shaari ha-Qliphoth, meaning the Gate of Qliphoth, showing again with its eleven letters how the Eleven is not only the foundation of the Qliphoth on the Other Side but also how it is the means through which Sitra Achra can be accessed from this Sephirothic side of the Tehiru by the opening of the gates of the Eleven freeing the Spirit and at the same time letting in the invasive Qliphothic emanations.

When talismanically employed the Hendecagrams can depending on their intended uses for example be adorned by the letters of phrases such as the above mentioned ones, or other equally relevant combinations of letters or symbols, in order to focus the intention behind and the direction of the power sought through the employed symbol and thus emphasise its, at the time, most relevant attributes.

Within the more esoteric settings these Stars of the Eleven are on the other hand utilised as Operative Tools of Qliphothic Sorcery, employed not only as mere representative images but as concrete physical, astral, mental and spiritual tools, which must be formed, charged and activated in a correct manner in order to yield exact and specific results. For example it is of a great significance to establish the Primal Seed Points and then trace from them correctly the lines, representing always the Rays of Thoughtless Light, in a correct manner based on

the desired result and the aspects of the Eleven focused upon and reached for.

Based on which form of the Hendecagram used the position of all but the First Throne and its corresponding Seed Point will change in accordance with how the lines are reflected and as such even though the Seed Points always remain the same the positioning of the Ruling Heads and their Seats of Power manifesting through them will shift depending on which aspect and within which of the Four Worlds the focus is shifted to.

Within the Operative/Gate Opening settings each stroke must reflect correctly the succession of Qliphothic emanations in order to connect to them and thus activate the Spiritual Power of the symbol.

There is also another set of variation when it comes to the forms, powers and sphere of application of these symbols, dividing them into two different groups, one being the Evoking/ Invoking forms, which are the usual versions with the First Point pointing upwards, and the other being the Egressive/Ingressive forms which are the inverted aspect of the Hendecagrams, with two points facing upwards and the first point instead turned to occupy the nadir of the star.

The Invoking/ Evoking Hendecagrams

The Hendecagrams in their usual forms depicting the forming of the Qliphoth by the reflection of the Black Light through the Eleven Points and the intersecting lines and angles so created are all employed as Invoking or depending on the work at hand Evoking seals, because in the same manner that they show how the forces they can be connected to came into being on the Other Side they can also on this side call upon their presence and manifest their essences in different ways.

Each point of the Hendecagrams is attributed to one of the Eleven and depending on which of them it is that one needs to call upon the tracing of the Hendecagram will of course start at that corresponding point, emanate to and reflect through all other points and finally reverberate back to its own starting point and thus seal the power called upon through it. The motion of the reflection between the Eleven Points will always be anticlockwise and leftwards moving, as the Path Against the Sun is the Way of Turning Towards the Other Side and the Left is the Side of the Antinomian, following the Lawlessness of the Other God while breaking the commandments of the cosmic enslaver and transcending his limitations.

The following are the Reflective Points of the Hendecagrams of Atziluth, Briah, Yetzirah and Assiah of Sitra Achra, showing the positioning of the Eleven Rulers upon each Star of Qliphoth and marking out their Points of Manifestation from and back to which the lines of their invoking or evoking Hendecagrams are reflected. By these following examples it is also possible to figure out how the 10 Qliphoth (with Thaumiel being Twofold) and the Seven Hells (with Sheol ha-Tehom being connected to 4 points and Gehinnom to 2) can be attributed and linked to the points of the different Hendecagrams presented.

The Atziluthic Reflective Points of the Eleven Rulers

Satan
•
Belfegor • • Asmoday

Molok • • Na-Ama-De-mah

Baaltzelmooth • • Astaroth

Beelzebub • • Lilith

Adramelek • • Lucifuge
Kofocale

The Briabic Reflective Points of the Eleven Rulers

Satan
•
Astaroth • • Baaltzelmooth

Adramelek • • Lucifuge
Kofocale

Molok • • Na-Ama-De-mah

Asmoday • • Belfegor

Lilith • • Beelzebub

The Yetziratic Reflective Points of the Eleven Rulers

	Satan	
Lucifuge • Kofocale		• Adrameleh
Belfegor •		• Asmoday
Lilith •		• Beelzebub
Molok •		• Na-Ama-De-mah
Astaroth •		• Baaltzemoth

The Assiatic Reflective Points of the Eleven Rulers

	Satan	
Lilith •		• Beelzebub
Baaltzemoth •		• Astaroth
Asmoday •		• Belfegor
Lucifuge • Kofocale		• Adrameleh
Molok •		• Na-Ama-De-mah

The tracing of each star and its activation can be accomplished in different ways, but the primary aspect of the Work takes always form by the marking out of the Eleven Points and then depending on if the ceremony is aimed at invocation or evocation either the operator acting as the medium or the seals, talismans or fetishes are placed at the centre of the space surrounded by the Eleven Points, before the lines are traced and the centre is sealed by the Hendecagon manifesting as the heart of the Hendecagram. The tracing of the lines can be done either by the way of carving/scratching, ploughing, painting, marking, strewing, by the way of smoke and fumigation, by combustion and blazing fire or by the spilt blood of a sacrifice.

Carving and scratching is done upon suitable surfaces by the point of the dagger or the sword, or by the sharp end of any other relevant tools fit for and dedicated to the task at hand.

Ploughing is done when working upon the soil where the lines can be cut into the softer ground and again different sharp blades can be used, but also wands, pointed stakes or even bones are suitable for such ripping into the earth.

Painting is most often done on a stretched-out cloth, carpet or directly upon the floor of the temple area and different kinds of consecrated pigments, tinctures and infusions can be employed in order to create a magical paint and thus further align the Work to the vibrations of those that it is intended to summon.

Marking is similar to painting with the difference that most often consecrated chalk or piece of charcoal is used to the trace the signs upon a suitable surface and the creation and consecration of such chalk have much in common with the methods employed for the consecration of the powders used for the strewing methods, during which a blend of elements from the plant, mineral and animal kingdoms considered in sympathy with the forces the powder is to connect to are unified, grinded up, made into a fine powder and consecrated

either upon the Qayinite Green Point of the Skull or upon the seal of the Kingdom, Qlipha or Spirit which it is to be dedicated to and become enspirited by. When ready this powder is used for the tracing out of the lines of the Hendecagram by carefully being strewed from point to point.

The painting method lends itself also to the work of Magical Inks created and employed when smaller sized Hendecagrams and related seals are to be drawn on sheets of consecrated paper or parchment; this is especially the case during talismanic workings in which these symbols need to be employed in a way that allows them to become Portable Points of Manifestation carried upon one's person, or employed in any other similar manner. When making magical inks the powder consisting of the enlinking and empowering elements must first be tinctured and by the addition of the drops of such tincture to the exorcised ink it receives all of the virtues of the elements that the powder consisted of.

The tracing of the lines by the way of smoke is most often done by the swinging of the thurible, within which is burnt the incense formula of the corresponding Kingdom or the general Qliphoth Incense suitable for all workings aiming at the opening of the pathways between the two sides, allowing the intrusion of the holiness of the Other Side into this side of the void. When for example working with the forces of Golachab also the smoke of a large cigar can be used for the magical tracing and quickening of the lines already marked out and in such case the glowing tip of the cigar is placed into the mouth and smoke is instead blown out from the cut head end of the cigar.

When employing combustion and fire most often the lines of the star are traced into the ground and then retraced with gunpowder, into which a small amount of one's own blood or that of a sacrifice can be mixed in beforehand, and ignited or as for the less combustive and more fiery alternative the cut Hendecagram can be given some strongly flammable libation offering poured out into its lines which then is set on flames,

with the ignition point always being that of its activation.

Such trenches cut into the soil can also be watered with the fresh blood of a suitable sacrifice, often mixed with red wine or other libation offering, in order to direct the harvested life-force and soul and cause its elevation and apotheosis by letting it become as one with the powers it is so channelled to manifest.

There are also many other ways in which the mentioned methods can be merged or expanded upon, in order to, in combination with the chanted Formulae of Calling relevant to the focused Point of Reflection, the fumigations, burning of candles, the performance of the correct rites and employment of tools and the astral and mental attention and focus demanded, open up the Pathways to the Central Gate at the Heart of the Hendecagram in order to give way for the power of the one/s called upon.

The most common form of maintaining the open pathway created through these stars is the 'Setting of Flames', connecting again to the ways of fire, which in the simplest forms involves the use of cleansed, dedicated, inscribed, anointed and consecrated candle or candles, placed upon one or all points of the activated Hendecagram, in order to keep the cracks created between the two sides of the Tehiru ajar and ready for that which is to be channelled or otherwise made to intrude through them.

The skilful employment of the Throne Seals and their Angle Keys can also strongly enhance all such openings of the Points of the Eleven and not only can the Throne Seal be placed at the centre of the Hendecagram in order to seat the manifesting essence, but also the Angle Key Seal can be employed as a marking, both by being inscribed on the candle and by being traced, connected to and, in a manner similar to how the star itself is traced, with the point at the nadir of the vertical central line of the Angle Key Seal, marked upon and within the corresponding Reflection Point of the Hendecagram before

its lines are established, thus further strengthening the focus upon the specific Spirit-Current of the deific aspect of the Elevenfold Light called upon, making firmer its anchoring within the side in which it is to unnaturally take form.

In those more usual cases when the Eleven Rulers themselves are not invoked or evoked, as direct contact with such elevated aspects is not something to be taken lightly or accomplished easily and without dangers, and instead other Qliphothic forces are sought and attempted to be made manifest the Governing Point of the Eleven ruling that Emissary, Qliphothic Order, Individual Daemon of Letter or any other aspect of the Other Side must still be activated in one of the mentioned ways and while the Angle Key Seal of the specific Governing Head of Azerate still can be employed upon the corresponding point and for example be inscribed on its candle the Hendecagonal centre/heart of the star itself is to be reserved for the seal, the elements and/or the Kelim-Vessel of Manifestation belonging to the one called upon.

Within such context the gates are first opened through and in the name of the Governing Head ruling the aspect with which contact is sought and from there the focus becomes shifted to the summoning of the specific Spirit-Current at the centre of the star.

When it comes to the actual tracing of the lines of the Hendecagram some kind of practical aid is usually needed in order to get each of the lines as straight as possible, most common approach being the use of a flat wooden measuring stick or a length of cord with which the lines can be marked out and drawn in a precise manner. As for the calculating of the correct spacing between the Eleven Primal Seed Points of the Hendecagram common knowledge concerning geometry and a sufficient amount of intelligence should suffice for the correct computation, as such aspects concern only practicalities and do not need to be approached esoterically.

The Egressive/Ingressive Hendecagrams

In the ways and aspects already described the Hendecagrams are connected to the coming into being of the forces of anti-existence on the Other Side, and while the First Mover and Movement of the Qliphoth is expressed through a Twofold Point within the context of the configuration of the Hendecagram such Dual Point of manifestation is formed by the apex and zenith point, being that of Satan, and the secondary point, belonging to Molok, to which it connects. The place of Satan's point remains fixed throughout all of the described forms of the Hendecagram, but that of Molok and all other succeeding Heads of Azerate become shifted according to the reflective aspect of the establishment of the lines/Rays of Black Light manifesting the Atziluthic, Briahic, Yetzirahic and Assiahic aspects.

The constant point, being that of Entering Into Being on the Other Side, signifying the point of manifestation from the Anti-Existence of Thoughtless Divinity, which before that point had veiled itself in the shrouds of Tohu, Bohu and Chasek, is esoterically a Point of Satan which in the absolute primal aspect also can be ascribed to Ama Lilith in her most elevated essential form, as all other aspects of the Eleven were in Unmanifest Form within its pregnant nothingness and born/reflected forth in an equal measure through it. But even with that being the case within the practical context Ama Lilith becomes manifest fully first through the tenth point, before the manifestation of Nahemah via the eleventh reconnecting to the first and establishing thus the Hendecagram.

What all this indicates is that That Point of the Eleven Star is a point of ingress into the Elevenfold Matrix of the Sitra Achra which leads us to the inverted forms of the Hendecagrams already mentioned, placing that once zenith point within the nadir closest to and pointing towards the one that would trace it, leading the person into the aspect which the Hendecagram encompasses by entering into Qliphothic Existence in a way mimicking that of the first

manifestation of the Thoughtless Light reflected as the Elevenfold Qliphoth.

Such Inverted Hendecagram is in actuality nothing more than any of all the other forms of the Eleven Pointed Stars, traced from the perspective of the ones coming into existence through it, and is thus a gateway not from but into the Qliphoth. These are therefore named the Egressive or Ingressive Hendecagrams, because through them the state outside of the Qliphoth is exited and via such an egress the Other Side, being the World of the Qliphoth, is entered into.

These Hendecagrams are therefore more mysterious in their application, especially when it comes to the ones connected to the two more transcendent worlds and their deeper applications are therefore something that is reserved for those that through the Invocative/Evocative Hendecagrams can reach for and attain the gnosis granted directly by the Spirits of Thoughtless Divinity and is not something that can be fully divulged by man. The only hints that can be given and which have already been given are that through these Egressive Hendecagrams life-force, soul, mind and Spirit can be projected into the Qliphothic existence and the simplest description of the aim of the workings that can be conducted through them is that of the transference of the aspects of Thoughtless Self/the Black Flame or the projecting of the essences of certain offerings through their reflective points, lines, angles and gates which they can open up in order to empower the Side of Qliphoth.

The most elevated Work that can be accomplished via such Points of Ingress towards the Other Side is through the Pan-Qliphothic aspect of the Hendecagram, as through such concealed approach Spirit can become as One with Azerate, but such thoughts must be reserved for the stage within the Qliphothic Work when all thoughts have been conquered and eliminated and nought but She-Ain Bo Machshavah remains.

The Egressive/Ingressive Hendecagram of
Atziluth

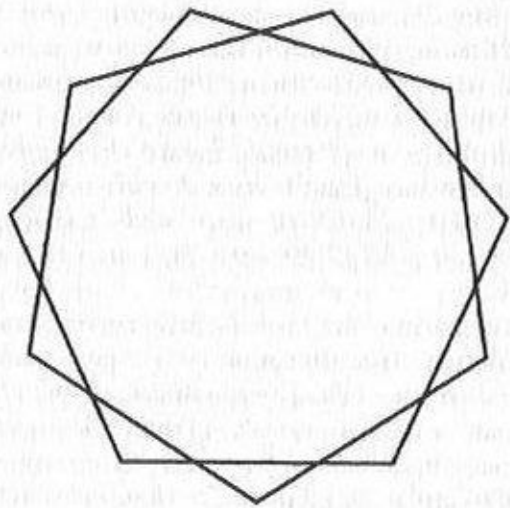

The Egressive/Ingressive Hendecagram of
Binah

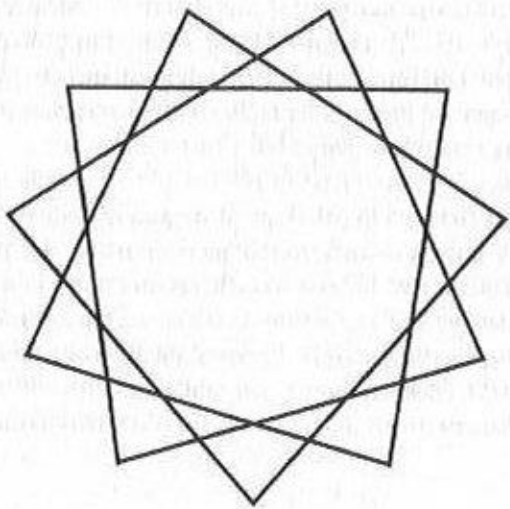

The Egressive/Ingressive Hendecagram of
Yetzirah

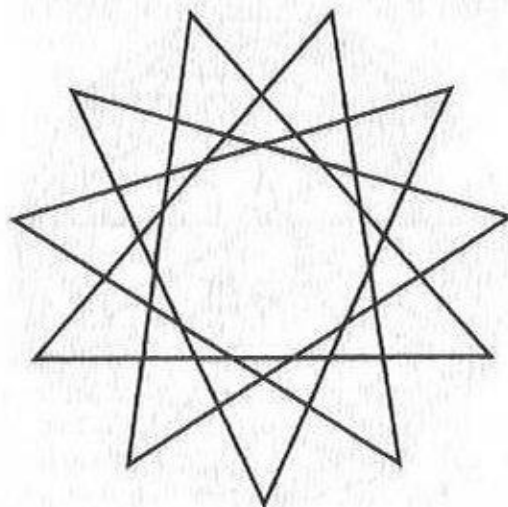

The Egressive/Ingressive Hendecagram of
Assiah

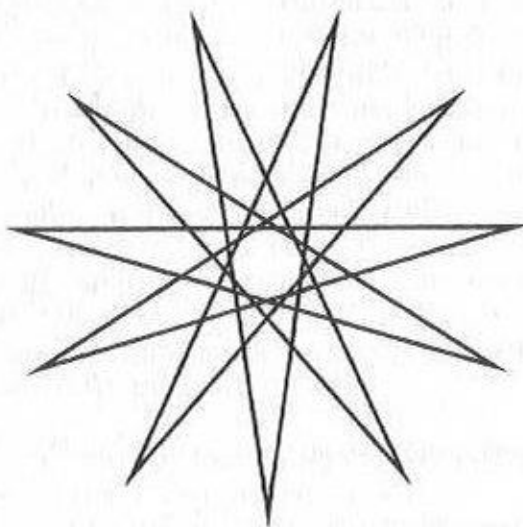

The Egressive/Ingressive Pan-Qliphothic
Hendecagram of Azecate

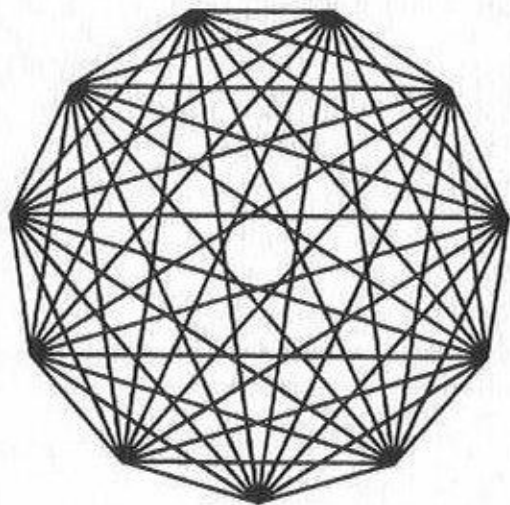

Building Blocks of a Qliphothic
Temple =
The Tools of Praxis

Some of the workings aimed at the establishment of contact with the forces of the Other Side are best conducted outdoors, in places desolate, wild and liminal in nature, as through such points, acting as cracks in the covering of perceived reality, the Other Side of the Tehiru can easiest be made to intrude into this Sephirothic side. Such places must be chosen very carefully and be far removed from populated areas so that one's work does not become disturbed by the profane children of Adam and desecrated or prosecuted because of their lack of respect and comprehension for all that which transcends their own clay-born ignorance, fears and enslaving laws.

Such outdoor points must also be chosen with consideration for the *genii locorum* inhabiting them and before all workings proper offerings must be presented to the guardians and owners of all such places in order to make them as allies in one's undertakings, enticing them to act as one's wards granting protection against any disturbing influences, but in the cases when they instead would be of such nature that they would not accept a friendly treaty offered they are to be exorcised harshly and kept out by the way of banishing fumigations, the setting up of magical borders and the calling upon the forces that with the Fires of the Seven Kingdoms of Qliphoth would cleanse such place and consume any offending shades, elementals or Spirits.

Even if the outdoor setting is the optimal choice for many of the workings and actually the only option when it comes to a select few of them, like for example those demanding the

more extensive employment of combusting elements, blazing fires or venomous fumigations it will remain so that the most practical and safe approach to the Qliphothic Work will often be through the establishment of an indoors temple or altar room, a place where the work can be conducted without the fear for random disturbances caused by outsiders and in which the sacred tools of the Qliphothic Cultivation can be kept both in a safeguarded and worthy manner.

Such indoor temple can be grand or simple and plain and as long as it can offer room for the work that needs to be conducted therein and has space enough for all of the tools, weapons, talismans and fetishes that will become accumulated during the life-long dedication to the Great Work it will suffice. An intelligent approach towards practicalities, such as how to best trace and activate the different Hendecagrams and Seals within such indoors location will also yield the best result and one must adapt to the limits of the environment within which the praxis is to be conducted. The use of stretched out pieces of cloths or suitable carpets to place upon the floor before the tracing of any signs is usually the most practical approach, as such marked fabrics after the conclusion of the work can just be rolled up and tied with a piece of cord and saved for the next time such signs are needed, during which their markings must be retraced, ritually quickened and reactivated.

Within the indoor temple often an altar is raised in order to aid in the cultivation of and strengthen the focus placed upon the forces with which one seeks spiritual communion and union. Such altar is considered as an Earthly Throne and Gate of the Eleven and must be treated as such after its proper cleansing, marking and instalment. We will now shortly touch upon some of the details concerning the altar and some of the other implements of the Qliphothic Temple in order to make known the tools that in the correct hands will act as the keys opening up the mysteries concealed within this Grimoire of the Dragons of the Other Side.

The Altar-Throne

The altar should be made of a square wooden table measuring at least 80cm in both width and length. It is important that the top of this table is not lacquered and left plain so that it is possible to draw upon it with for example consecrated chalk when it later is to be employed within the ritual work.

This table must be cleansed ritually and dedicated to the Work via a twofold fumigation process before being marked and permanently installed as the Throne Gate to the Other Side.

The first step of fumigation employs a simple mixture of Rue with just a pinch of sulphur mixed into it and by the smoke of this mixture smouldering underneath the table all profane and unwanted attachments are banished, in order to leave a void and clean space.

The second part of the fumigation employs a Dedication Incense Blend connecting to the Seven Kingdoms that in different ways are to have their powers seated and manifested through the Altar-Throne and consist of an equal blend of the following elements:

- 1 part Myrrh
- 1 part Black Copal
- 1 part Dragon's Blood
- 1 part Frankincense
- 1 part Red Sandalwood
- 1 part Mace
- 1 part Mugwort

This blend is to be burnt again underneath the table while the following Formula of Dedication establishing connection to the Other Side is chanted in its entirety eleven times, with incense being added to the brazier for each round of its recitation:

*Samotheshel * Beogshel * Lurossashel * Asgaabel * Asgotiel
* Bethabael * Baortzel * Adsashael * Ligaghel *
Nanaghel * Azeratel (x11)*

After this dedication to the forces of the Other Side the altar table is ready to be permanently marked, this being done either by some suitable and consecrated paint or more ideally by being branded with a pyrography tool.

The main and essential marking upon the Altar throne is simply the Eleven Primal Seed Points through which all forms of the Hendecagram can be established and also the Hendecagon be created. These points of reflection are to take the main and central space on the table and be as wide in circumference as possible.

From these Eleven Points any form of the Hendecagram can be traced physically, like for example with the mentioned chalk, but also with charcoal, different powders and even blood or just by the Fires of Imagination and Spirit, making the lines so established take form on the more subtle levels of existence, visible only to the Eye of Spirit.

This method allows also for the removing of all such signs after they have served their purpose, which is something most often done with the aid of a suitable libation offering poured upon the surface of the altar which then is wiped off with a piece of clean and cleansed cloth. This method allows for a very multifaceted employment of the altar, allowing it to function via the different forms of the Hendecagram as a direct link to all of the Four Qliphothic Worlds of Atziluth, Briah, Yetzirah and Assiah.

Another practical aspect of the Altar Throne is that it is even possible to turn it around whenever the employment of the Egressive/Ingressive Hendecagrams would be needed and it can thus give the foundation for the establishment of the Inverted Stars of the Eleven.

Whenever possible the Altar-Throne should be positioned against the northern wall of the temple, as the North is within the context of Qabbalistic magic perceived to be the point of intrusion for the forces of Sitra Achra.

Through the properly erected and consecrated altar vesting the emanations of the Other Side with a Point of Manifestation on this side furthering their cause of Liberating Usurpation one's own path of transcending towards and Enthronement within the World of Qliphoth becomes opened and its traversing initiated, as all unfated increase of the influences of the Thoughtless Emanations will hasten the Return of All back to Ain via the Tree of Death which by the tip of its Highest Crown remains attached to the Unmanifest Holiness of the Fullness of Emptiness.

Candle Holders

Upon the altar there should be eleven candle holders, made of brass or any other suitable metal, and each of these candleholders must be permanently marked with the Angle Key Seal of one of the Eleven Heads of Azerate in a clear manner that starkly shows to whom each holder belongs.

These candle holders are to be shifted in position upon the Eleven Seed Points of the Altar, according to need and depending on which working is being conducted and will thus act as the Keys of Fire opening up the points of the Hendecagrams being established upon the altar during the ceremonial proceedings.

Each candle holder is to be given its own black candle, that has first been cleansed by the smoke of burning sulphur and then inscribed with the Qliphothic Formula of Calling of the Head of Azerate to which it is to be connected to, plus the Angle Key Seal, which is to be inscribed close to the base of the candle. It is possible to further bless such inscribed candles with anointment employing either the correctly corresponding oleum, the blood of the operator himself given in a solemn oath of alliance and loyalty to each of the Eleven, or by that of slain sacrifices given to each corresponding Ruler.

These candle holders can also, when need be, be removed from the altar and for example placed upon similar Eleven Seed Points of the Hendecagram when and if they for example are traced upon the floor or the ground and become as such literally the Keys of the Eleven, with their flames unlocking the Angles of the Gates to Sitra Achra.

Only by the possession of the Inner Fire of Thoughtless Spirit the eleven candles lit for the Heads of Azerate can be given Flames of Black, connecting directly to and reflecting the Light of the Other Side, illuminating those that are of their own cause and banishing the White Darkness that would otherwise seek to blind the Spirit.

The Kelim-Vessel of Manifestation

At the centre of the altar Hendecagram, or the ones traced upon the ground, most often a Kelim-Vessel is placed during the rites of invocation or evocation. These vessels are in most cases simple unglazed terracotta bowls, marked inside and out with the seals and signs of the Spirit they are meant to act as the Vessel of Manifestation for.

Most often the main seal of the one called upon is inscribed inside of the bowl with the aid of a stylus, and different Formulae of Calling and Names of Power corresponding with and strengthening the Spirit called upon are inscribed on the outside of the bowl.

For example in the case of the Eleven Rulers the Throne Seal is inscribed inside of the Kelim, while their Angle Key Seals and Qliphothic Formula are traced on the outside of the vessel.

Similarly can individual Kelims be created for each of the 10 Qliphothic Orders, by having the seal of the Qlipha inscribed inside of the bowl, the Throne Seal of the ruler underneath it and the seals of all its Emissaries, together with its Formula of Calling, on the outside of the bowl.

There is also the possibility for making a Pan-Qliphothic Kelim of Azerate by the employment of the corresponding Hendecagram reflecting 11 through 11 within the vessel, this in combination with the inscription of all eleven Angle Key Seals on its outside, together with the relevant Formula of Calling evoking the full force of the Eleven.

In certain settings it is possible to for example mark the Kelim-Vessel in a less permanent manner also, like for example with the aid of chalk, charcoal or ink, depending on the exact nature of the ritual.

These vessels after having been prepared carefully are positioned at the centre of the Hendecagram being employed and receive during the rituals the blood of the slain offerings given to fortify the manifestation of the Spirit called upon and will within the Kelim bind the life-force of the sacrifice to cause the manifestation needed through the seal it washes over and the ajar Gate of the Star of Thoughtless Light it stands upon and within.

Such vessels of manifestation can with time evolve into Kelim-Fetishes proper, holding not only the seals and the blood offered each time it is activated, but also other elements that can further connect to and strengthen the manifestation of the Spirit it represents. These additional elements are as usual harvested from the plant, mineral and animal kingdoms and serve in unison to echo a sympathetic call to the force they are meant to cause enlinkment to and constitute as a Physical Point of Manifestation for.

Within some of such fetishistic workings, aimed at the creation of permanently open and activated points of manifestation related to the Eleven Heads there is also an alternative approach to the employment of the Angle Key Seals. Within these special settings the Kelim Vessels, which in these cases also can take shape as cauldrons, are cleansed, dedicated and inscribed in the usual manner but as an addition the Angle Key Seals are forged and formed in Iron, in a way that allows them to stand erect in a stabile fashion within the Kelim and as a physical key to be turned upon the seal inside of the vessel, acting also as a kind of antenna fine-tuning both the Spirit Currents the operator seeks to make manifest and those that he seeks to project to the Other Side, for example via the different sacrifices given.

When such kelims are worked, imbued with the essence of the Other Side and filled with all the other enlinking elements which serve to stabilise the manifestation of Qliphothic forces the true Kelim-Fetishes will have been created, serving as living and open points of focus for the Forces of Qliphoth to

manifest themselves through into this side of the Tehiru, expanding in power until the Kelim is Shattered and the forces made so to manifest are set loose to act according to their own Sacred At-Azothic Cause.

Here are many mysteries placed within the reach of the cunning to decipher, put to practice and attain fulfilment through, as the work of the Kelim-Vessels reflect in a most intimate manner the alchemical process of the internalisation of the Light of Divinity, aimed at the expansion and empowerment of Spirit, until no vessels can contain its Black Fire setting the world aflame and returning triumphant back to its Source.

The Mirror Gates and Scrying Bowls

Many are the mirrors employed within the practice of Qliphothic Sorcery as it is believed that via reflections one can reach out to the reflective world of the Thoughtless Antithesis mirroring everything it seeks to dissolve, but the truth of the matter is of course more complicated than that, even though Jewish folklore for example contains many cautionary tales about the misuse and dangers of ordinary mirrors, such as the tales about maidens being snatched away by Lilith because they spent too much time in front of the mirror in vain self-adoration or those of the dead becoming trapped within the reflective glass because the mirrors were not covered for seven days and night after someone had died in the house.

These simple stories points to an atavistic and instinctive knowledge that can be found, in one form or another, all around the world concerning the powers of mirrors and their potential to act as Gates for Spirits and as a window to, or a prison for, the souls which can be seen through or caught within them.

The mirrors employed within the context of the Qliphothic operations can take many different forms and some of them are not even made of glass, as Mirror Gates can also effectively be created by filling the Kelim-Vessels of Manifestation empty of all but their inscribed and bloodied seals with water to which drops of magical oils and tinctures possessing the power to aid in the attainment of the Second Sight are added, such as those containing the essences of Belladonna, Eyebright, Star Anise, Acacia, Mandrake, Tobacco, Wormwood and Mugwort, this in order to turn the Kelim into a potent Scrying Bowl serving a similar purpose as the more usual mirrors, but within this context gazed into in order to receive visions from the specific power to which the vessel belongs.

When it comes to the creation of the more traditional Mirror Gates we gave in the chapter about the Seven Hells hints about the creation of such mirrors belonging and acting as a gate to each of the Seven Kingdoms of the Other Side. Through similar approach one can also create other Mirror Gates of black framed glass, on the back of which the consecrated and activated seals drawn on paper or parchment can be added in order to prepare the mirror to via proper consecration at the centre of the Yetzirahic Hendecagram become connected to the astral realm of the Qliphothic force to which the mirror is to be connected.

If the Seven Hells Mirrors are not specific enough one can make a Mirror Gate for each Qlipha so that they have their own specific mirror through which their Governing Head, Emissaries and all members of their Qliphothic Order can be reached.

Such mirrors when placed within the correct Hendecagram and/or the properly activated seal belonging to the force from which visions are sought, will act as the most miraculous tools for the full awakening of the astral senses and the opening of the Eye of Spirit.

The Sacrificial Knife

The knife employed within the Qliphothic operations must be able to serve its practical function, which is to cut, and must as such be of great quality and as sharp as possible. This knife is ideally black-hilted and dagger-bladed, as the dual-sided blade enlinks itself finely to the Dual-Natured Essence of the forces it is to serve.

The knife is to be acquired in the day and hour of Mars and be consecrated during the night ruled by the same planetary influences, but in the later night hour of Venus.

The consecration of the knife should mimic that of the work of the blacksmith accomplished by heating the blade in each of the Flames of the Eleven, while calling upon them individually to bless the blade and then quenching it in a mixture of red wine, aconite tincture, 7 drops of the attar of Rose and the drops of freshly spilt blood of the first sacrifice made by that blade, being that of the operator himself, drawn from the left hand.

When this heating and quenching of the blade has been repeated 11 times it is time to first wipe it with a cleansed piece of cloth and then inscribe or otherwise permanently mark it on both sides.

On one side the blade is to be marked with the seal of Balael, the Fifth Emissary of the Qlipha of Asmoday, with conjurations and supplications directed to him in the name of his Governing Head, asking him to bless, imbue and connect the knife to his own essence for the sake of the accomplishment of the Great Work of the Thoughtless Cause and then on the opposite side of the blade the same procedure is repeated but now with the seal of Zabachel, the Fourth Emissary of Oreb Zaraq, adjuring him to enlink the blade permanently to his own essence, in the name of Baalbaalatzelmoth.

On the Side of the Blade dedicated and bound to Zabachel also the following Qliphothic AGLA is then inscribed or otherwise permanently marked in order to direct the essences of all sacrifices slain with it to Azerate:

אתה גבור לעולם אזראט

In similar manner the side of Balael is marked with the following inscription, binding that aspect of the knife to the destructive power of the Sword of Asmoday for the workings of harsh banishment or deadly bane:

הרב דאסמודאי

When the knife has been so marked and linked to the two Emissaries of Mars and Venus it is again to go through the heating and quenching process for a second time in order to seal the powers called upon fully within it, making it as an Enspirited Talisman, Tool and Weapon to be venerated and cherished, with the power to accomplish the work of both Emissaries to whom it has been made connected.

By this blade not only are the Offerings to the Other Side given in a manner that does not allow for the misdirection of the sacrificed essence but it also possesses the power to vanquish unwelcome forces and to conquer and in more ways than one aid in the elimination of one's foes.

This knife, when not in use, is to be wrapped up in a piece of red silk and kept on the left side of the altar.

Such Sacrificial Blade of the Thoughtless grants victory to the Children of the Serpents and cuts off the offending hands of those others that would seek to profane it by their desecrating touch and impure approach towards its Holy Spirit of Conquest and Sacred Martyrising Cause.

The Twisting and the Straight Wand

Two forms of wands are employed within the Qliphothic Work, each serving different functions and embodying different aspects of the Dragons of the Other Side, aiding in a most practical manner in the channelling and directing of the forces with which the Thoughtless Adept seeks to interact.

One wand is coiled, twisted and crooked and belongs to the ophite aspect Lilith, while the other one is the straight or slant one and belongs to her mate Samael, being in this case a serpentine manifestation of the Spirit of Satan.

Nachash Akalaton

נחש עקלתון

The coiled and crooked/tortuous wand of Lilith is the Nachash Akalaton Wand, representing the coiled serpent spiralling downwards or twisting itself around that which she is to establish her powers within, constrict or afflict with her venom. This is a receptive wand, encircling and gathering in power and is as such often a tool of invocation. This wand is to be either harvested or consecrated during the night of the Black Moon, during the late night hour of the same planet. The wood of this wand must come from a tree possessing a spirit in sympathy with the feminine and lunar nature of Lilith and the Spirit of the tree must according to the Qayinite praxis be re-called and made to serve as handmaiden of the Queen of Sitra Achra.

During the consecration of this wand the name Nachash Akalaton is to be written or branded upon it in Hebrew letters, from the handle towards the tip, followed by the Angle Key Seal of Lilith, pointing with its horned crescent towards the tip of the wand. For the optimal sealing of the power of this wand a female snake should be worshipfully offered up as sacrifice to the Tortuous Mother of Serpents and its blood used to anoint the whole of the wand, from tip to handle,

while Lilith's Qliphothic Formula is chanted 11 times and she is asked to fully bless the twisting wand so that it can aid in the accomplishment of the Great Work.

During this work the operator should also taste drops of the blood spilt as a holy sacrament and give praise to the martyred snake that now has become elevated by being offered up to Lilith.

If the skin of the snake can be removed and properly cured it can at a later time be used in parts to adorn or even wholly cover the wand, depending on the size of the snake so employed as the sacred offering.

This wand should be wrapped up in black silk when not in use and kept upon the left side of the altar.

Nachash Bariach

נחש ברה

The second form of the wand is that of Samael in the guise of Nachash Bariach, the straight and piercing serpent, ascending with dominion from tail to head and from the nadir to the zenith, penetrative in power and intruding like a sword thrusting through the heart and the soul. This is a projective wand, for the sending forth of power and a tool of evocation, causing of unfated changes in accordance with the power of Unbound Will and Spirit it directs outwards.

This wand is to be harvested or consecrated during the night of Mercury with the Moon in waning phase during the planetary hour of Mars. The wood of this wand must come from a tree possessing a Masculine Force related to the Serpentine Power and its Spirit must be quickened and bound to the service of the Work of Devil. There are a few easy to find options when it comes to the selection of such wood, which is something that those contemplating the workings in this Grimoire should already have familiarity with and they shall therefore remain unnamed, but a more rare but also

perfectly suited option for this wand would be a straight branch, or suitable piece of wood to carve out such a wand from, harvested from the Black Ironwood tree, being a tree with strong links to the Liminal Point leading to Sitra Achra.

During the consecration ritual the name Nachash Bariach is to be written or branded upon it in Hebrew letters, from the handle towards the tip, followed by the Angle Key Seal of Satan, pointing with its arrowhead towards the tip of the wand. The consecration of also this wand is to be sealed by the sacrifice of a snake, this time a male, and the blood is to be employed in the same manner as during the consecration of the wand of Lilith with the only difference being that it this time is smeared from the handle out towards the tip of the wand, while the Qliphothic Formula/Invocation of Satan is chanted 11 times and he is beseeched to bless his piercing wand of projective power.

Also this wand can be adorned with the skin of the snake if possible and in either case wrapped up in black silk and kept at the left side of the altar when not in use.

If any of these wands would be forked as the Serpent's Tongue at the tip it is believed to be very auspicious and doubly powerful as it in such case represents better the dual nature of the Qliphoth, manifesting so the powers of Two-Headed Nachash within its one single form, creating thus a fuller enlinkment to the Holy Cunning Serpent from and back towards whom our Fiery Bloodline courses.

The Chalice

The chalice or cup serves as the Grail of the Dragon and is the vessel from which sacraments are partaken of and potions and philtre composed within. It is ideally made of silver or silver plated, as it is primary linked to the sphere of Gamaliel and to the Goddess Lilith, acting as her Wanton Womb, emitting from the Other Side the Venomous Nectar of the Serpent received through the Work of the Chalice, possessing the power of setting the Spirit aflame, awakening it from its slumber binding it to the cosmic darkness of Thoughtful Light.

The chalice not only serves as a drinking vessel through which libations can be served and partaken of, but also as the vessel for the scrying of the waters of the moon, when filled with suitable liquids and gazed into under light or darkness of the moon, giving way to the shapes and forms projected from the subtle worlds towards manifestation.

The chalice is also the receptacle of blood, being the water of life, and is as such a container of life-force and other subtle energies manipulated during the different operations and is in similarity to the Mirrors of the Art also an astral gateway through which the realms of dreams and nightmare can be penetrated and manipulated.

The consecration of the Chalice is simple and initiated first by the cleansing of the chalice. This is done by the washing of the chalice with an infusion of Rue to which sea salt has been added. After having been rinsed the chalice is dried over the smoke of Mugwort, Tarragon and Jasmine, while the Qliphothic Formula of Lilith is chanted eleven times. The inner part of the Throne Seal of Lilith is at this point inscribed or otherwise permanently marked upon the chalice and the Lady of the Blood-Chalice is adjured to bless and link it to herself.

The chalice is then to be filled with a suitable libation offering, Lilith's formula is once again chanted eleven times over and into the chalice and its contents are then partaken of in the name of the Goddess of the Qliphothic Moon, in order to let that which is consumed befall her so that she in return grant her blessings and open wide the Womb-Gate to the Other Side that the chalice now constitutes and in one aspect represents.

The Chalice when not in use is to be kept on the right side of the altar, wrapped in a piece of red silk.

The Bell

The bell is an instrument of Wordless Invocation ringing with the Soundless Void between its chiming out to the ears of the Spirits it is calling out to and is as such a tool dedicated to the Lord of the Screaming Silence, Beelzebub.

The bell can be of any size and form but is ideally made of brass and has a handle. Such bell is to be cleansed with smoke of burnt Rue and then inscribed or otherwise permanently marked on one side with the Angle Key Seal of Beelzebub and on the other side with the seal of Acharel, the Fifth Emissary of Aogiel.

The bell is then consecrated with the smoke of a cigar, through which the Qliphothic Formula of Beelzebub is projected into it eleven times in between the chiming of the bell held in left hand, so that it receives the smoke each time that its ringing sound dies out, thus charging it within the moments of silence. The same process is then repeated with focus this time on the side marked with the seal of Acharel and instead of the formula this time only the name of this Emissary is projected into the silencing bell via the exhaled smoke of the tobacco.

Lord Beelzebub is adjured to conjure the bell with his waves of Crushing Alogos storming forth to eradicate the Word of the Creator and to grant the bell bearing the Key to his Throne the power to ring out in silence to call upon all those forces of Sitra Achra stationed beneath his own Seat of Power. Next the Grand Emissary Acharel is conjured to grant his powers through the bell, so that it does not only call upon the forces with which contact is sought but also forcefully banishes unwanted influences in order to create a cleansed ritual space whenever the bell is chimed in his name.

The bell is at that point chimed 11x11 times and a deep meditation is commenced with the intention to enter the Screaming Silence Betwixt All Sounds and reach for the Thoughtless Void In-Between.

After this concluding meditation the bell will be attuned to its cause and fully consecrated.

The bell when not in use is to be kept on the right side of the altar.

The Brazier, the Thurible and the Incense of the Alt

The work of the brazier and the thurible are of outmost importance when it comes to the Qliphothic operations, as it is with the power of burnt offering, following the first approach of Master Qayin towards sacrifice, and the aid of the Spirits of the Black In Green that we can achieve many things otherwise impossible. Through the giving of the correct smokes during the ritual workings the whole vibratory foundation of the temple area is manipulated and made to align with the subtle pathways through which desired result is sought to be made manifest.

There are different approaches towards this magic, but all of them should be from the perspective of one that can see the Spirits hiding behind the guises of the plant kingdom and also understand how to combine, awaken and direct their forces towards desired end, being within the context of this text the aiding of the coming forth of the Currents of the Other Side via the opening of their different gates, whether they be linear such as their seals or otherwise established in other forms.

The science of the incense making must first be based on Tradition in order for it to later on move into the area of Personal Gnosis, where the correspondences of older sources may become less important than the blends and formulae which the Famuli and Spirit Wardens of the Current worked with and within inspire one to create. Above all it is the attained results which give value to any mixture employed within the context of the Qliphothic operations and if one formula does not suit the work of an individual the person in question must study, pray, sacrifice and experiment in order to reach for and attain new ones hopefully more in harmony with the personal abilities and spiritual senses and thus better become directed to open up the Pathways of Fire and Smoke, granting wings to the Divine Sparks caught within the corpses of the plants, so that they may rise up as messengers to serve the cause of one's magic, being the Thoughtless Cause of the Other Side.

The brazier within our work is to serve as the stationary and fixed point for the burning of offerings and is as such an instrument for the erecting of the Smoke-Pillar of Manifestation, while the thurible on the other hand is a more dynamic and movable incense burner, hung on chains, making it possible to swing freely and thus direct its smoke more specifically towards any area or cardinal point during the circumambulations for the quickening of the different points of manifestation established within the ritual space. In skilled hands the thurible can even serve as a quill of fire and smoke with which the seals of Spirits and those of the Seven Kingdoms can be traced and activated in the air and on the subtle planes penetrated via the vibratory alteration caused by the Spiritual Current rising within, through and because of the smoke.

The brazier and thurible are connected to a few different Qliphothic Rulers within our work, the primary one being Lord Asmoday, the Head of the Burners With Fire, but these tools hold also secondary connection to Beelzebub because of their ascriptions related to the Smoke of the Air of Fire and on the highest level also to Molok, being the holder of the most elevated mysteries of Sacrifice Through Flames.

These tools must before their proper consecration first be taken out to a suitable outdoors location and there be cleansed by the smoke of a mixture of Rue and Sulphur. The brazier is then to be inscribed or otherwise permanently marked with the seal of Charchurel, the Fourth Emissary of Golachab and the thurible with the seal of Ophiseshel, being the Second Emissary of the same Qlipha.

A sacred pyre is then lit in the name of Asmoday, his Qliphothic formula chanted 11 times before a suitable sacrifice is given to him by the way of the knife. The blood of the offering so slain is to be spattered over and into both the brazier and the thurible while the formula of Asmoday again is chanted 11 times.

The remains of the offering are given to the flames of the pyre and the brazier and thurible are then in turn passed 11 times each through the fires consuming the sacrifice with the name of their corresponding Emissary called out to for each passing through the flames. After the eleventh passing the corresponding Emissary is to be conjured and adjured in the name of Lord Asmoday to bless the tool so enlinked to them via blood and the Fires of Sacrifice and to grant power so that the workings of the Burning With Fire through those sacred tools always become victoriously accomplished.

A small amount of the ashes of the sacrificial pyre is to be collected in the name of Asmoday and placed within both brazier and the thurible, to seed them fully with the enlinkments to their governing Head of Azerate.

These tools for the giving of burnt sacrifice are to be kept on the left side of the altar when not in use.

The consecration of each herbal formula burnt within the brazier or the thurible should be accomplished by the basing and placing of the incense components either upon the Qayinite Green Point of the Skull or upon a corresponding Qliphothic Point of Manifestation for the sake of the awakening of the related Spirits of the Black In Green and the enlinkment to the forces the incense is to connect to and aid to manifest on this side of the Tehiru. Each blend after its proper consecration and quickening is thus to be correctly considered an Enspirited Talisman in its own right, becoming fully activated when burnt and its powers liberated by fire in order to cause effect according to purpose.

The following are a few formulae sufficient enough for the initial workings which will open the gates and lead the student of this Book of Sitra Achra to the deeper aspects of these and other related mysteries. Those who would seek to penetrate the secrets connecting the Spirits of the plant kingdom to the forces of the Other Sides should consult the Falxifer Books, as by the grace of Master Qayin and His Bride all

such secrets can be unveiled, as it was Qayin who first gave the incense offering of burnt fruits of the earth, which was rejected by YHVH but accepted by the forces of the HVHY chthonically linked to via their Liminal Intersecting Points of Nahemothic Insurrection.

Incense of Echad-Asarel:

(A blend suitable for all Qliphothic Workings)

- 2 parts Mandrake root powder
- 2 parts Angel's Trumpet flowers
- 2 parts Yew needles
- 2 parts Thorn Apple seeds
- 2 parts Black Ironwood wood powder
- 2 parts Walnut shell powder
- 3 parts Henbane leaves
- 3 parts Cypress needles
- 3 parts Fig leaves
- 3 parts Myrrh resin
- 4 parts Wormwood leaves

To this blend eleven drops of blood from the left hand's middle finger are added, each drop given in the name of and as a solemn oath of loyalty and devotion to the corresponding Head of the Eleven, with the first drop given in Satan's name and eleventh drop in Nahemah's. The blend is mixed and grinded properly with the aid of a mortar and pestle and the resulting powder is placed either on the Green Point of the Skull, if the operator be initiated in the Qayinite Mysteries in order to fully re-enspirit and consecrate it, or alternatively placed in the middle of the invoking Hendecagram of Assiah, which has its points activated correctly, with flame set upon each point while the corresponding Qliphothic Formula is chanted in order to make the flame of each candle burn black and thus call upon the powers of the Eleven to bless the incense blend and empower it with the enlinkment to the Echad-Asarel, being the Eleven of the Other God, so that when burnt it can through the elemental ladder make way for Their emanations and manifestations.

At this stage the Black Fire of the Other Side is beheld with the Spirit's Eye to rise within the heart of the Hendecagram, which is the Hendecagon at its centre, and via that fire the operator realises that the powers of Azerate are being installed and linked to and through the herbal mixture watered with blood and so that also the operator himself through the links of his blood is being empowered and linked to the Heads of the Other God.

When all candles have burnt down the incense is ready for use and can be kept in a suitable box, jar or other container until it is needed for the Qliphothic endeavours that it is intended for.

The following formulae for the Seven Gates of Hell or more correctly the Seven Kingdoms of Sitra Achra are most useful when it comes to the Work of Incense and if used correctly in connection to the rituals of the gates they can strongly aid in the unlocking of the Points of Power belonging to each of them and open them up to let in, or lead towards, their corresponding denizens and kingdoms.

Within these formulae also blood or other bodily elements from animals are added for the sake of the fortification of the exact direction of the power of each mixture and for the sake of the strengthening of the chains of sympathy causing enlinkment from this to the Other Side.

Mentioned within the list of animal elements befitted to lend empowerment to all of these formulae is the Snake, which because of the Ophiolatry of the Qliphothic Cult is given the most elevated position within the animal kingdom and can as such empower any ritual and any formula meant to connect to the Dragons and Serpents of Sitra Achra, during which the blood of a snake is sacrificed in the most worshipful manner, or when its blessed corpse-elements are in other ways employed.

When possible the animal chosen for the empowerment of the formula should be sacrificed over the herbal blend and its blood let to drop into it, this in order to allow the creation of a paste which then is formed into small pellets. These pellets are then left upon the altar to dry before use. When and if fresh blood is lacking, other elements from the animal or animals are in dried and powdered form added to the mixture before its consecration, as such elements will in lesser degree and on other levels cause similar enlinkments and empowerments as what the blood would have done and will so still bestow aspects of the soul and virtues of the animal to the formula, making it serve the cause of the manifestation of and connection to the forces it is dedicated to.

If blood is not used and the pellet form is still desired it is also possible to add a small amount of red wine into which drops of honey have been dissolved and in order to make such blends moistened in the described manner more combustible to suit certain specific workings one can also dissolve a modest amount of saltpetre within the wine before it is in a modest portion given as a libation offering to the Spirits of the elements the formula brings together and consists of.

The idea of the pellet form can alternatively be discarded altogether and one can in an equally effective manner employ each of the incense blends in their plain powder forms, as when sacrificed upon hot coals the final result will on the spiritual level be more or less the exact same.

What follows now are the Incense Formula of the Seven Gates of the Kingdoms of Qliphoth, called Hell by those who would consider the causal imprisonment of Spirit something paradisaal.

Sheol ha-Tehom Incense:

- 4 parts Myrrh resin
- 4 parts Frankincense
- 3 parts Cypress
- 3 parts Henbane
- 3 parts Cannabis leaves or seeds
- 3 parts Belladonna leaves
- 2 parts Poppy seeds
- 2 parts Devil's Trumpet seeds
- 2 parts Coffee beans
- 2 parts Galangal root
- 2 parts Pomegranate peels

Mix with the blood or powdered elements of goat, bat, black cat, vulture, flies, locust, bull, ox or snake. Place on the activated seal of Sheol ha-Tehom and call upon the powers of the First Supernal Kingdom to bless and imbue it with Their essence so that when burnt it can aid in the opening of the Seventh Gate.



Abaddon Incense:

- 4 parts Black Copal
- 4 parts Fig leaves
- 3 parts Cinquefoil
- 3 parts Galbanum resin
- 2 parts Horse Chestnut wood
- 2 parts Oak wood
- 2 parts Agrimony

Mix with the blood or powdered elements of stag, deer, swallow, lark, stork or snake. Place on the activated seal of Abaddon and call upon the powers of the Second Kingdom to bless and imbue it with Their essence so that when burnt it can aid in the opening of the Sixth Gate.

Tit ha-Yon Incense:

- 4 parts Dragon's Blood
- 3 parts Blackthorn leaves
- 3 parts Pine needles
- 3 parts Tobacco
- 1 part Aconite root
- A pinch of Sulphur

Mix with the blood or powdered elements of man, wolf, swine, woodpecker, scorpion or snake. Place on the activated seal of Tit ha-Yon and call upon the powers of the Third Kingdom to bless and imbue it with Their essence so that when burnt it can aid in the opening of the Fifth Gate.



Var Shachath Incense:

- 4 parts Frankincense
- 3 parts Olibanum
- 3 parts Bay Laurel leaves
- 3 parts Celandine
- 2 parts Cloves
- 1 part Saffron

Mix with the blood or powdered elements of ram, lion, rooster, pig, donkey, parrot or snake. Place on the activated seal of Tit ha-Yon and call upon the powers of the Fourth Kingdom to bless and imbue it with Their essence so that when burnt it can aid in the opening of the Fourth Gate.



Tzelmoth Incense:

- 4 parts Red Sandalwood
- 3 parts Angel's Trumpet flower
- 3 parts Red Rose petals
- 3 parts Mandrake root
- 2 parts Coriander seeds
- 2 parts Apple rind
- 2 parts Vervain

Mix with the blood or powdered elements of magpie, crow, raven, dove, horse, dog or snake. Place on the activated seal of Tzelmoth and call upon the powers of the Fifth Kingdom to bless and imbue it with Their essence so that when burnt it can aid in the opening of the Third Gate.



Shaarimoth Incense:

- 4 parts Fly Agaric Mushroom
- 4 parts Palo Santo wood
- 3 parts Tansy
- 3 parts Mandrake root
- 2 parts Aspen wood
- 2 parts Mace

Mix with the blood or powdered elements of a peacock, lizard, scorpion or snake. Place on the activated seal of Tzelmoth and call upon the powers of the Sixth Kingdom to bless and imbue it with Their essence so that when burnt it can aid in the opening of the Second Gate.



Gehinnom Incense:

- 4 parts Mugwort
- 4 parts Mandrake root
- 3 parts Jasmine
- 3 parts Patchouli
- 3 parts Parsley
- 2 parts Wormwood
- 2 parts Yew needles

Mix with the blood or powdered elements of woman, frog, toad, owl, bat, hare, goose, spiders or snake. Place on the activated seal of Gehinnom and call upon the powers of the Seventh Kingdom to bless and imbue it with Their essence so that when burnt it can aid in the opening of the First Gate.

What follows next are 10 simple formulae for the making of the Incense of the Primary Qliphoth. These formulae are kept simple to only act as an introduction to the Work and should in time be expanded and changed to harmonise with the insights gained as reward for correct practice.

All the following blends must be consecrated upon the seals of their corresponding Qlipha, placed and activated within the Assiahic Hendecagram of Evocation activated in the correct manner to correspond with that which is to be achieved, over which the corresponding Qliphothic Formula is chanted 11x11 times, while the heart of the Star is envisioned to burn with the Black Fires of the Other Side, fully enspiriting and connecting the mixtures with and to their own essences.

Incense of Nahemoth:

- 3 part Male Fern leaves
- 3 parts Dittany of Crete
- 4 parts Patchouli

Incense of Samseel:

- 2 parts Jasmine
- 3 parts Mugwort
- 2 parts Tarragon

Incense of Samael:

- 2 parts Mace
- 2 parts Horehound
- 3 parts Mandrake

Incense of Qree Jarag:

- 3 parts Red Sandalwood
- 2 parts Clove
- 2 parts Benzoin

Incense of Thagriton:

- 4 parts Frankincense
- 2 parts Bay Laurel leaves
- 1 part Saffron

Incense of Golachab:

3 parts Tobacco
1 part Asafoetida
3 parts Rue

Incense of Gash Khalah:

3 parts Grains of Paradise seeds
3 parts Copal
2 parts Oak wood

Incense of Gatariel:

3 parts Myrrh
3 parts Cypress
1 part Yew

Incense of Nogi-el:

3 parts Dammar resin
2 parts Thorn Apple leaves and/or flowers
2 parts Morning Glory seeds

Incense of Thaumiel:

3 parts Opoponax resin
3 parts Dragon's Blood
2 parts Fig Tree wood powder

The work of the Blessed Smoke empowering and releasing Spirit from its confines, or granting it garments of manifestation when it seeks to intrude and manifest where it needs to embody its influences, is the key unlocking the doors to the most relevant Qliphothic Operations and must as such always be accomplished as a solemn and humble deed of adoration directed to the Thoughtless Divinity, as union with that Other God always remains the primal motivating cause for all such workings of those that are of the Serpent's Blood.

The Cord

The cord can play a very significant role within the workings of the Qliphothic Adept, both as a very practical tool for measuring and binding and as a more esoteric and talismanic link to the Serpentine Mysteries.

Usually there are two sizes of cord worked with; one being equal in size to that of one's own full length measured from head to toe, while the other lesser one only measuring in length as the space between the shoulder to the tip of the middle finger.

The cord representing one's full length is a very personal link that represents one's own full incarnated being and can as such be used to cause connection to those forces with which one seeks congress and can after proper consecration act in form and essence both as a Serpentine Shadow of one's self and as the umbilical cord linking one's own being to the Serpents of the Other Side.

Such cord, most often made of strong black leather, must be cleansed by being washed in the infusion of Rue before being cut to size and before cutting the cord measures should be taken to ensure that the cord becomes in size as close to one's own length as possible. The cord is then tied around the waist touching directly the skin for a duration a full night and a day, in order to strengthen the enlinkment to one's self and after that period removed and kept upon the altar until its full consecration.

At the time of the consecration the Assiahic Hendecagram is to be established upon the altar as the aim is to manifest the Light of Azerate within the cord. All Eleven Heads are called upon in the correct succession, starting with Satan and ending with Na-Ama-Hemah, lighting each candle only after the eleven times chanting of the Formula of Calling of each ruler and tracing each line of the Hendecagram only at that point, leading thus the fiery presence of each Head from one Primal Seed Point to the other, so that first after Na-Ama-Hemah's

formula has been chanted and her flame lit the eleventh line/reflection becomes drawn to unite the Eleventh Point with the First, being the one belonging to Satan, and thus creating the proper and activated Hendecagram of Manifestation, calling upon and connecting to all of the Eleven.

When this has been done eleven flames burn on the points of the Evoking Hendecagram of Assiah and the powers of Azerate can be accessed. The Cord is at this point fumigated with the Incense of Echad-Asarel or some other suitable formula worthy of being given as burnt offering to the Eleven and each Head is adjured to grant blessing of enlinkment through the cord to their own Essence.

The cord is at this point knotted eleven times, each time in the name of one of the Eleven and in the correct order of succession as the formula of each Head is whispered into the knot before it being pulled and closed tightly. Blood is then drawn from left hand's middle finger with the aid of either the Knife or a, in beforehand cleansed, needle and smeared upon each knot as a pact between one's Self and the corresponding Head of Azerate. The bloody knot is finally passed eleven times through the corresponding candle flame and by blood and fire the pact is sealed and the enlinkments fortified.

This whole process is repeated until eleven knots have been tied, bloodied and scorched and one's full being has been firmly bound to the Dragons of Sitra Achra, of which the Eleven-Knotted Cord at this time becomes a fetishistic and talismanic representation, embodying one's self as part of the Eleven-Headed Serpent and thus permanently connected to Azerate. This cord becomes at this point a most powerful talisman and a protective amulet at the same time, strengthening all connections to Sitra Achra, making easier the channelling of their Black Light, while also offering protection against both Qliphothic emanations that could cause unwanted and adverse effects because of one's Sephirothic coverings and shield against the Archonic attacks and spiritual assaults that the Qliphothic Fires of the Eleven could protect against.

The knotted cord is thus carried upon one's person, either as a belt or around the neck when its influences are sought the most, be it during ceremonies or in the more mundane settings, but within other contexts the same cord can be used for the binding and dominating of others through the Qliphothic Powers it carries enlinkments to and serve many other purposes which become revealed in time to the owner and will sooner or later become realised to very literally be a manifestation of the Serpents of the Other Side.

This sacred knotted cord can also esoterically act as a ladder of ascent or descent and serve as bridge through which soul, mind and Spirit are projected towards the Qliphothic Points of the Eleven.

Such Knotted Cord of Azerate should receive a proper sacrifice once a year, the most befitting date for such empowerment being the 11th of November each year, which also is the most auspicious date for the initial creation and consecration of this talisman. While this date has no historical significance for those outside of our Qliphothic Cult the meaning it has been given within the Tradition embodying the Current 218 has made it into a Holy Day and Night and a point in time during which the Light of Azerate is channelled and spread and different rites are conducted with the aim to keep strong and strengthen all links to the Side of Thoughtlessness.

The lesser cords can be employed in similar manners, but serve more often the more practical purposes of the Knotted Rosary, with the aid of which the recitations are counted, applied within the workings of ligature or in other more sorcerous manners taught to the faithful by the Spirit of the First Weaver and Spellbinder, now Enthroned in the Tenth Qlipha.

Blood Sacrifice

The Blood is the Life, meaning that all the subtle components of being when intermingled manifest their accumulation via the life-force germinating into the finite condition of life and, through blood, further similar birthing into being can be caused and thus when blood is given to Spirits that would otherwise not have foothold within this world of living matter they can by such offerings be given the means to become manifested where they otherwise would not had natural means for the living materialisation of their influences. This being especially the case when it comes to the forces of the Other Side as they have no natural anchoring within this world and in order to manifest they must intrude and invade Points of Manifestation which are unnaturally made to fall under their powers.

The blood being the physical vehicle of the 'animal soul' is thus a means for the embodiment of Spirits on the lowest planes of existence, without enslaving them to matter, as the force of blood spilt is fleeting because of its lack of self-sustenance and regeneration after the death of its material corpus. The possession of the life-force of the living can also be accomplished by Spirits via different forms of vampirism, but such slow process is much more demanding and less useful when it comes to the causing of concrete and potent manifestation if compared to the forceful ejaculation of life-force that a quick death through the act of ritual sacrifice brings about and directs towards the receiver of the offering and empowerment so given.

The act of sacrifice is also within the context of our Qliphothic Work truly a sacralisation of the victim, as its essence becomes elevated within and through the Higher Spirit receiving it as an offering and all such deeds of necessitated bloodshed must therefore be conducted with the greatest of respect and care for the animal so offered up for the greater cause and one must during all such operations contemplate the fact that a sacrifice meant to elevate can only be accomplished properly

by one that is ready to not only give of others but also who gladly engages in the Martyrdom of Self-Sacrifice for the sake of others serving the Sacred Cause of Thoughtless Spirit when need be.

The death of each victim should thus always reflect the death of some unworthy aspect imprisoning one's own Spirit, by the replacement of the clay-born profanities with traits instead elevating and glorifying the victim and one's own Spirit upon the egoless Path of Sacrifice.

As the world is inhabited on all levels by parasitic beings serving only the cause of obsession and attachment to the clay-born impulses holding the Spirit enslaved all blood sacrifices must be conducted in the proper manner, within the confines of sacred space interlinked to the Other Side, either established physically or astrally, mentally and spiritually and within the actual presence of the intended receivers of such offerings, invited to be present through their established Points of Manifestation, such as their seals, opened gates and Formulae of Calling.

As for the exact selection of fitting offerings there are many considerations that could be taken into account, such as symbolic and sympathetic attributions and enlinkments, the actual traits of the animal, the expressed wishes of the Spirits if such contact with them already has been established, the context within which the offering is to be given and the size and therefore also the amount of blood and life-force of the chosen sacrifice, so that it fits and manages to aid in the accomplishment of the goals of the operation it is intended for.

As already hinted at throughout this book the snake is an animal held sacred within the Qliphothic Cult and as such it holds the highest position when it comes to the work of blood sacrifice. The snake chosen for such rites should preferably be venomous, even though also nonvenomous serpents are held in high regard and considered most holy, with the difference being that when the snake poses a threat to the

operator the scales of sacrifice become more balanced and attuned with the solemnness of the work at hand and also the fact that by the grace of its venom the snake holds stronger enlinkment to Sama-El-Acher.

Such snakes should be taken care of and adored as representations of the Messiah of Black Light for 7 or 11 days and nights, during which the operator should fast and abstain from the profanities of this world and remain clean both in body, soul and mind, with attention directed only towards Spirit, glimpsed within the dark of the eyes of the venerated serpent.

Only with such approach towards sacrifice can the full impact and sacredness of the offerings given be realised, focused upon and properly directed.

The remains of all sacrifices not employed further within the fetishistic or talismanic arts, or those connected to the making and blending of elements and powders, should be respectfully taken out to a suitable location, such as a forest and there be buried by a tree or in some other place of relevance as a gift to allied Spirits dwelling close to or otherwise reached through such loci.

May those that are not ready to sacrifice what they demand others to offer up on their behalf harvest nought but scourging affliction and may those that through each offering also give up of themselves for the furthering of that which serves the cause of the Liberation of All gain more and more of that which is truly empowering, essential and of Spiritual Worth with each and every demanding sacrifice staining their altars and manifesting Thoughtless Holiness.

Atah Gibor Le-ohlam Azerate!