

LESSON 170 to 173

SEALS OF THE SCHEMAMPHORESCH

These four lessons cover the seals or sigils of the Schemamphoresch used by the Golden Dawn Adepts. For many years the origins of these seals were a mystery to those members of the New Zealand Order save that they were among Felkin's papers and were never included as 'Official' but like a lot of other Order documents of this status were still never the less widely used. In the early 1980's a fellow occultist by the name of Hans Nintzel, from Dallas, Texas sent me a copy of a set of seals of the Schemamphoresch (in what appears to almost certainly be Mathers handwriting) from the papers of the late Carr. P. Collins. A comparison between the two versions of the seals shows that the Mathers' rendition of the seals were not enclosed or ringed with the name of the angel it represented, other than that they are identical. A note on the Mathers' version of the seals states that these were obtained "By the Great Magician Blaise Vignaire-A.R.2494".

The actual method of using the seals was reserved for Inner Order members within the Golden Dawn though it has been included here as reference material for when the student is ready for this type of work. Normally one did an Evocation ritual of the angel concerned, on the relevant days of the year (to be worked out astrologically) that the angel governs and the seal was used as a warrant to command the angel to obey you. For full instructions on Evocation is covered in the Z2 section in the 'Complete Golden Dawn System of Magic' though this is not for beginners. The seals are to be used neither as a talisman nor as a lamen but a force to bind the angel (who is constrained by it) to perform a desired task. An example of this type of use is given in the Mathers translation of the 'Key of Solomon the King' and 'Grimoire of Armadel'. Other uses for the seals were as astral doorways in which the angel was investigated on the days it governed through skrying. From this investigation some Adepts built up a God-form and used the ritual of God-form Assumption, through invocation to test its powers. There are a variety of uses for these seals and within temples such as Whare Ra, in New Zealand, the associated Biblical Psalms were generally read out in Hebrew to help with the invocation or evocation.

P.Zalewski

Vahuaiah

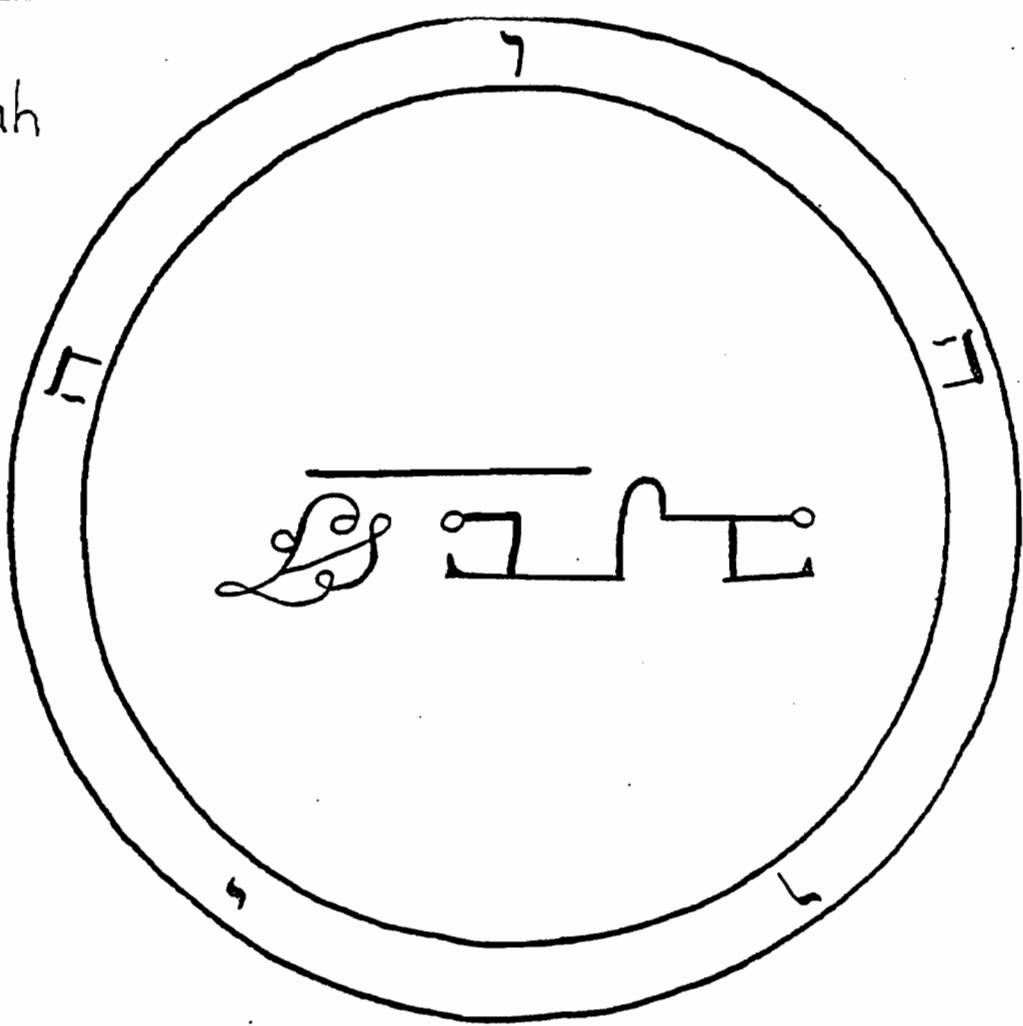

Yelauiel

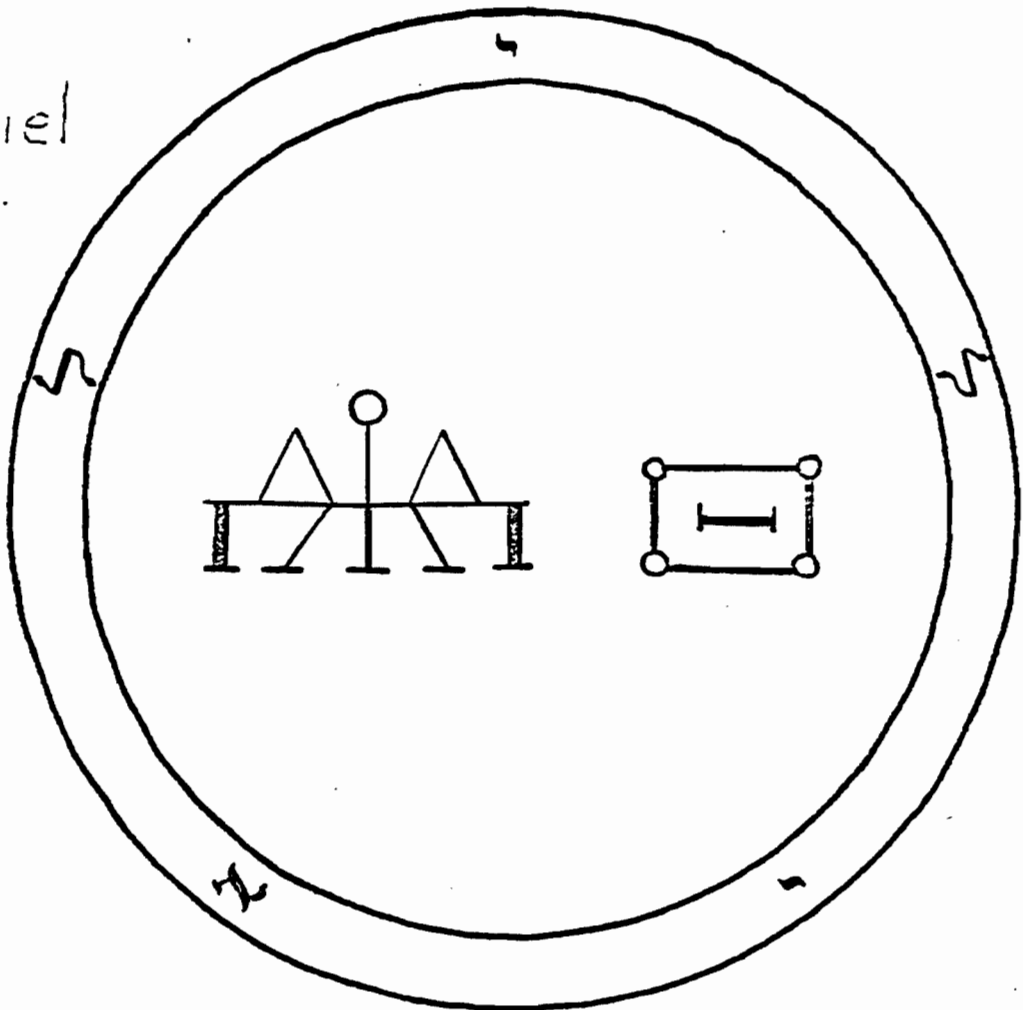

3 Saitiel

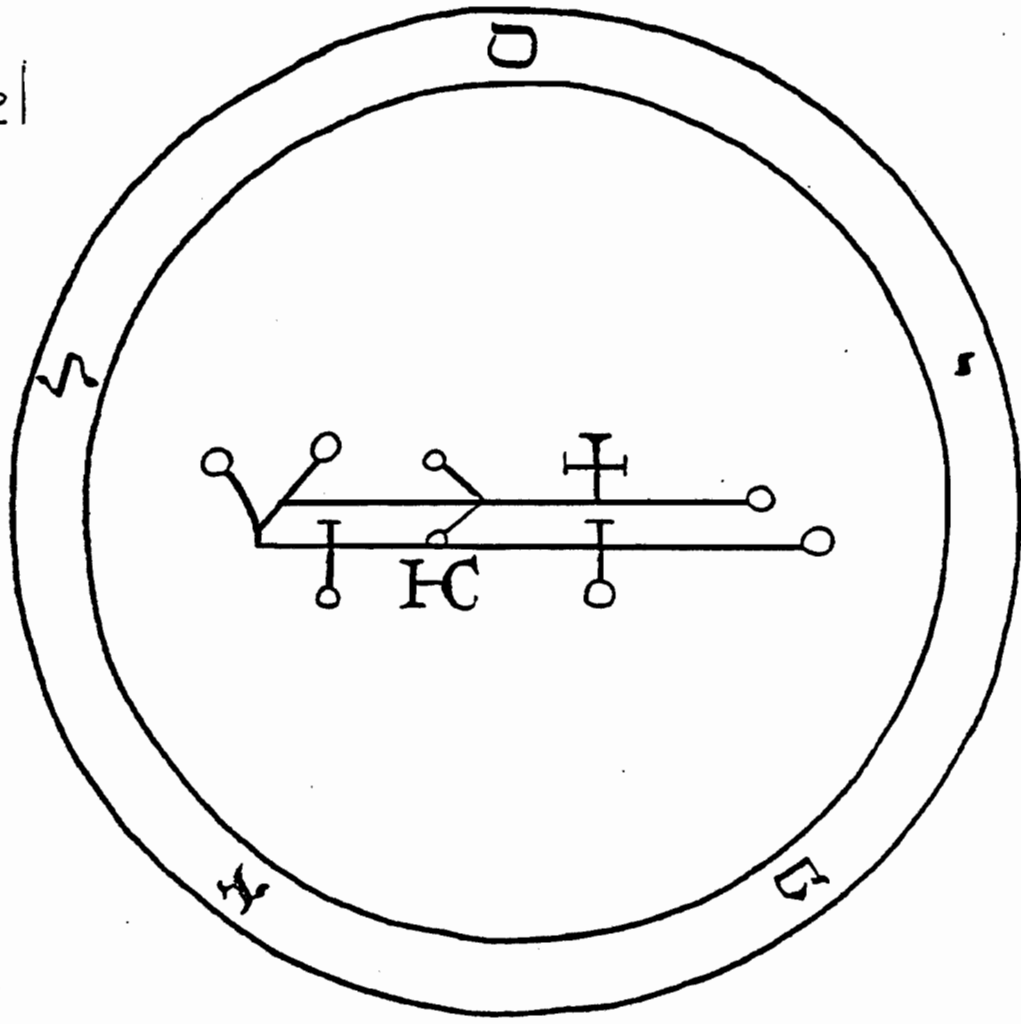

4 Nghelemiah

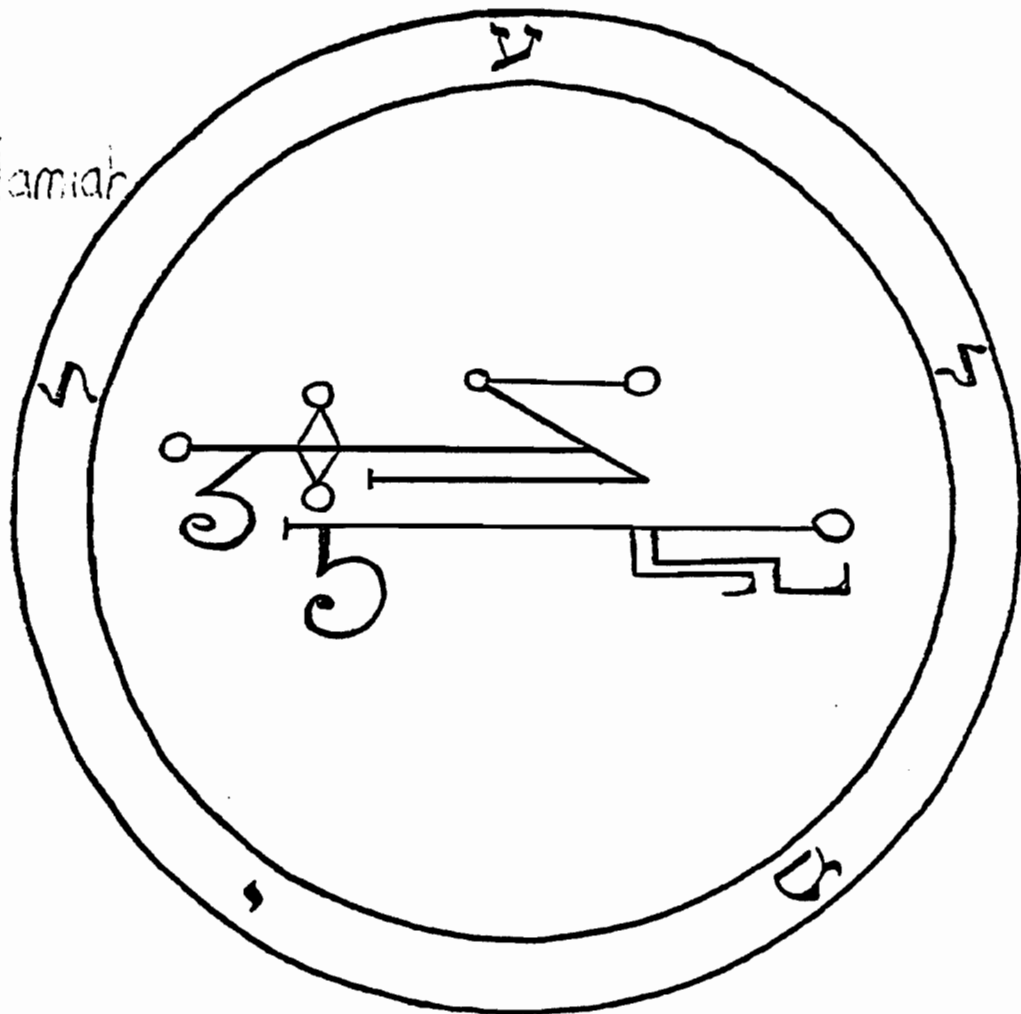

5 Mahashiah

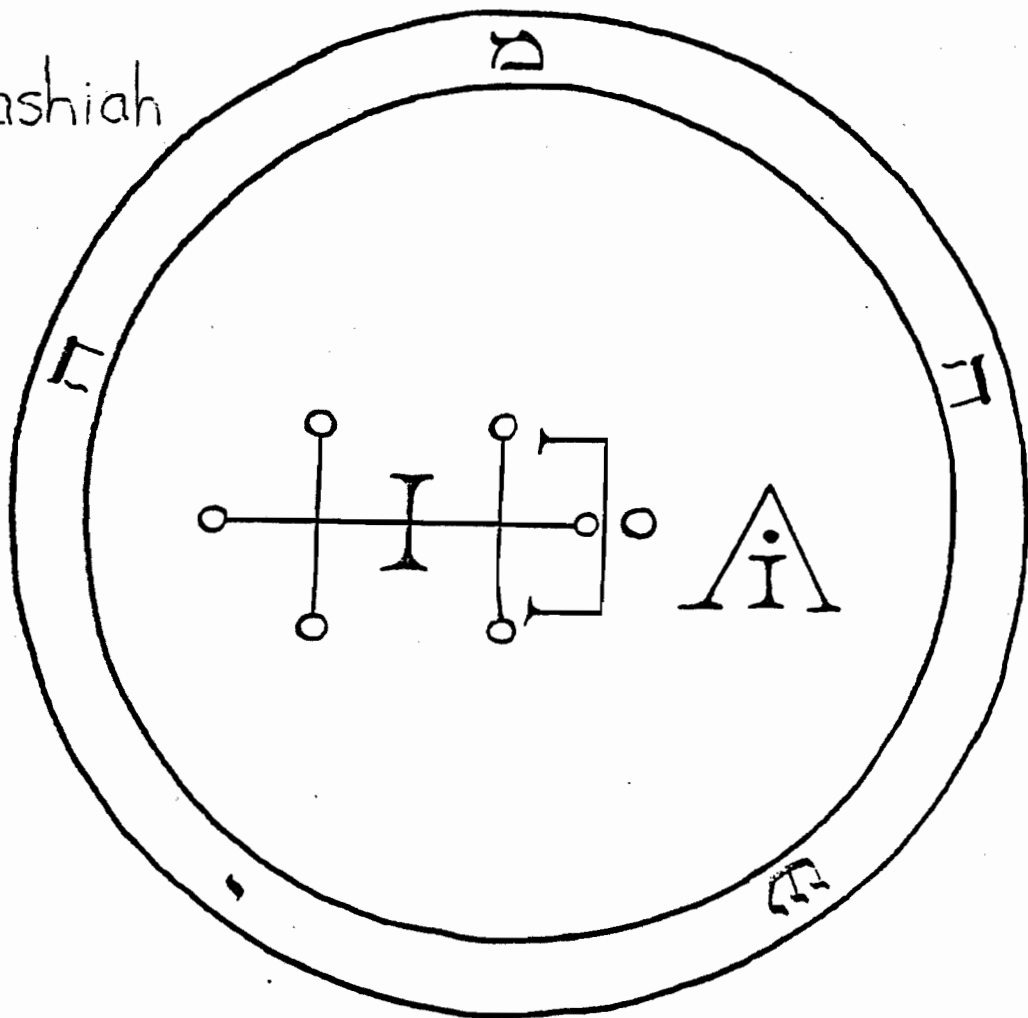

Lalanel

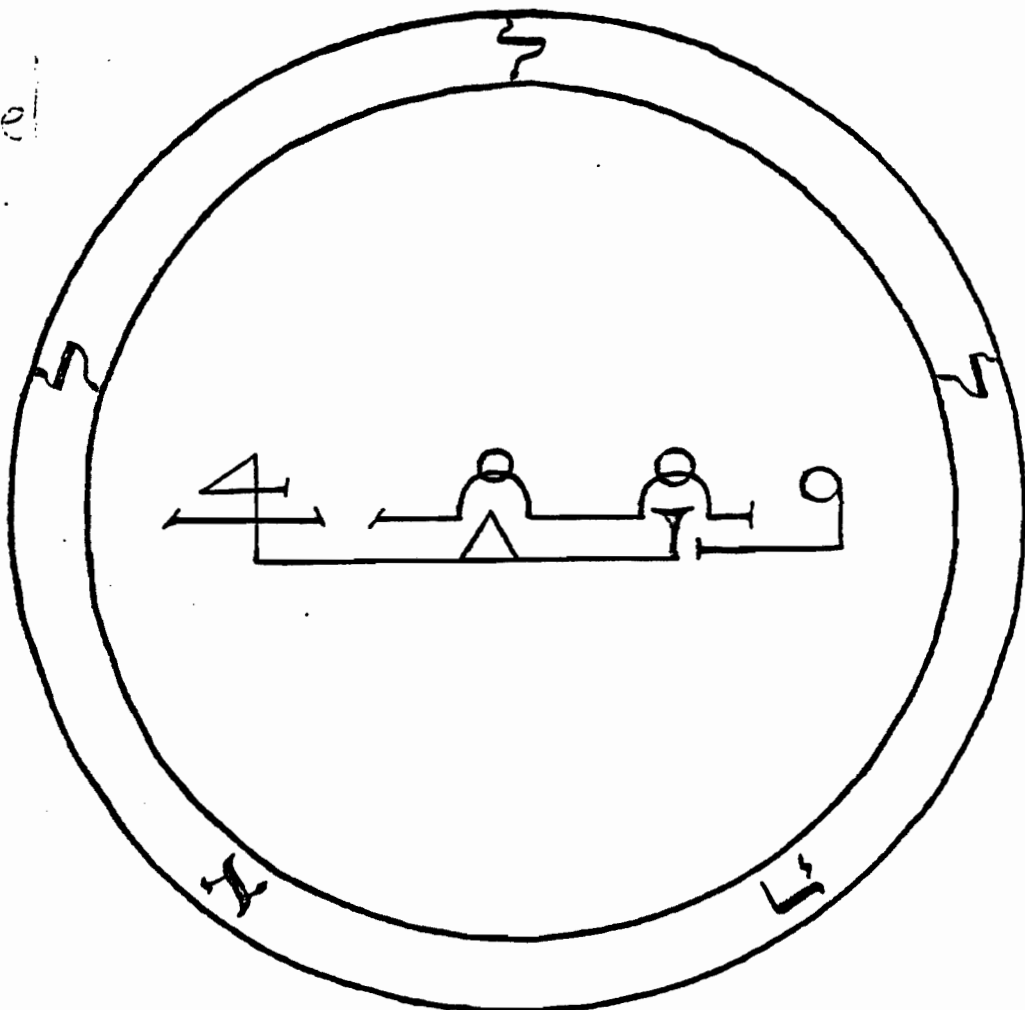

8 Kehethel

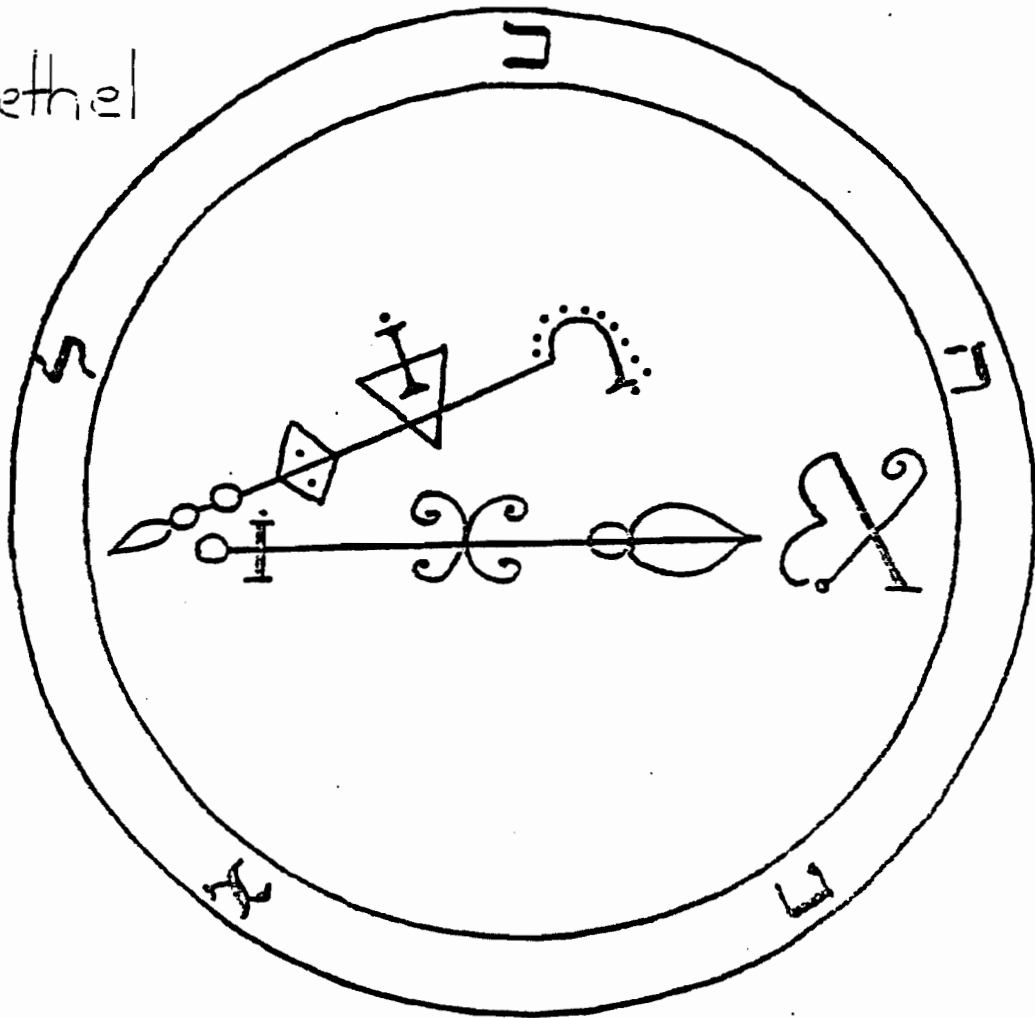

7 Akan

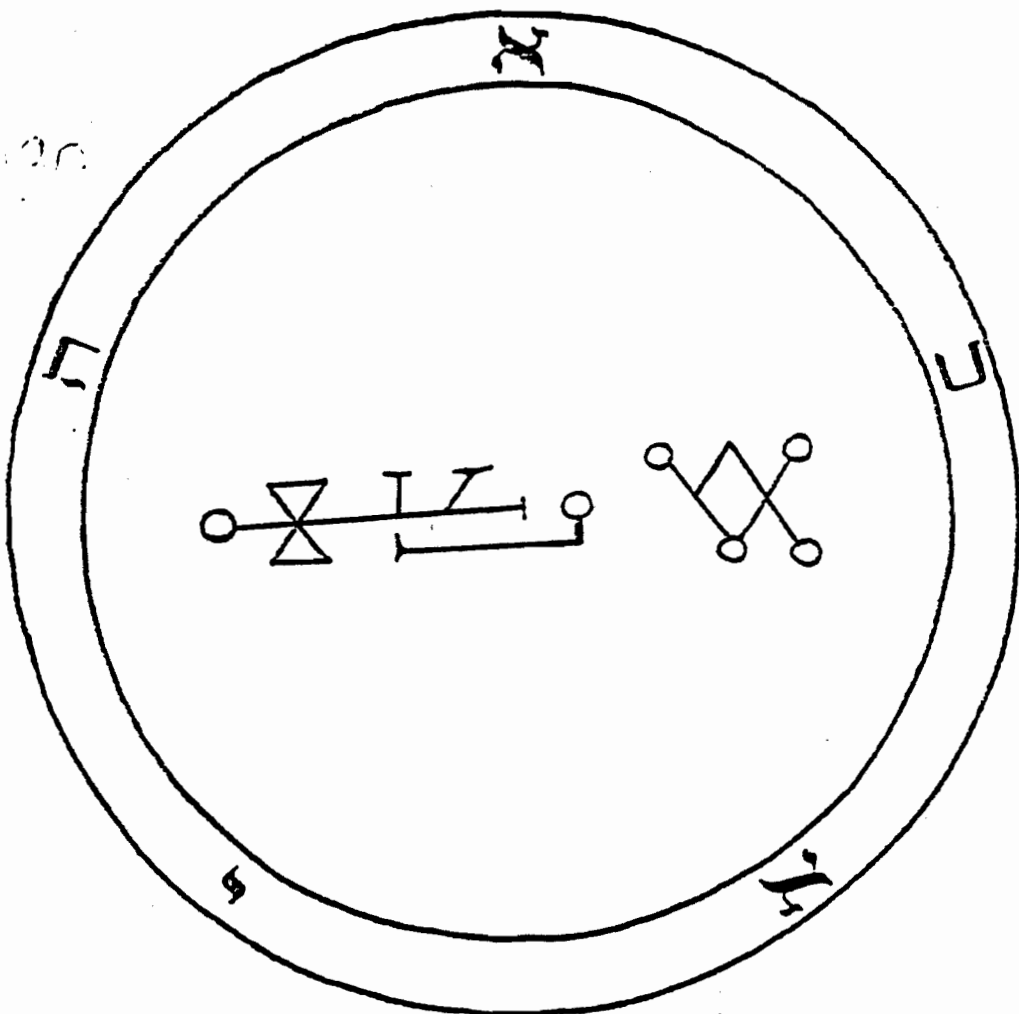

9 Hazeyael

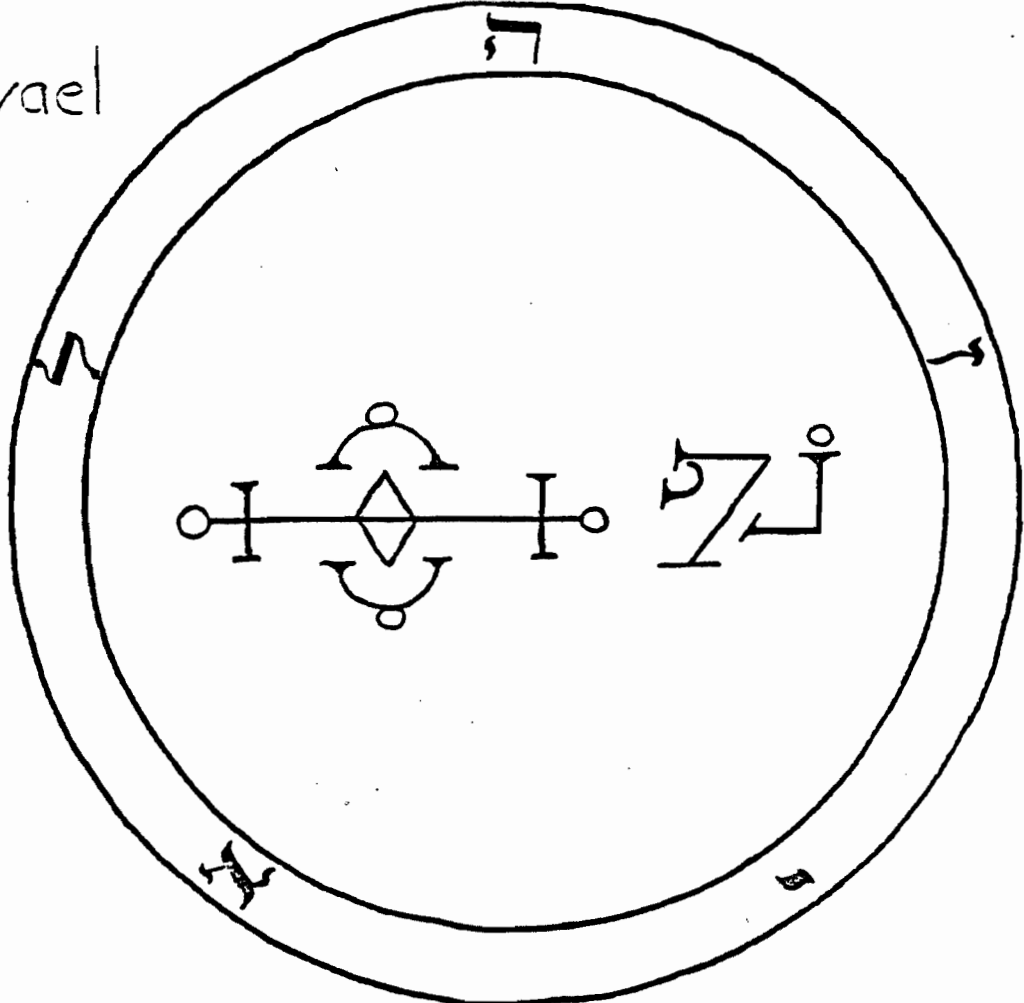

10 Eldiah

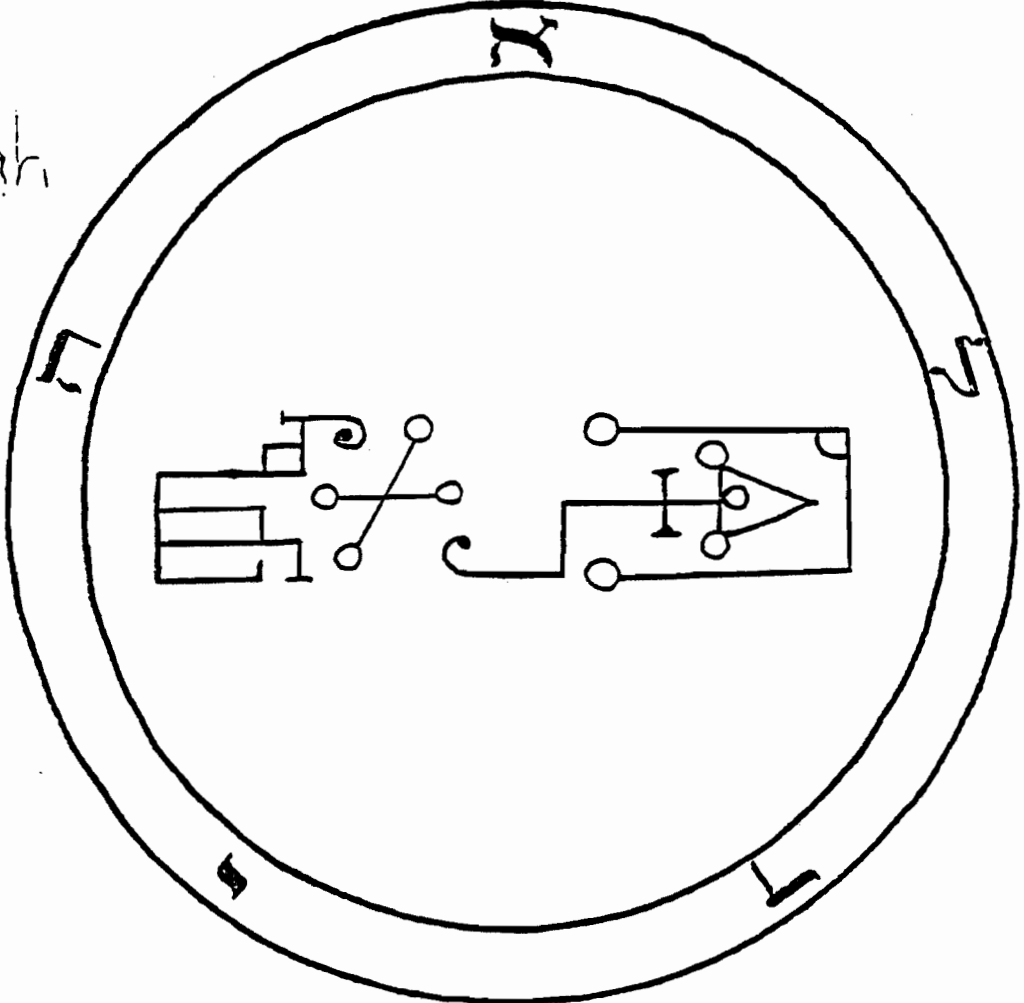

Leviah

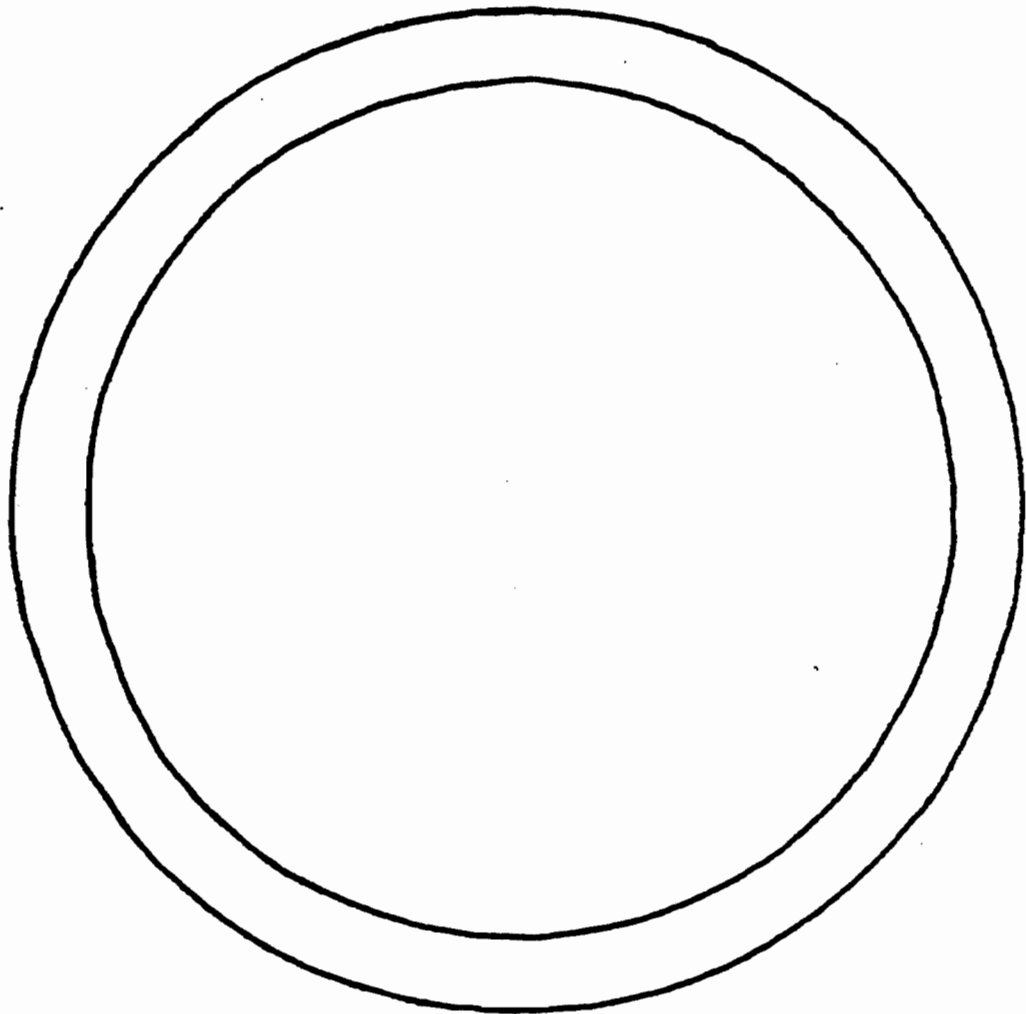
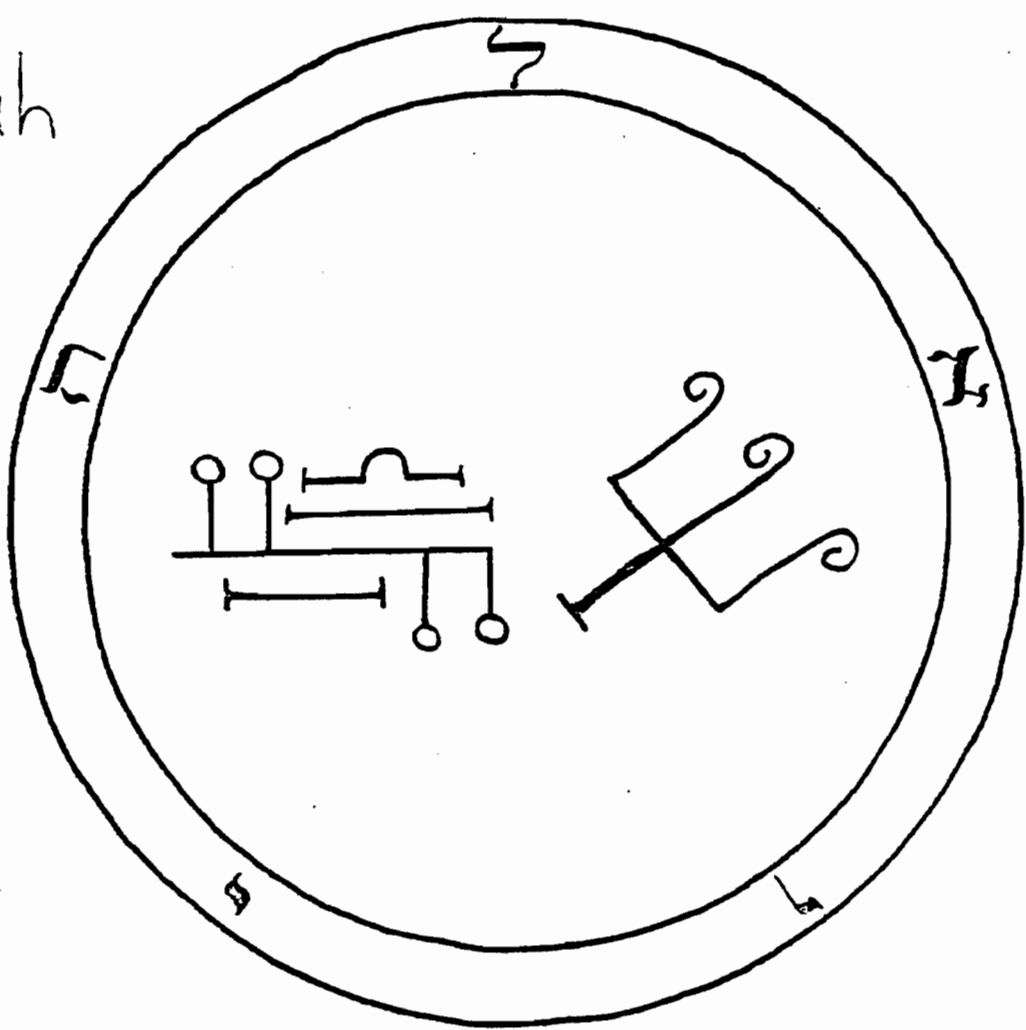

12 Hihaiiah

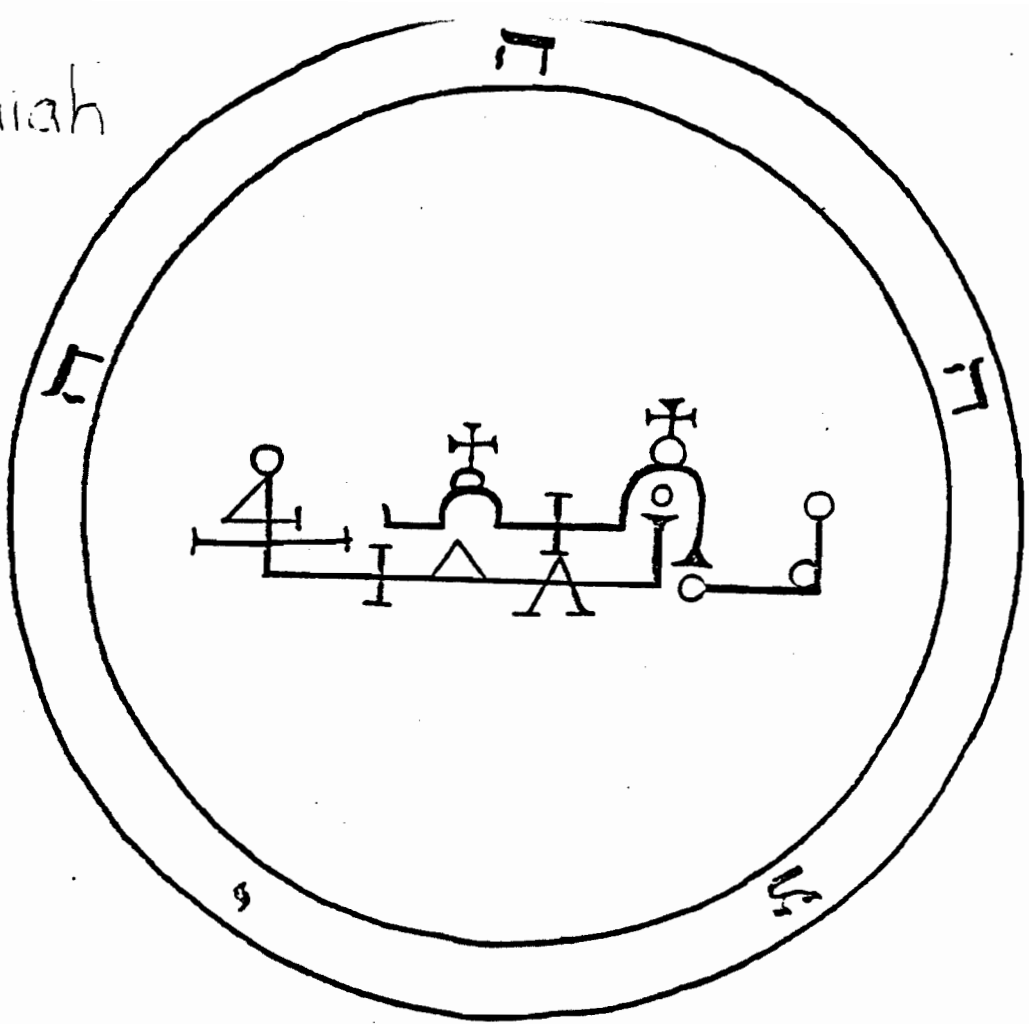

Iezolel

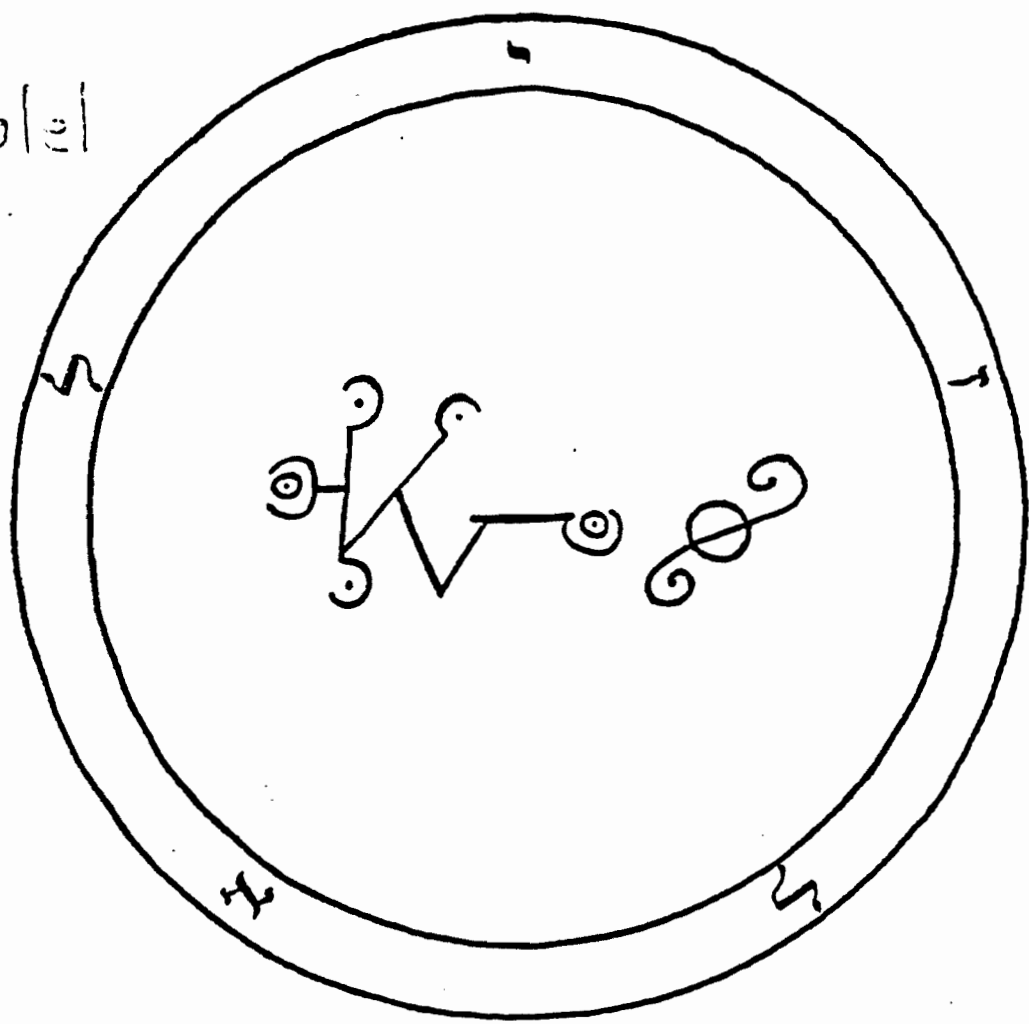

4. Mebahael

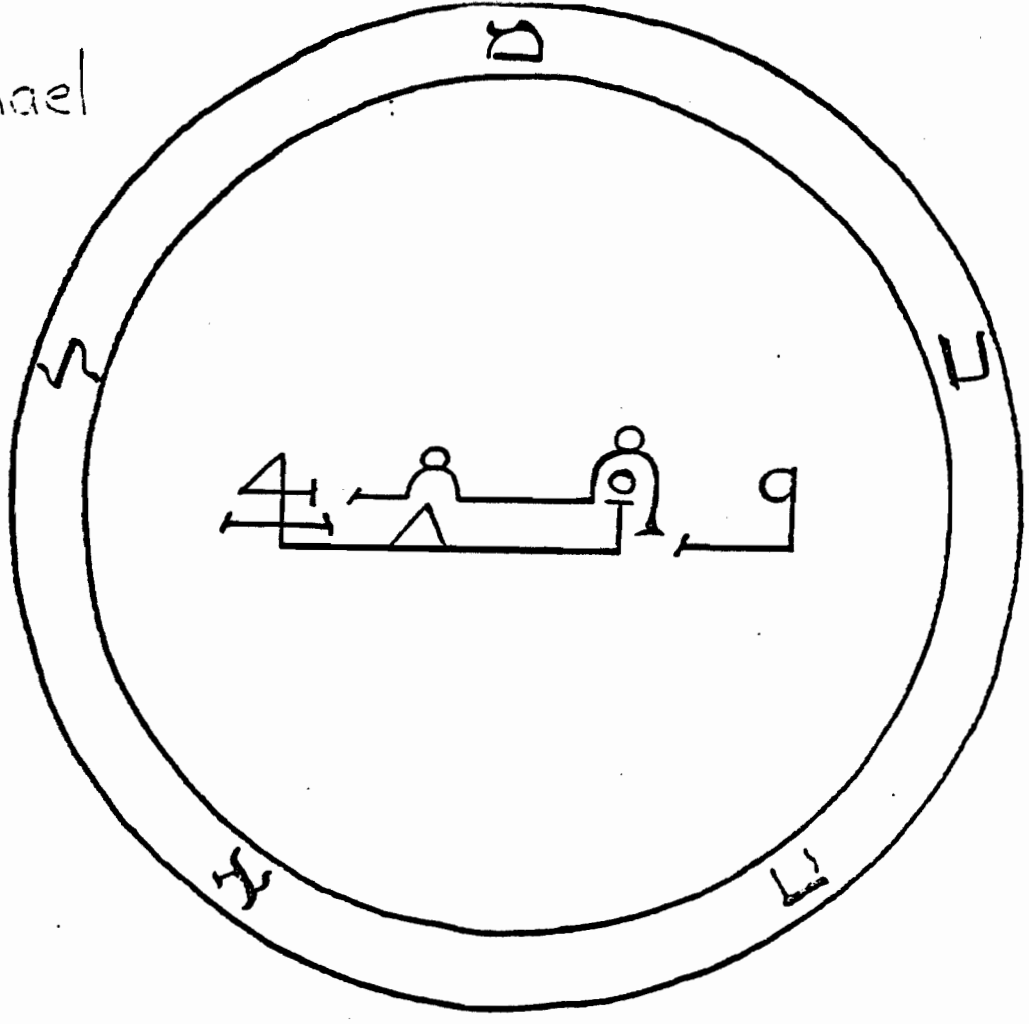

5. Harayel

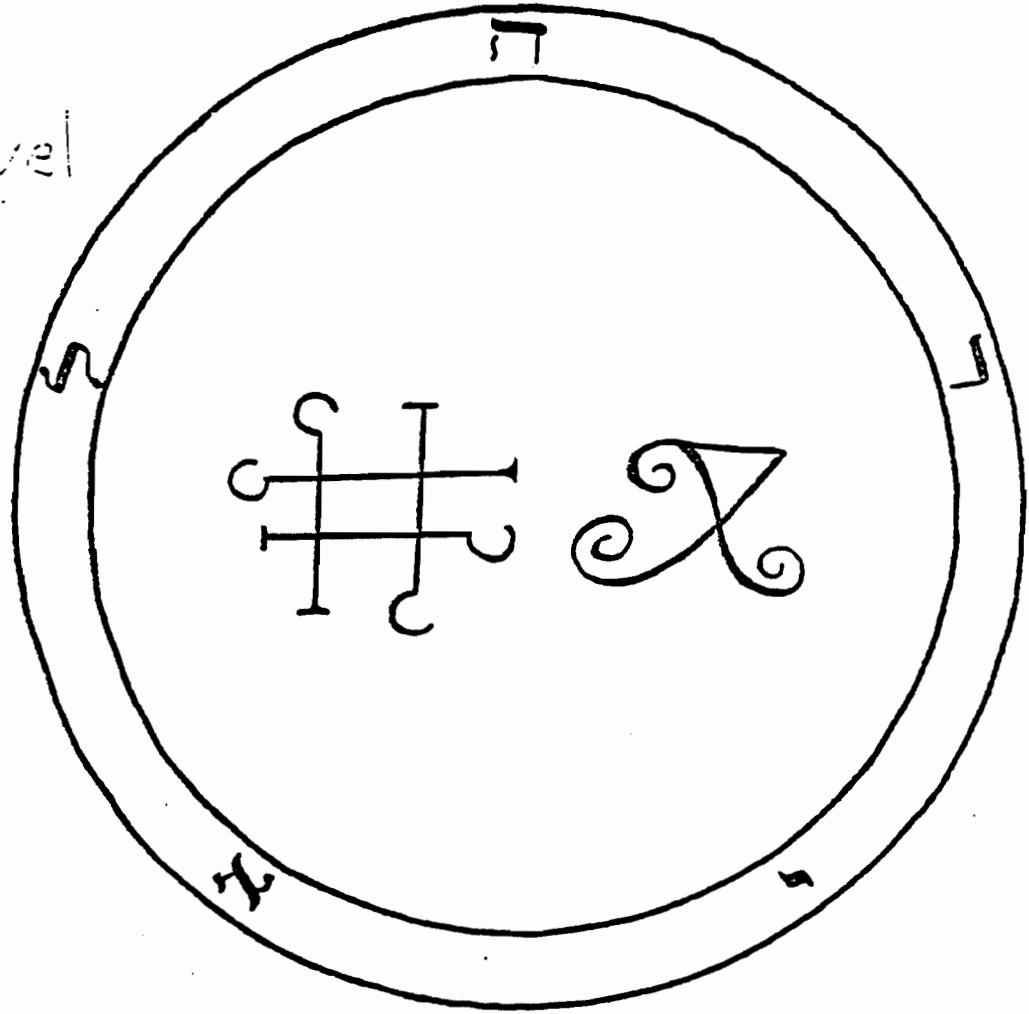

6. Hagamiah

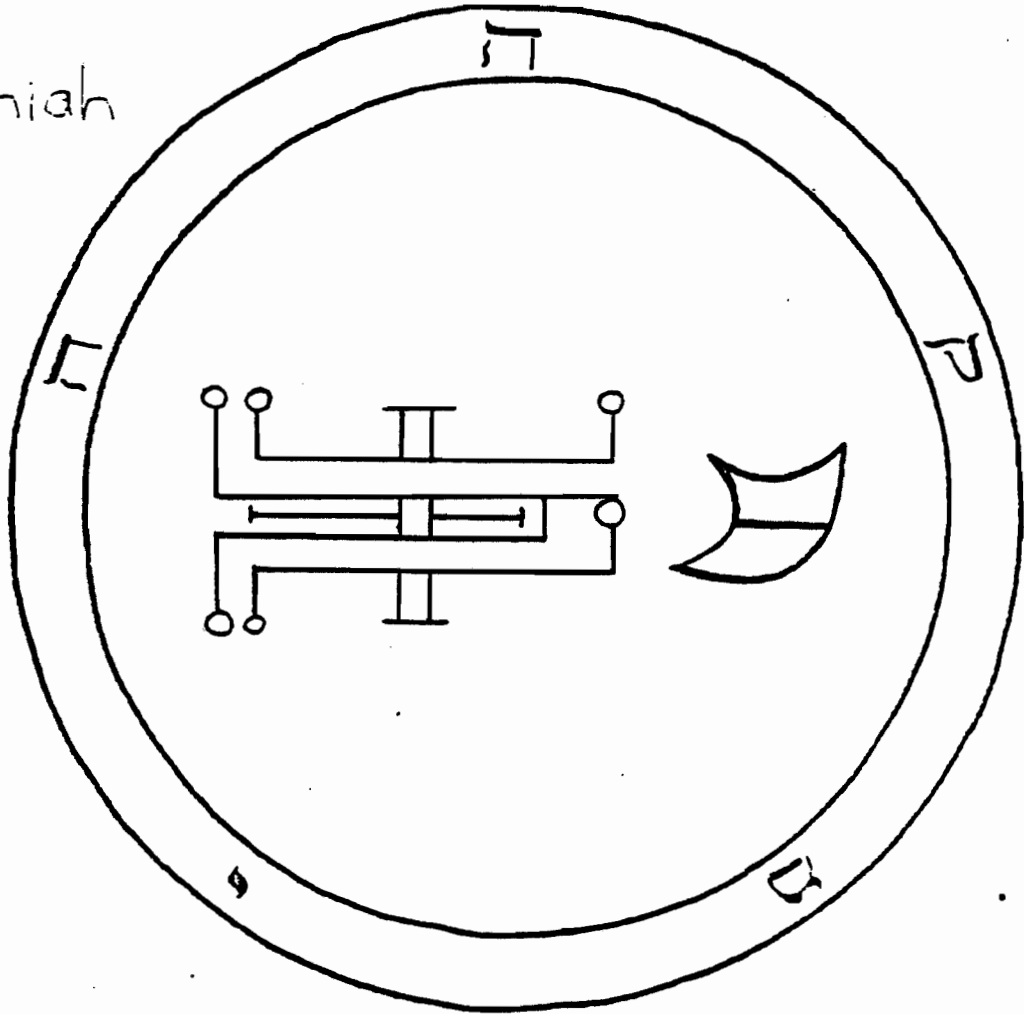

7. Lauiah

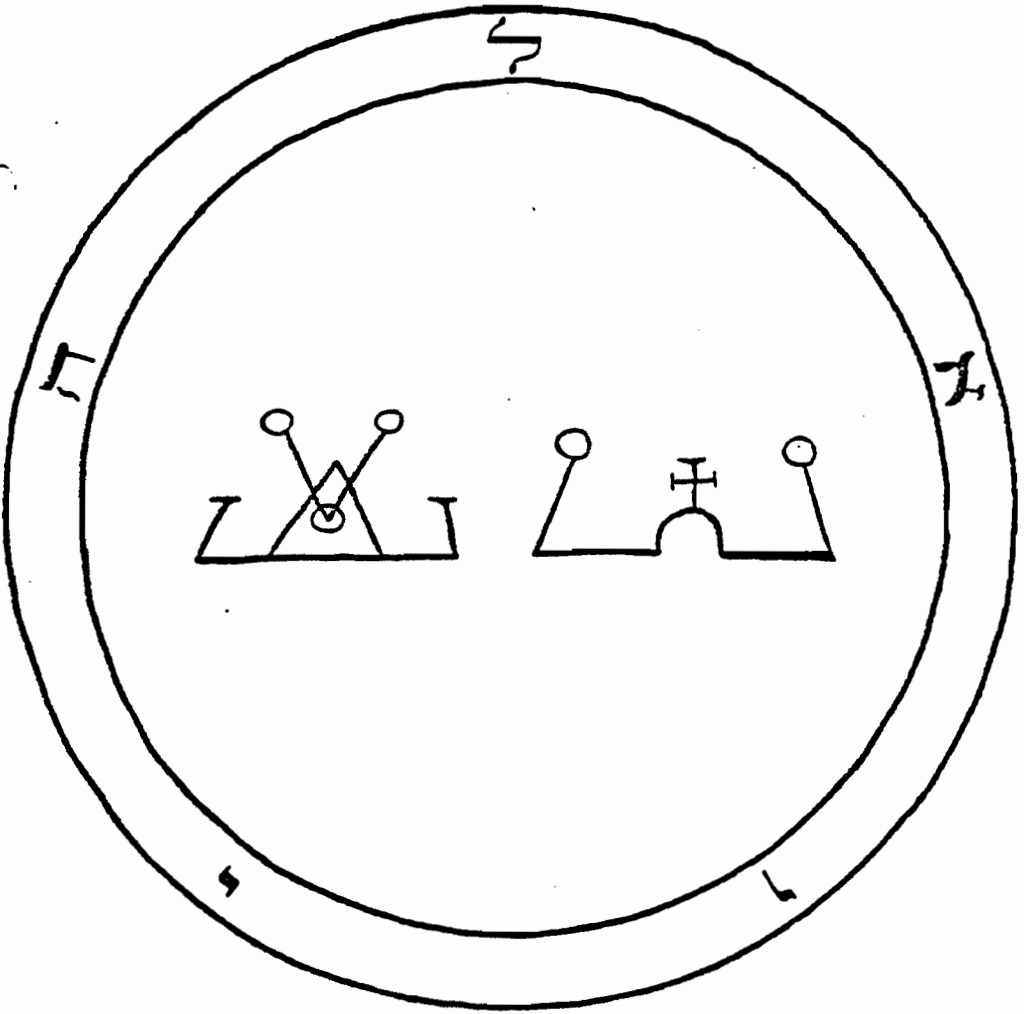

8 Keliel

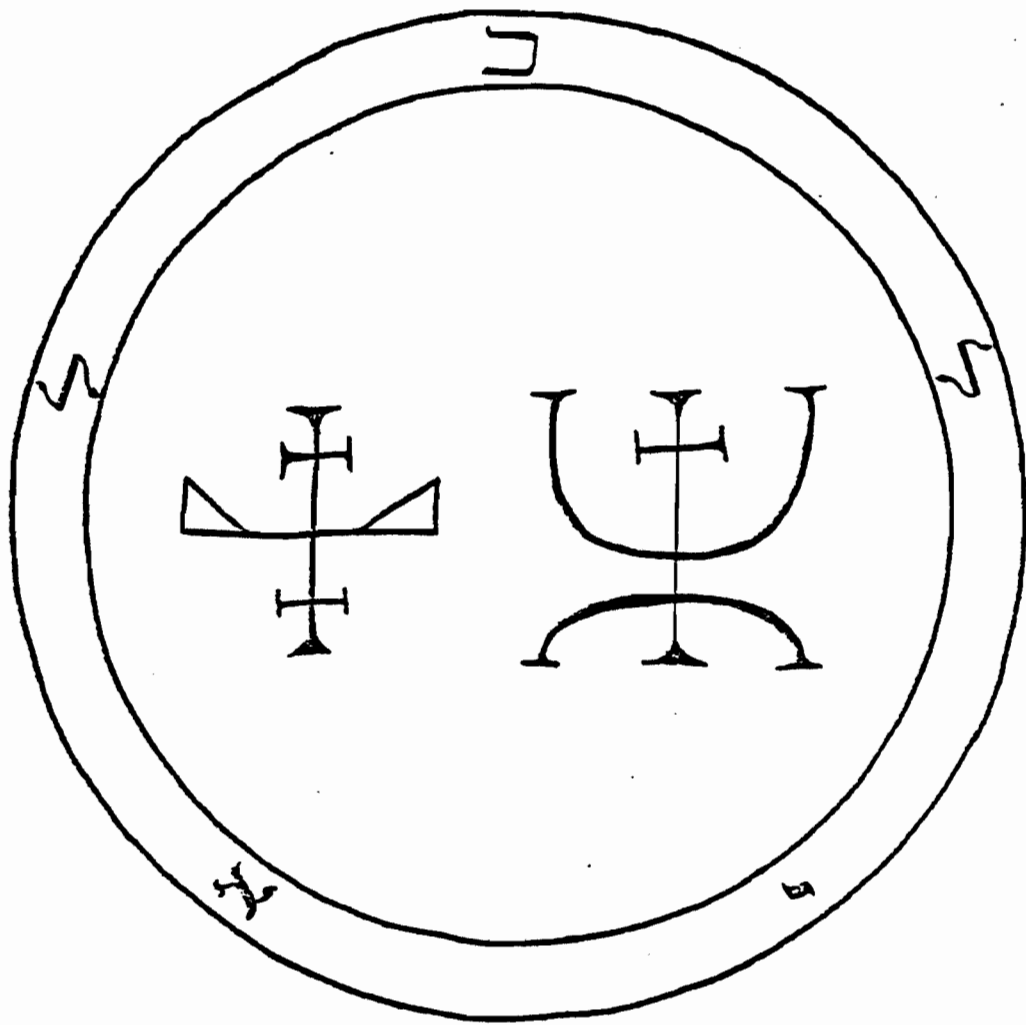

9 Livorah

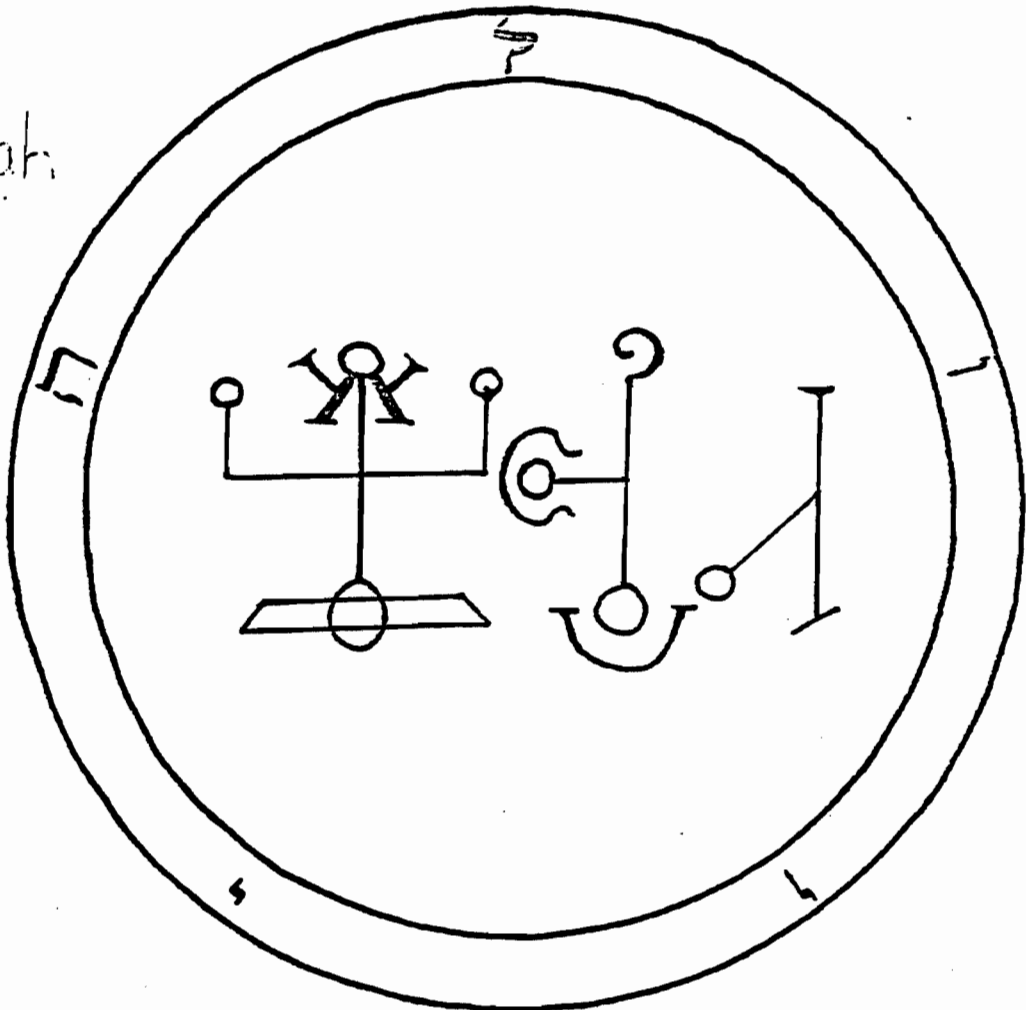

20 Piheliah

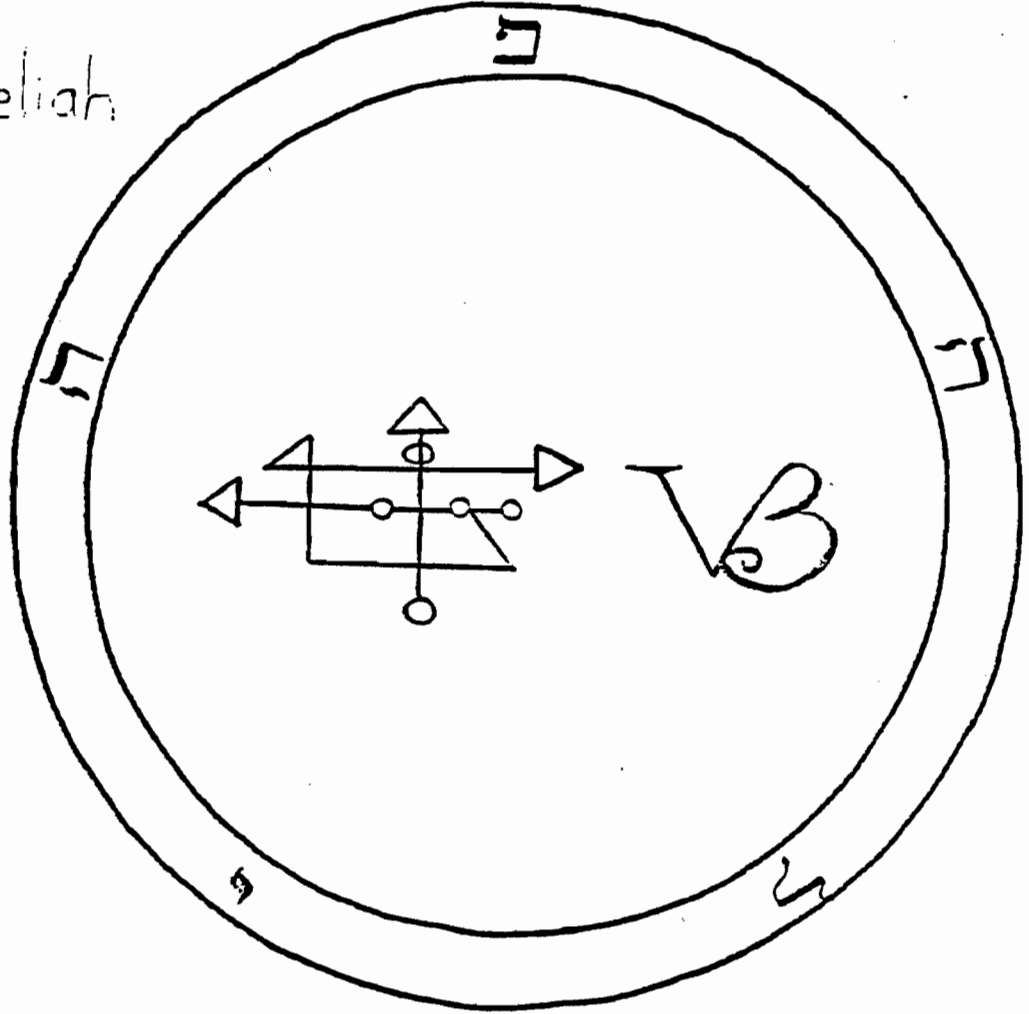

21 Nelakhel

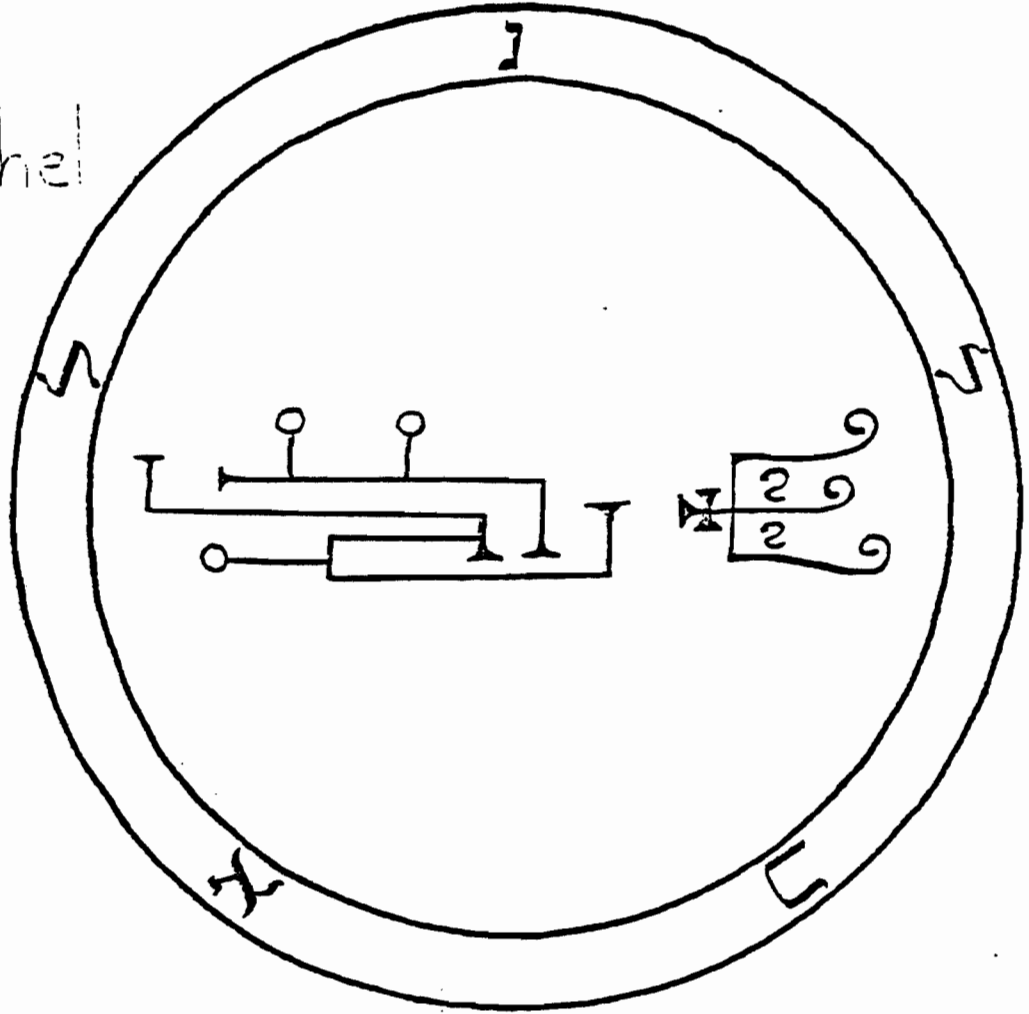

2 Yeiael

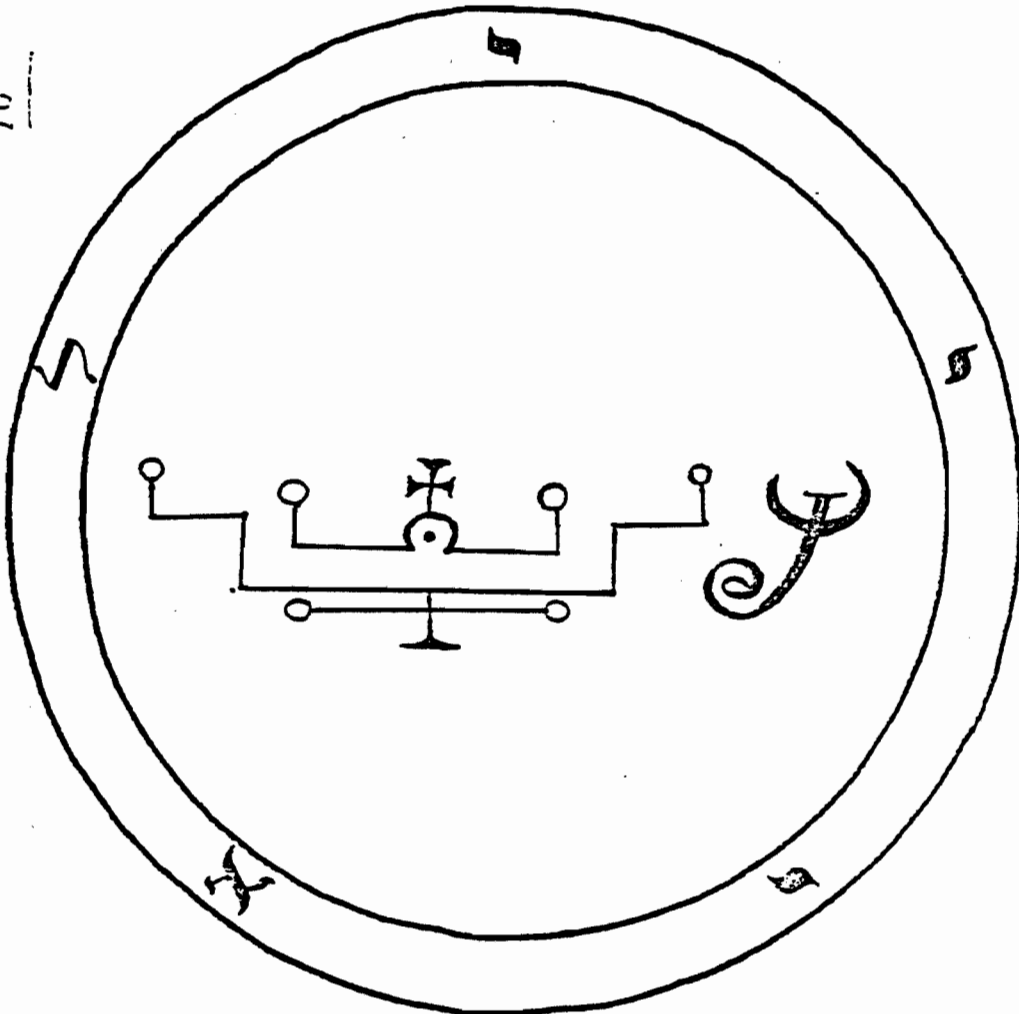

3 Malahel

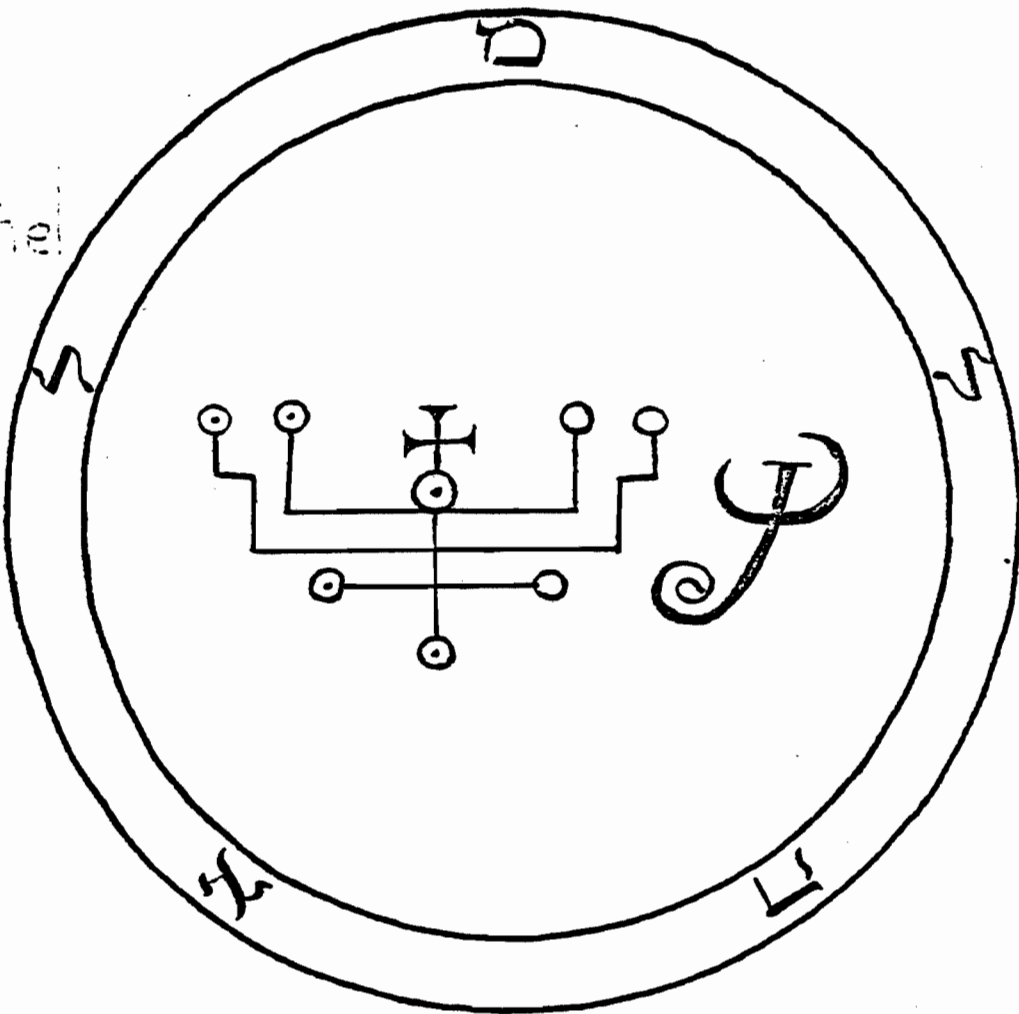

Hahauiah

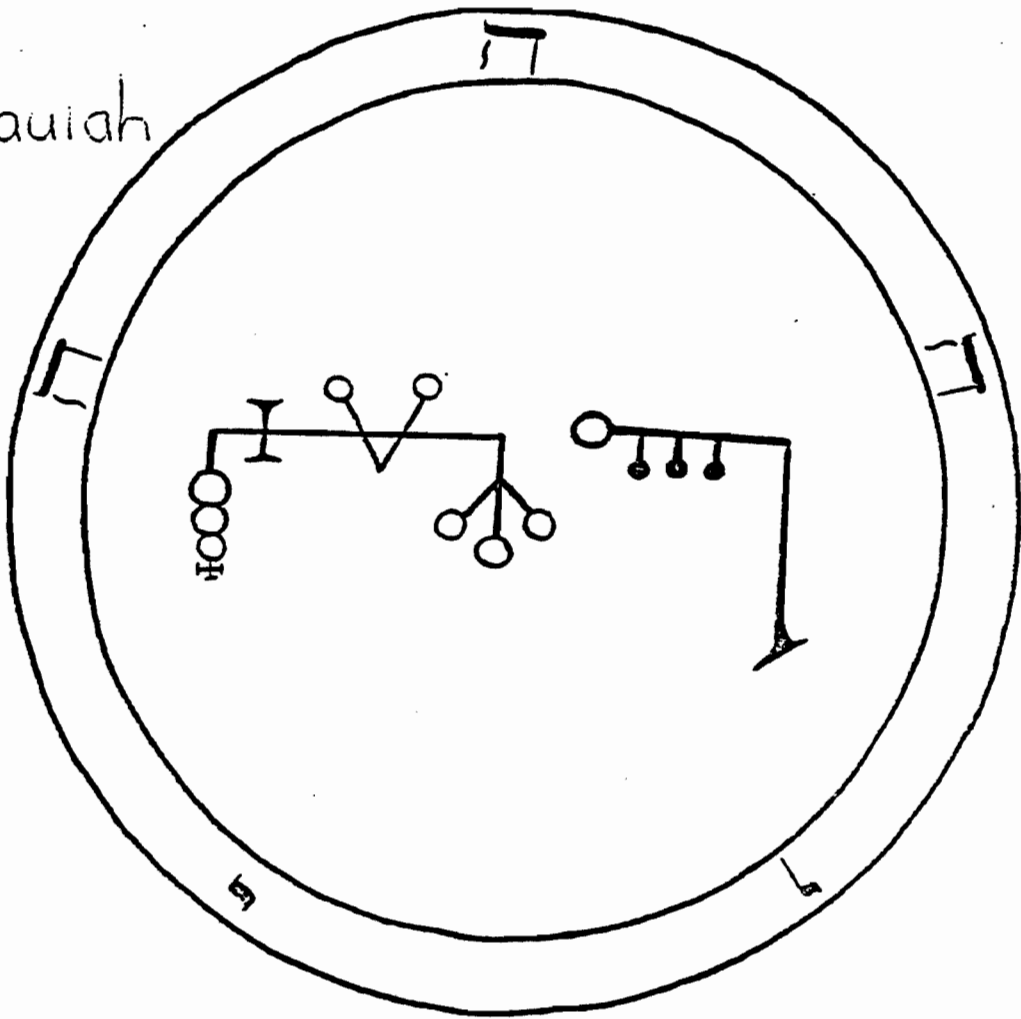

Net-hind

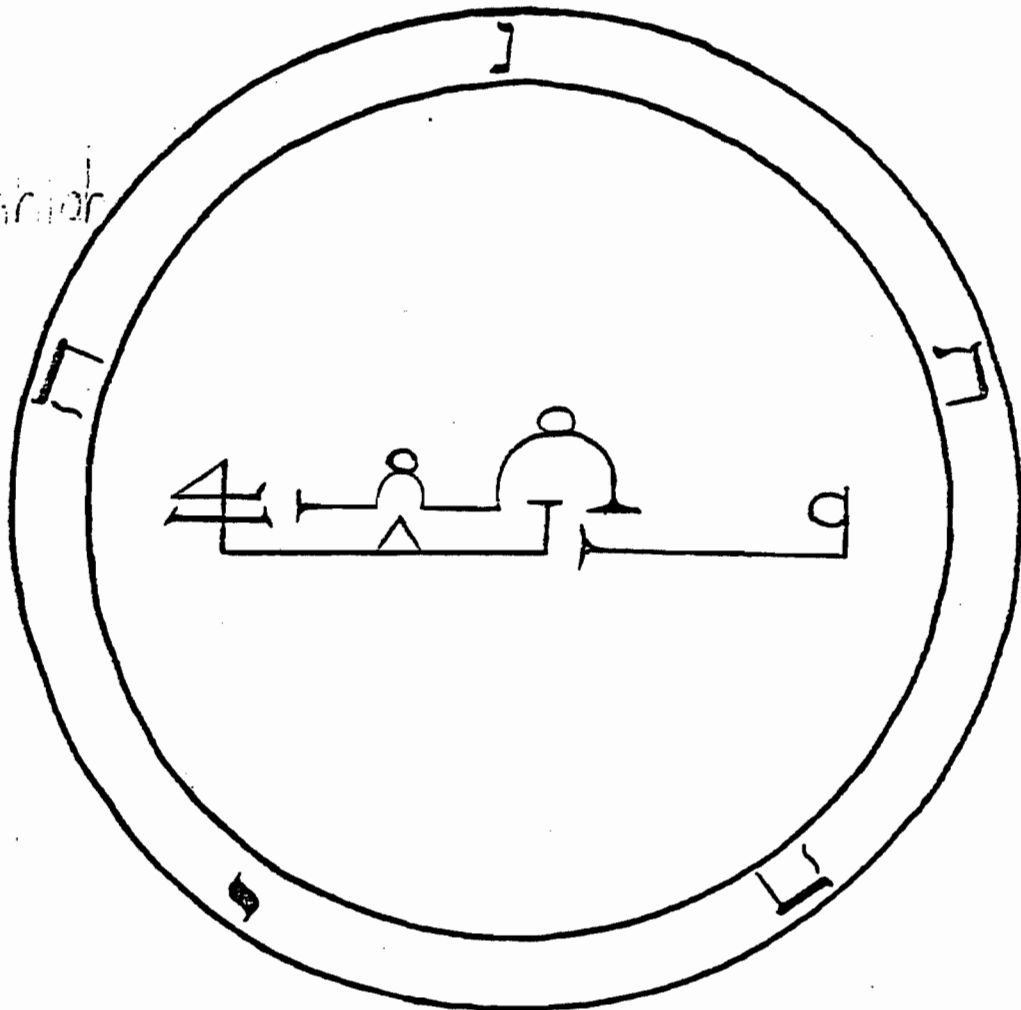

Heeiah

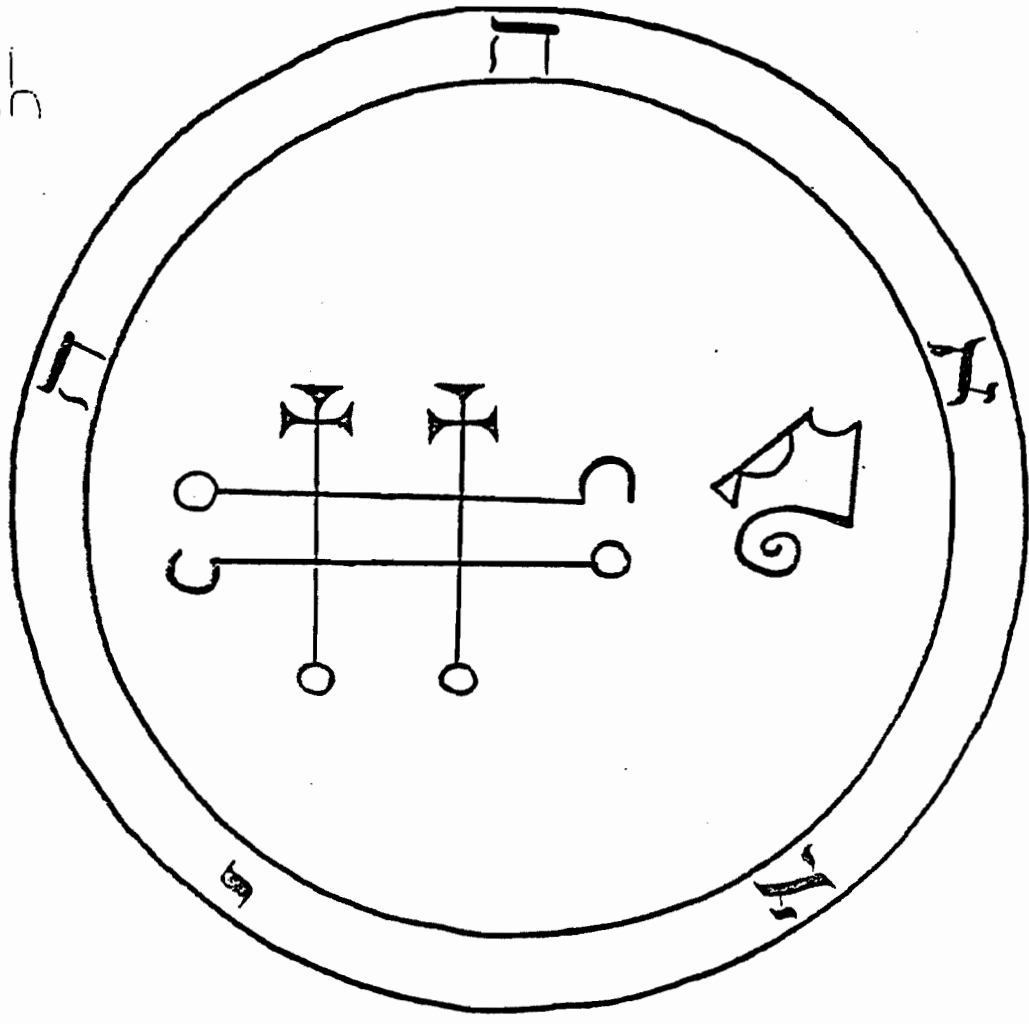

Intnel

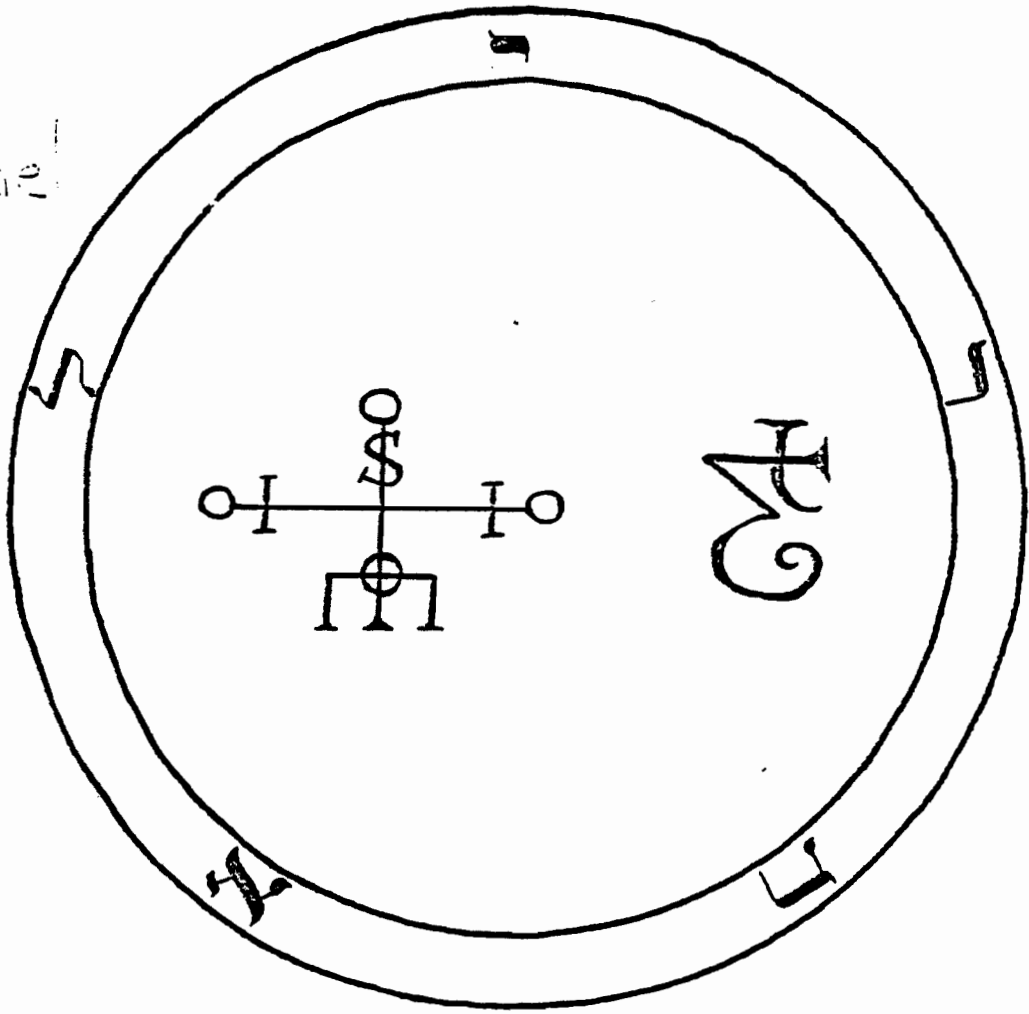

Sehaiah

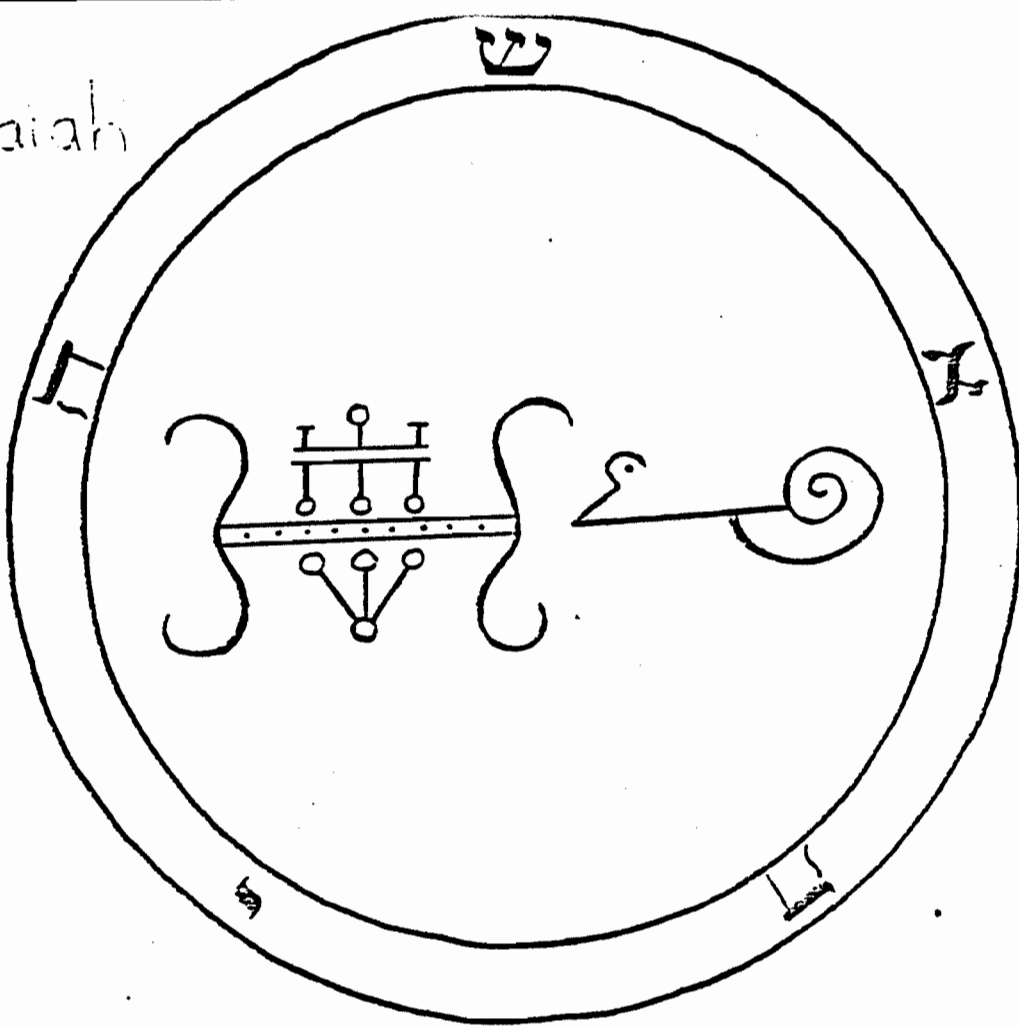

Maya

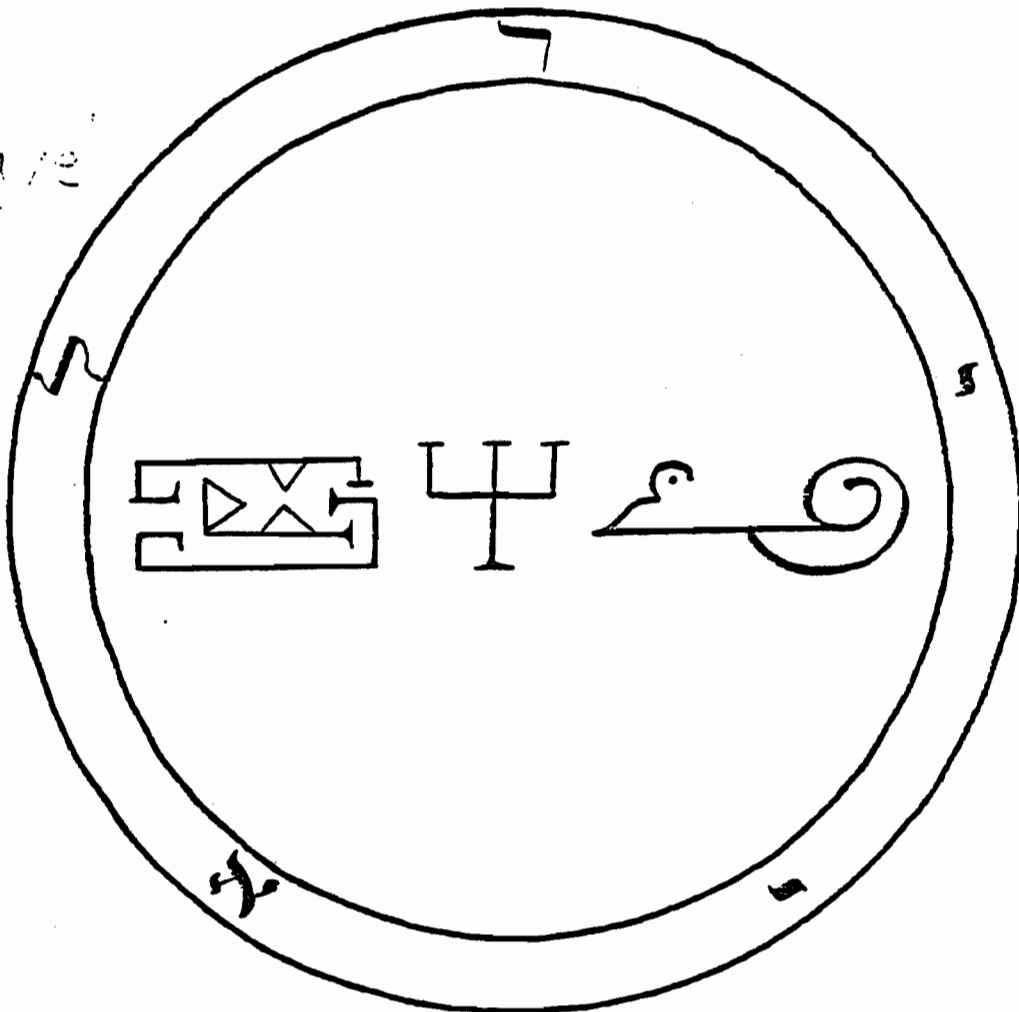

30
Evamel

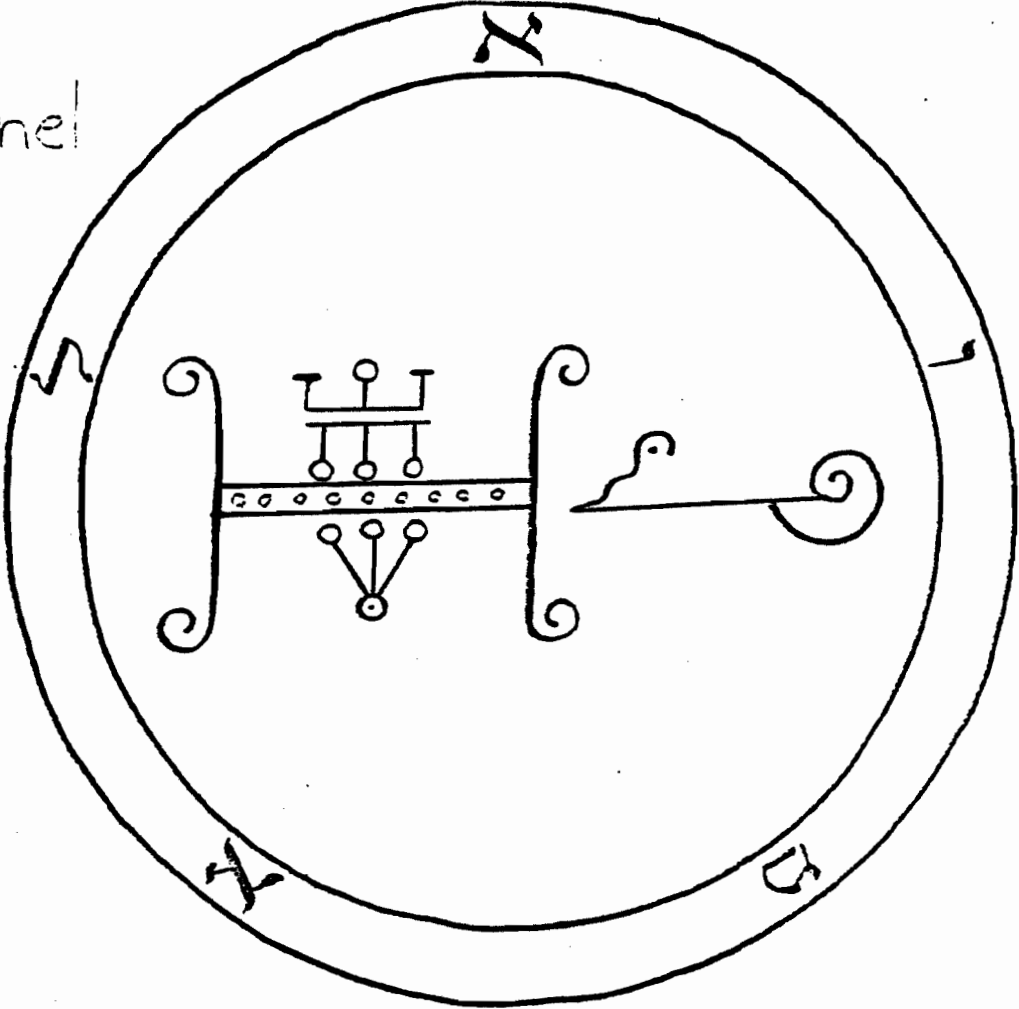

erace

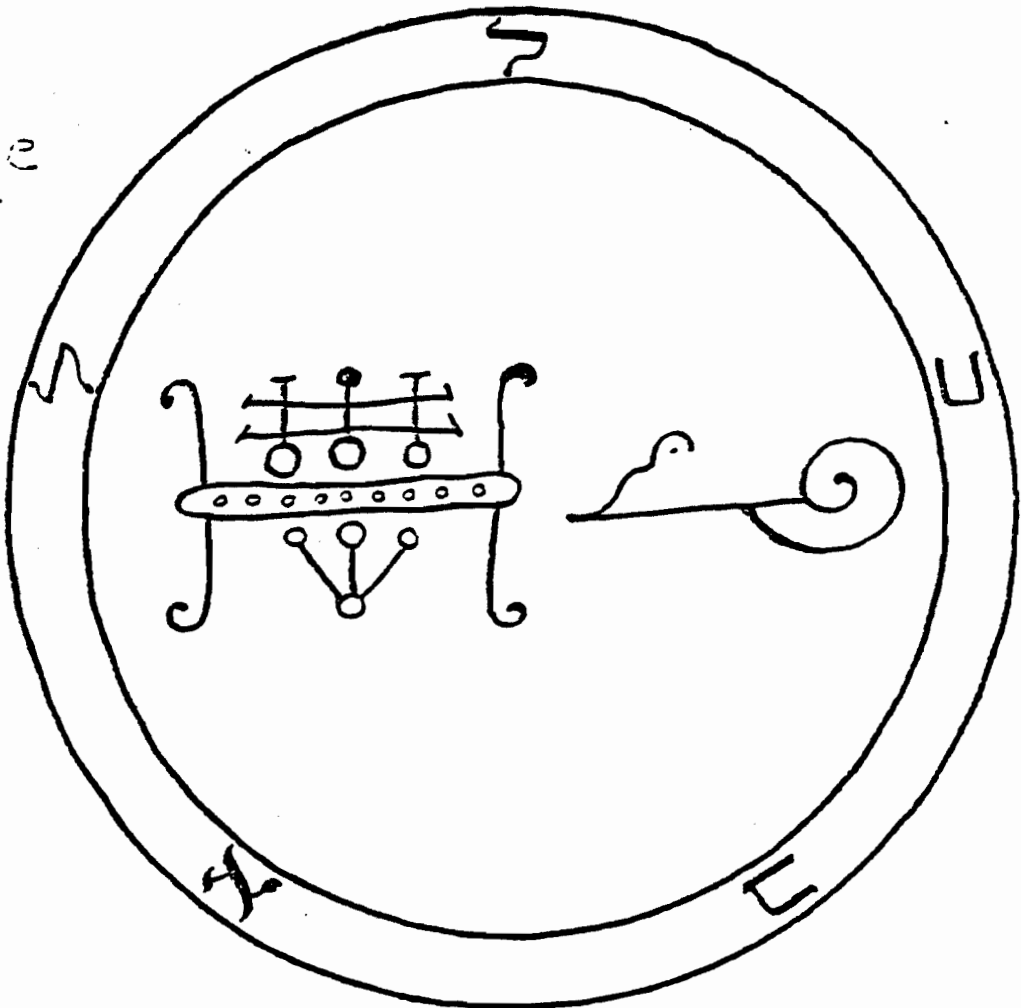

Vesheriah

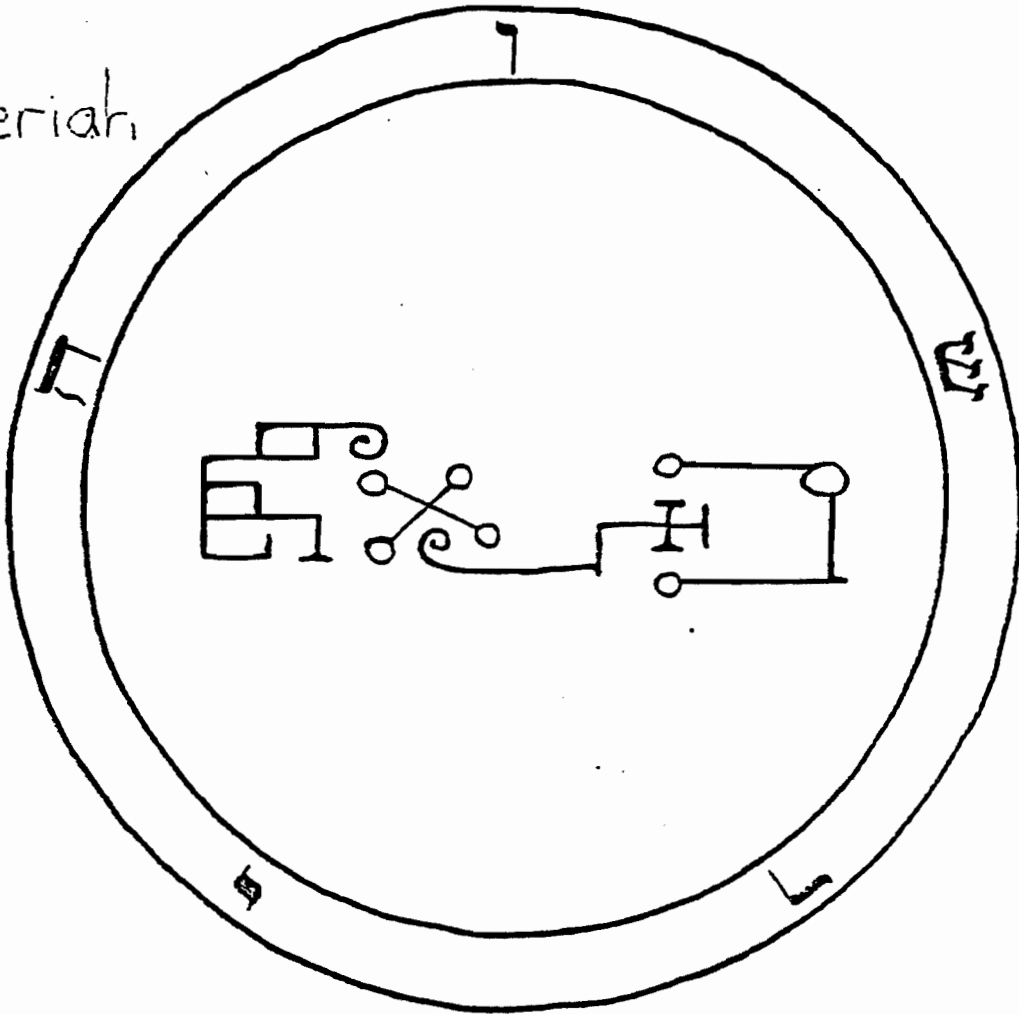

Yechuniah

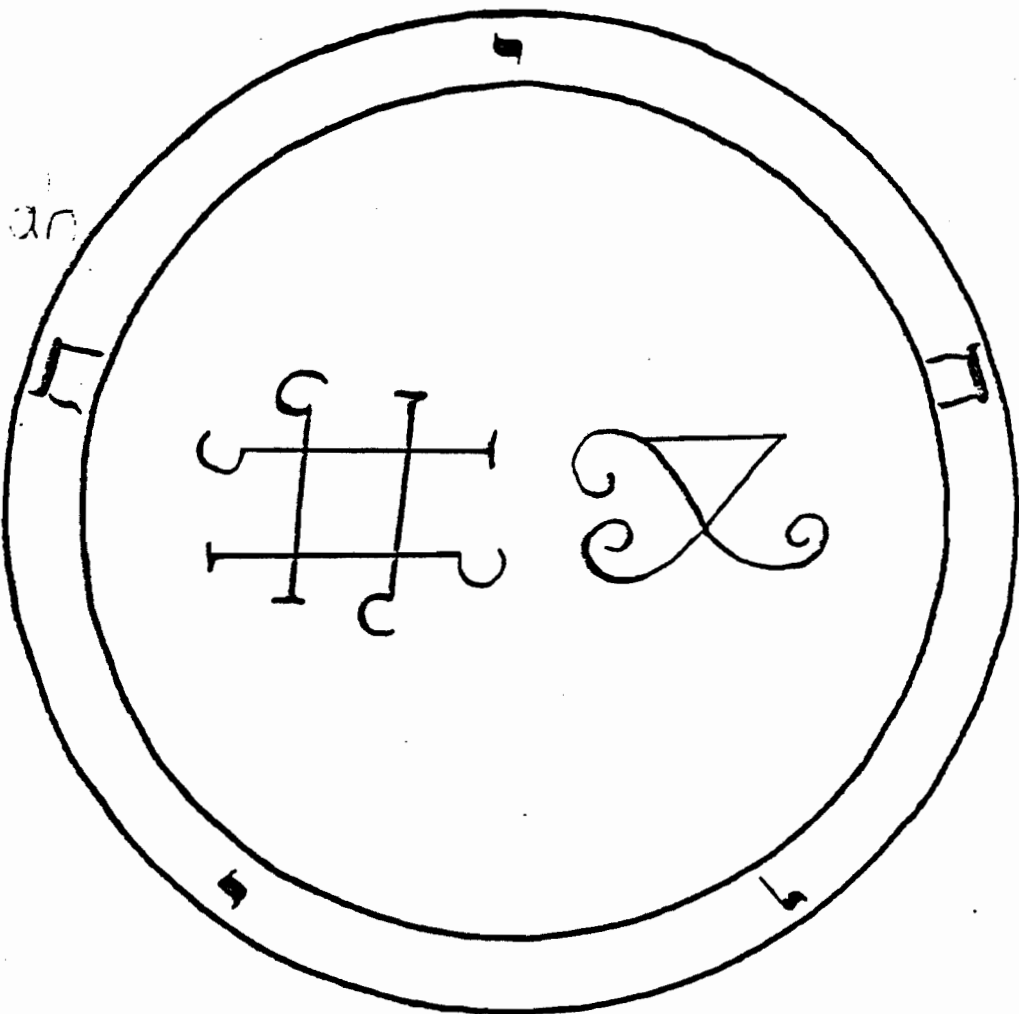

Lehahaiah

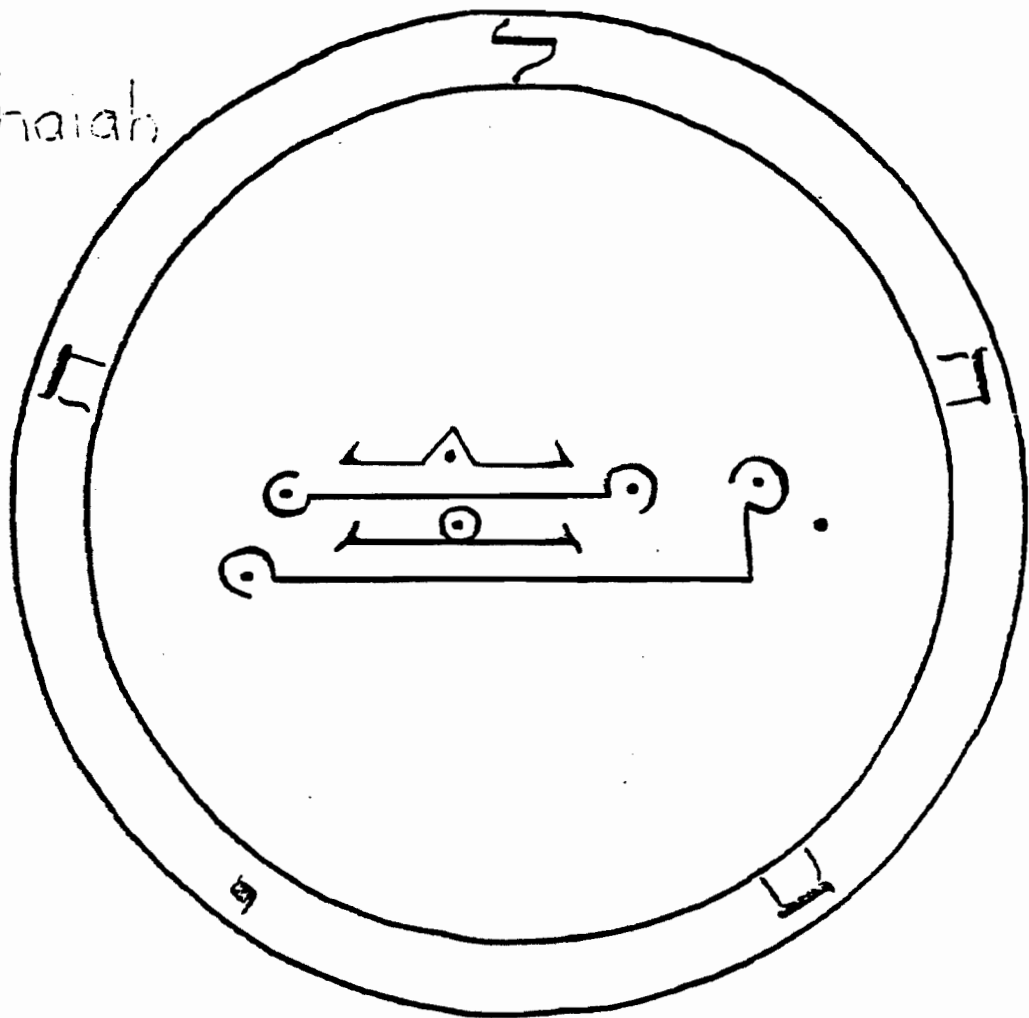

Kerangka

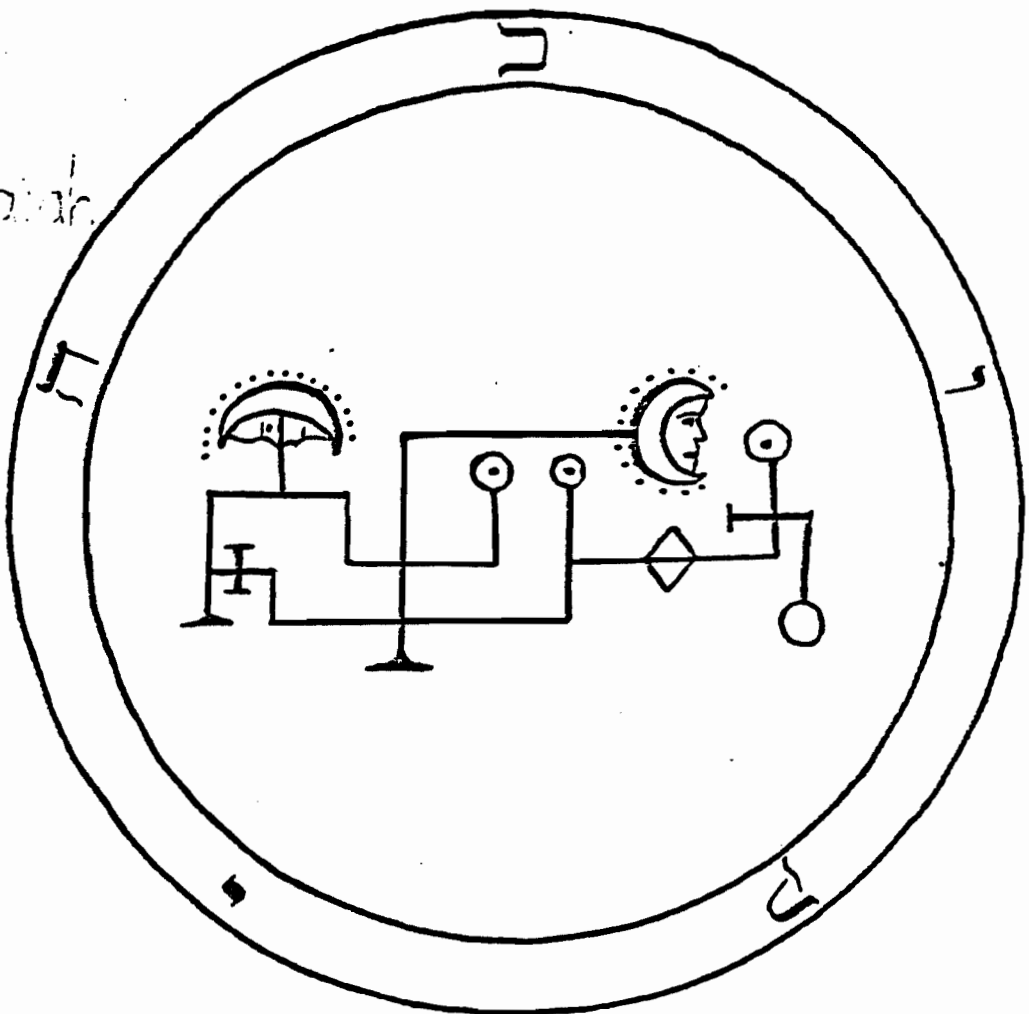

36

Mendiel

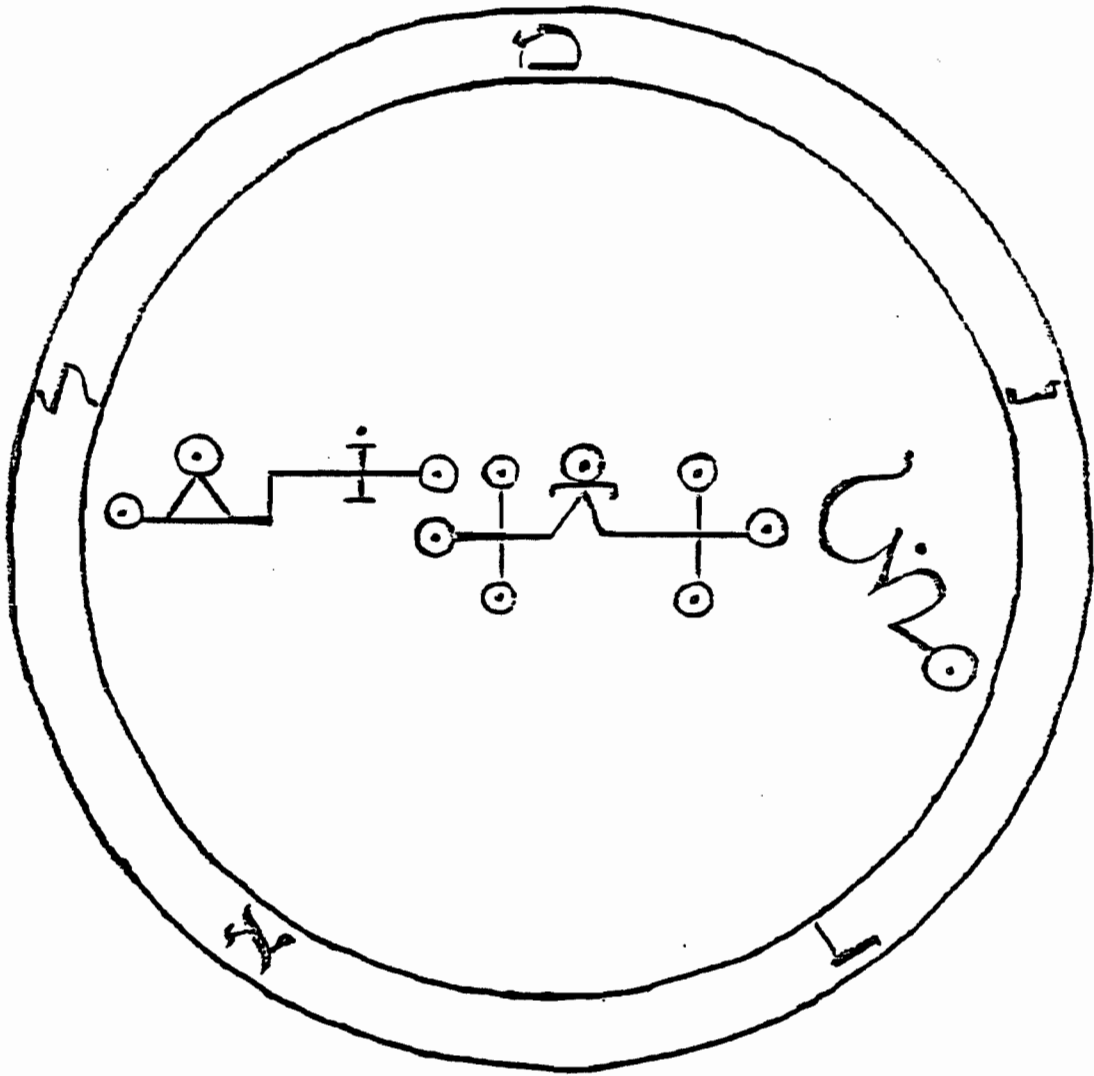

Anael

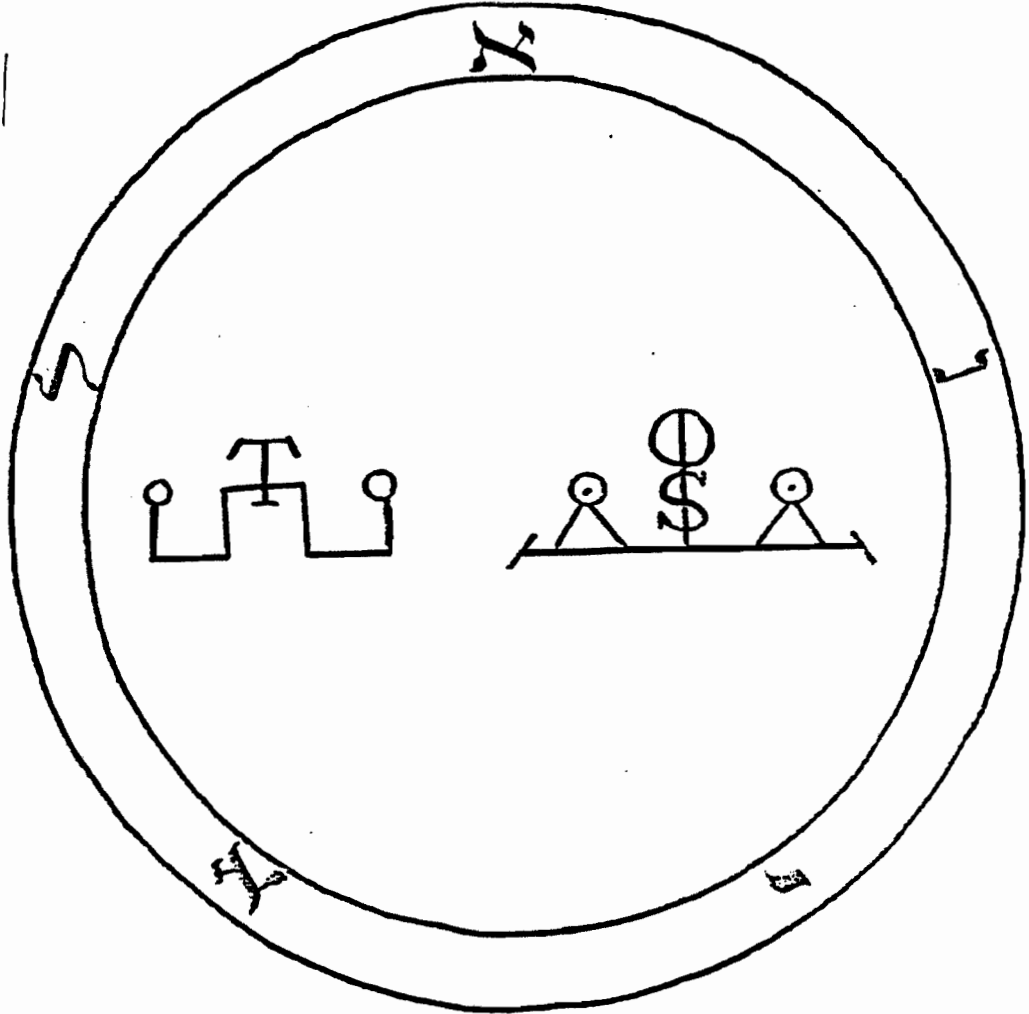

Chaamir

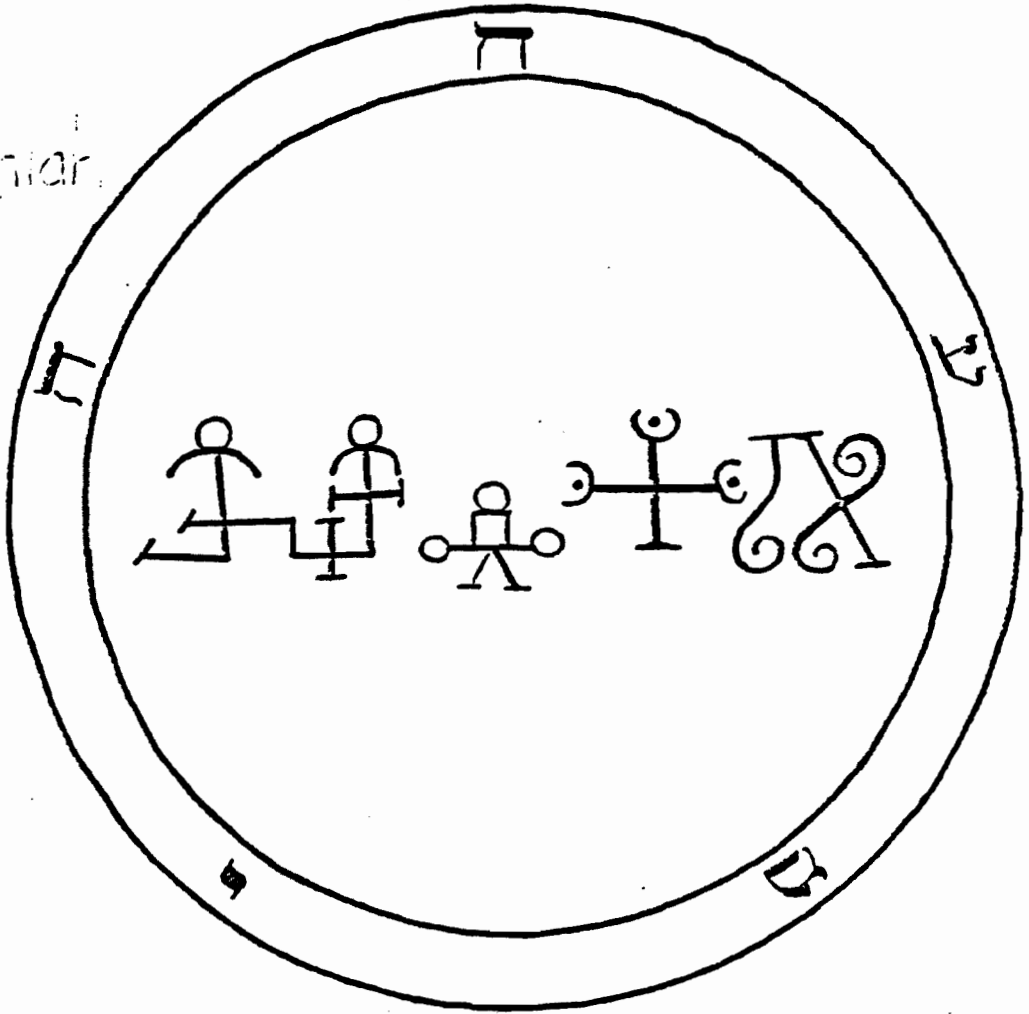

Reheael

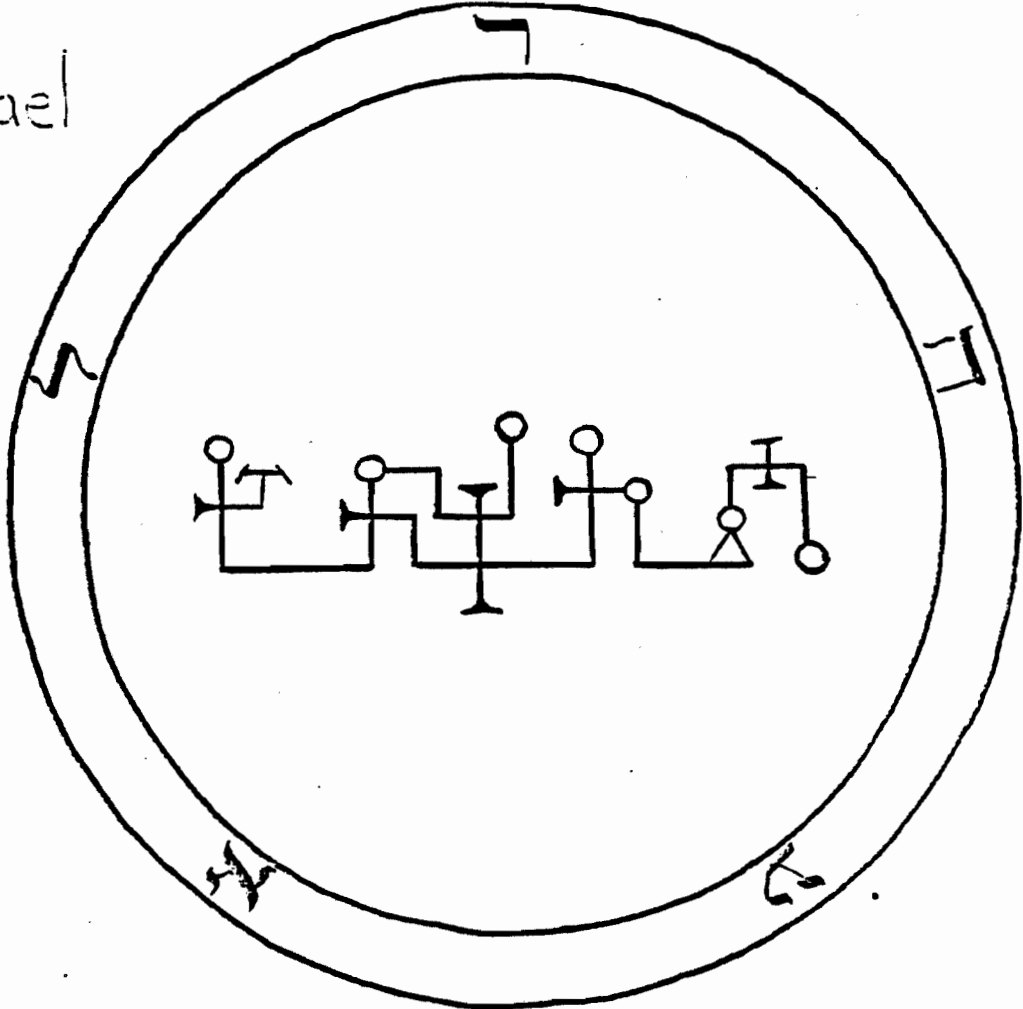

Yeizael

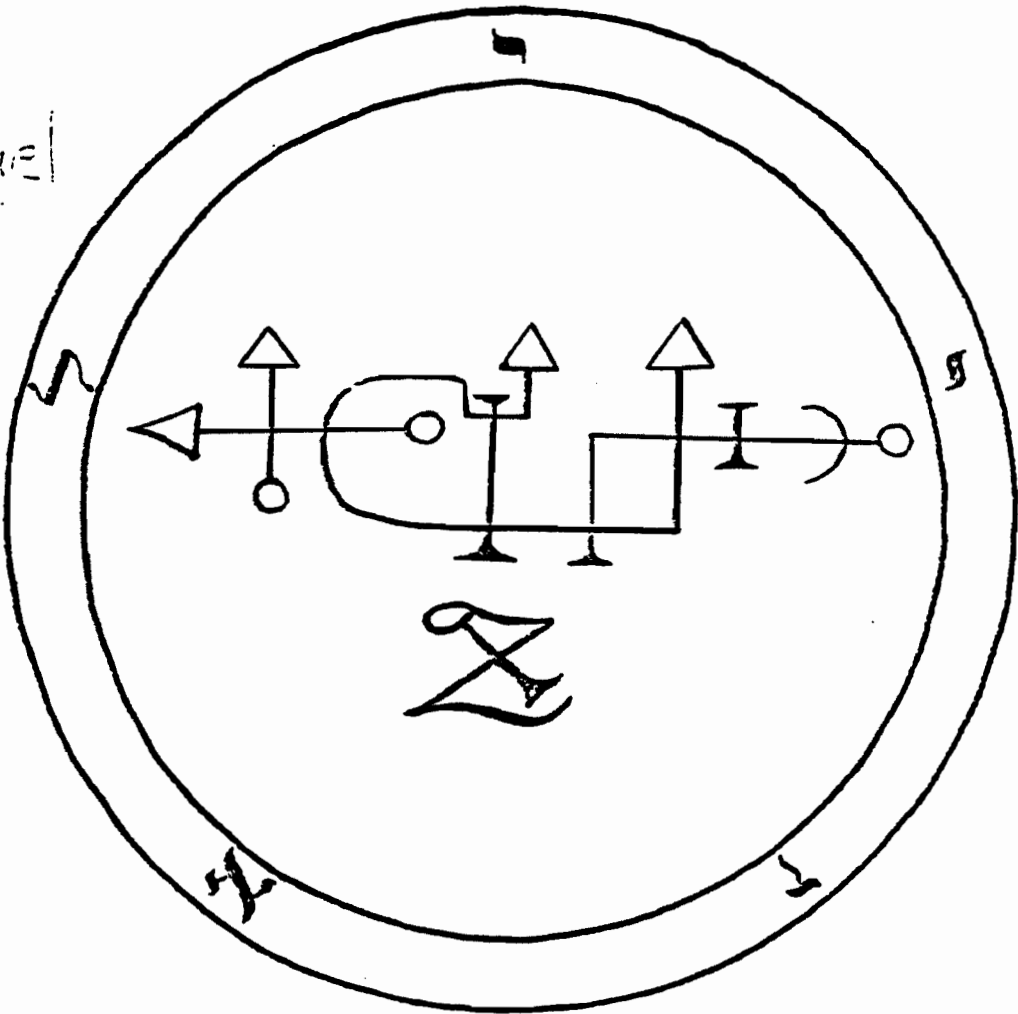

Himmel

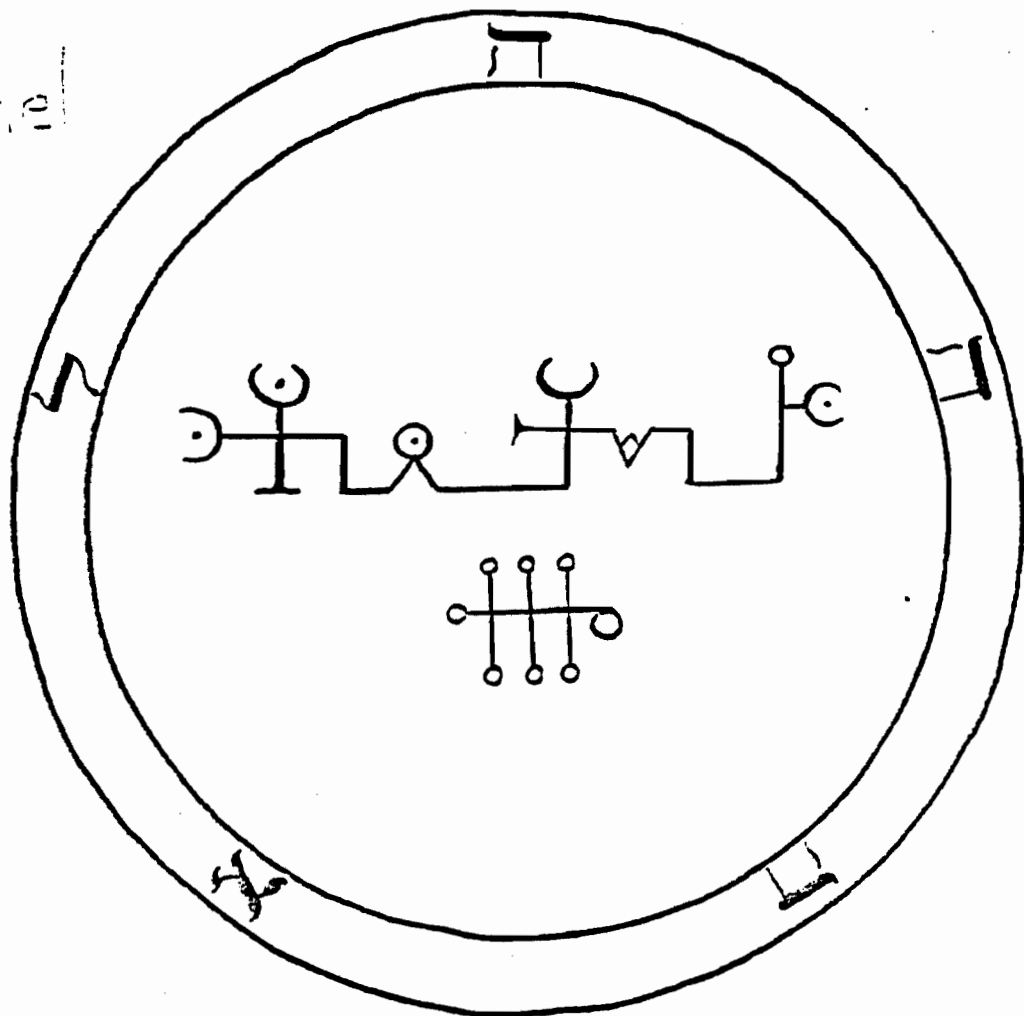

Land

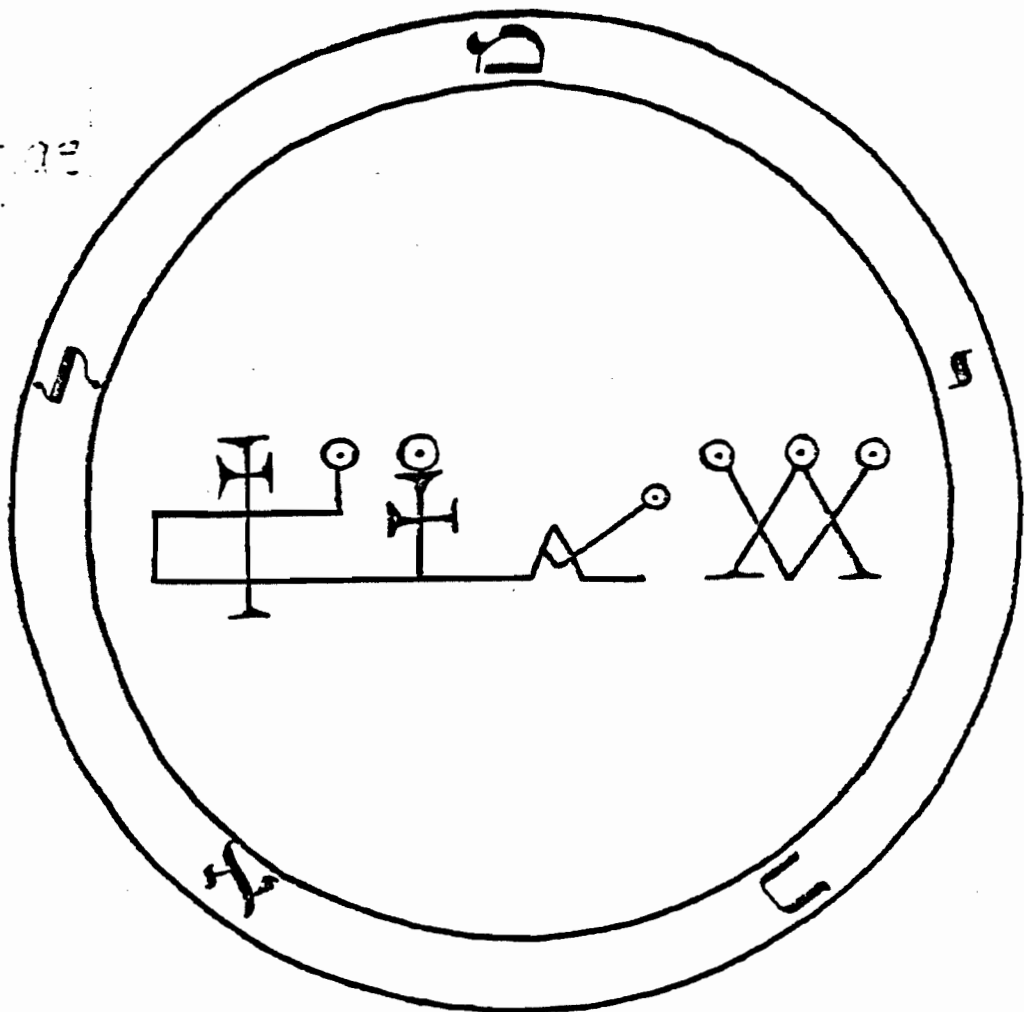

3 Vavaliat

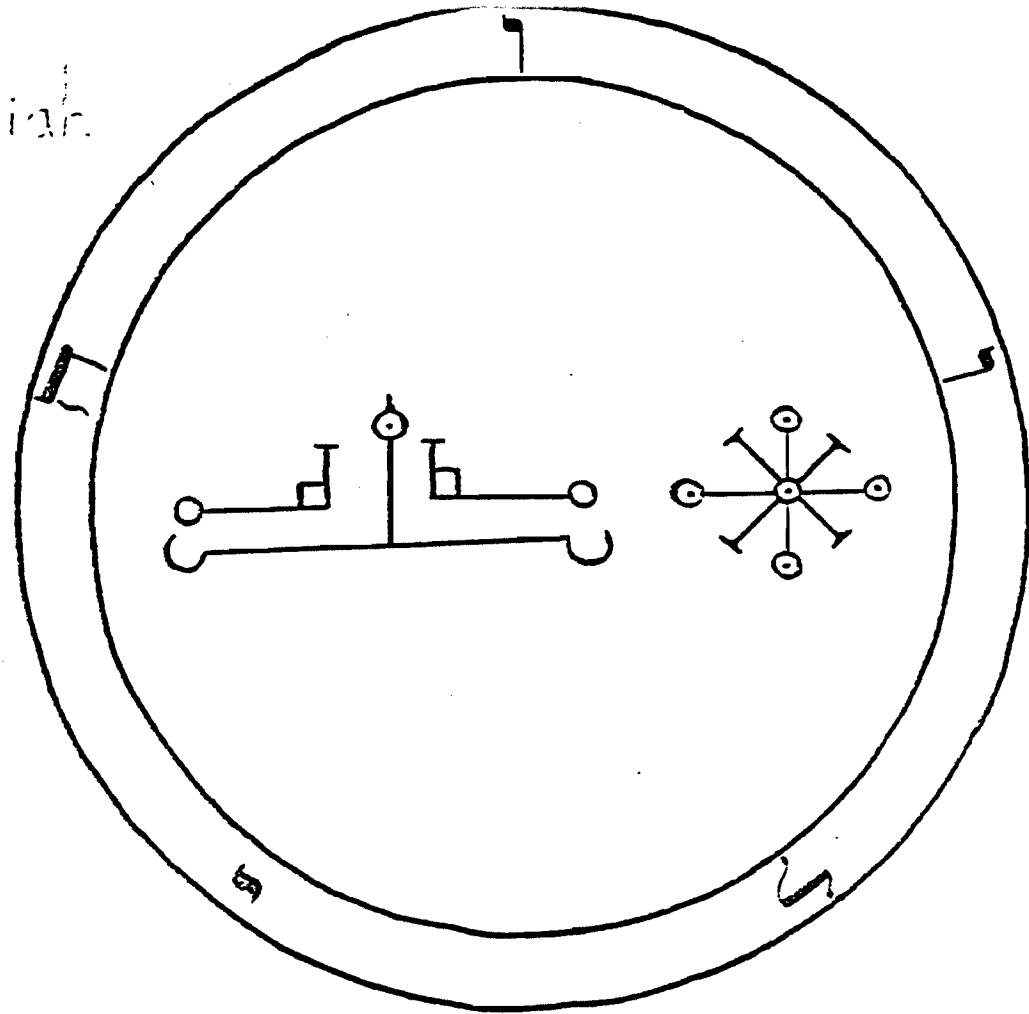

4 Ilarab

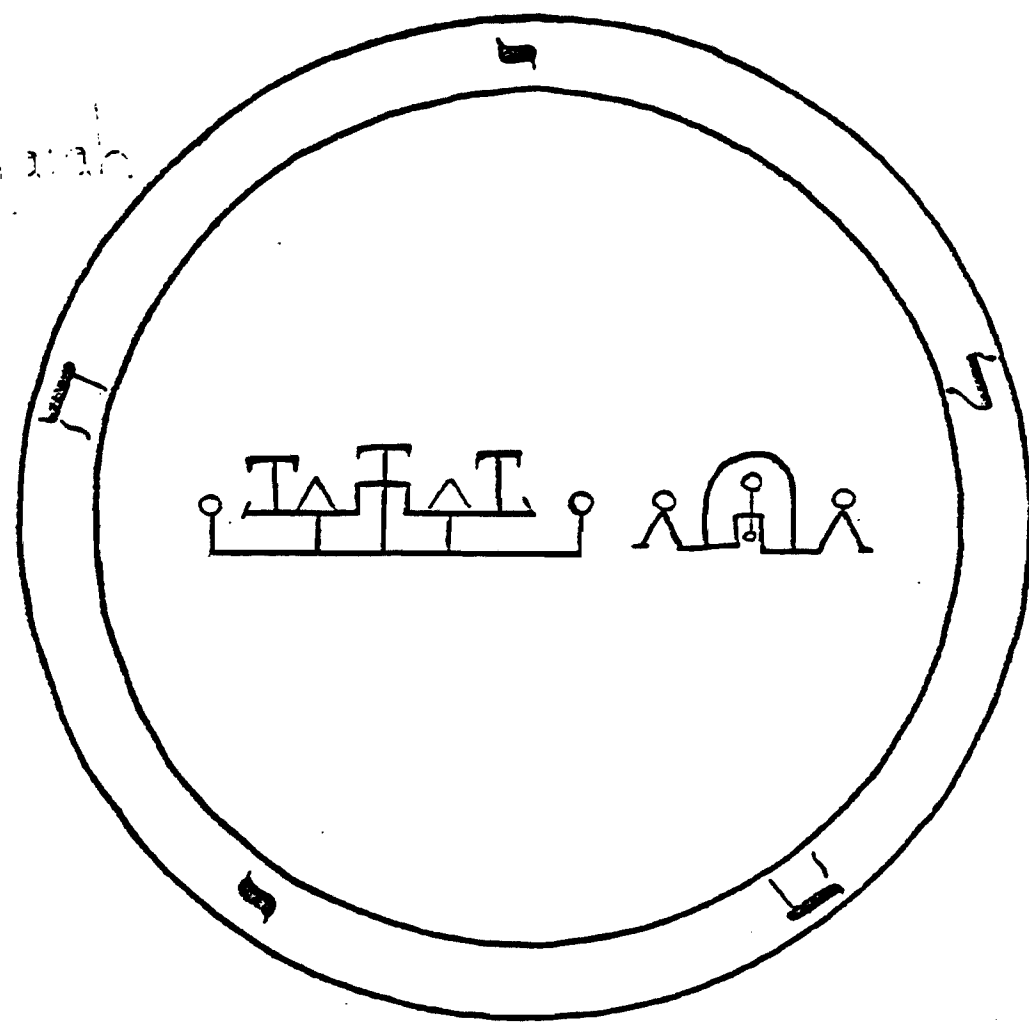

45 Saclarah

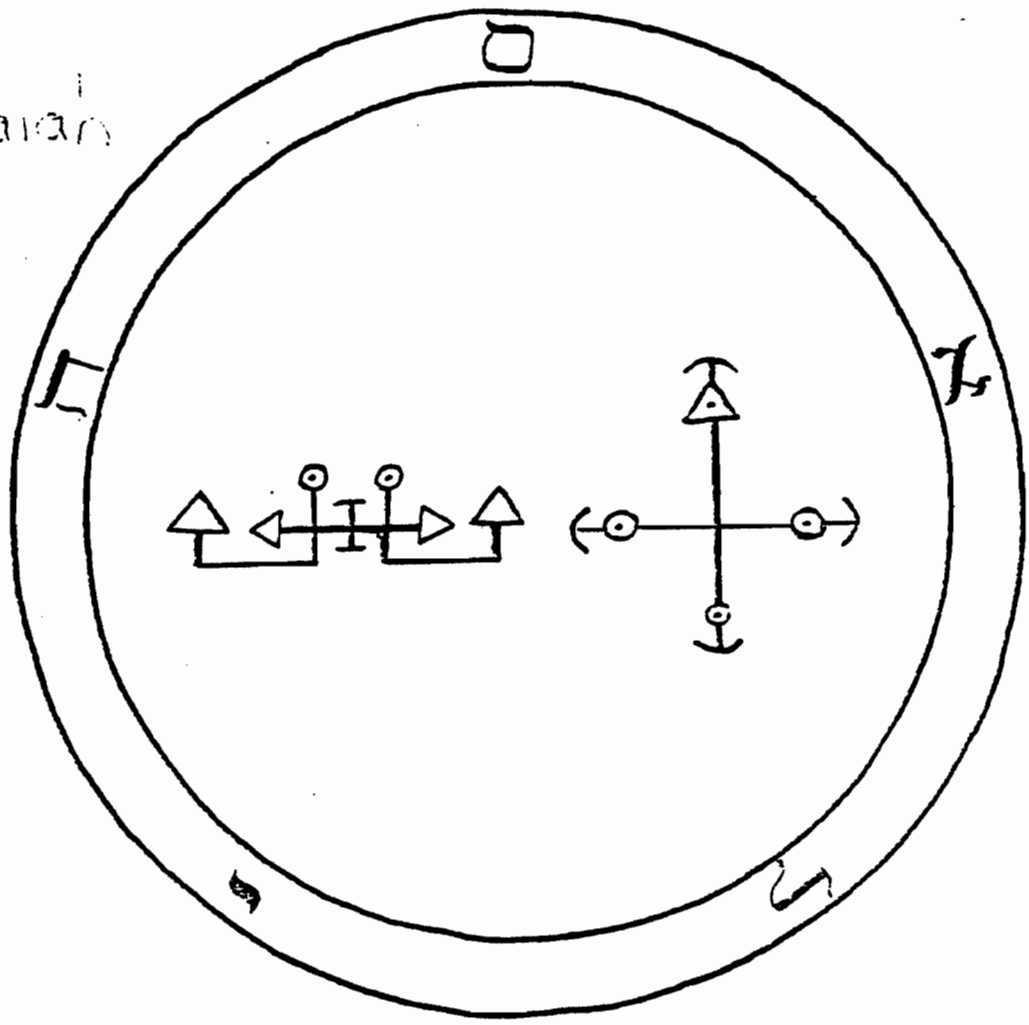

46 Igharahel

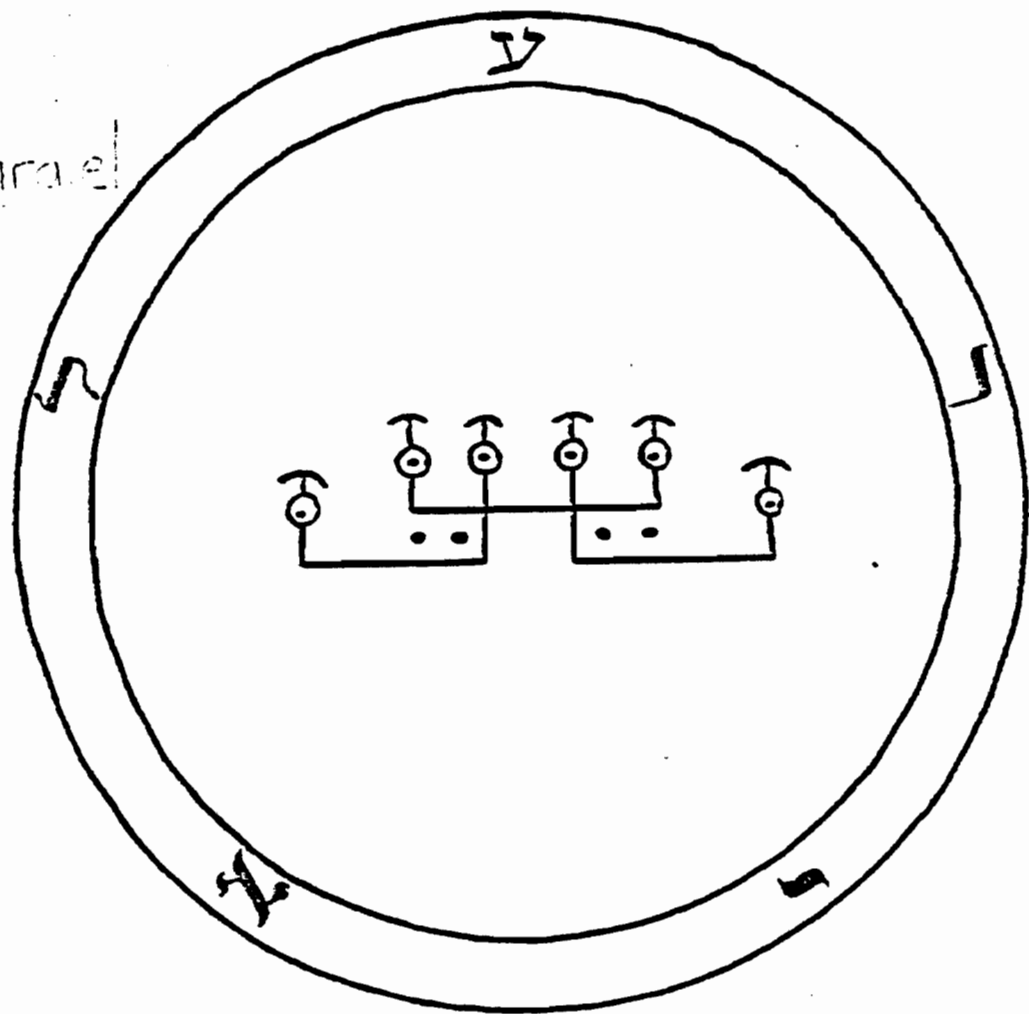

Aslaiah

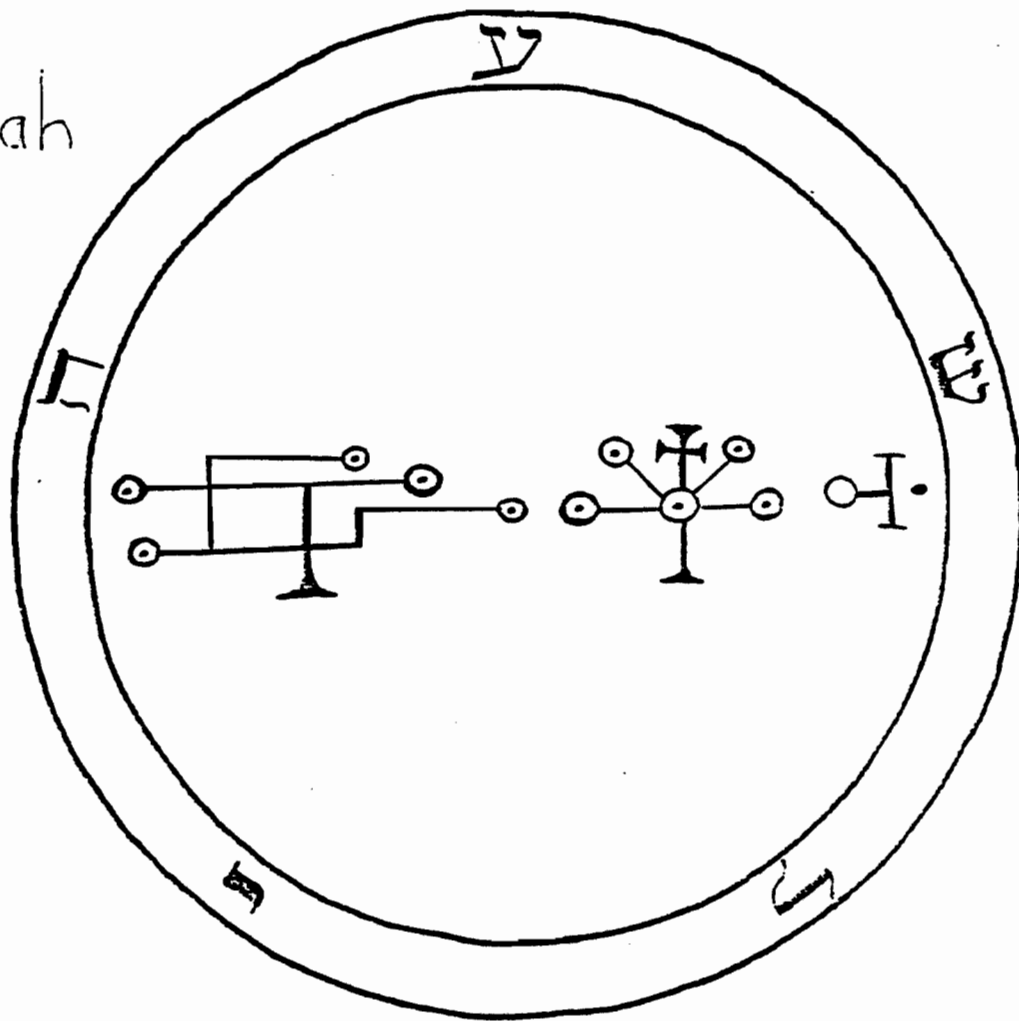

Michel

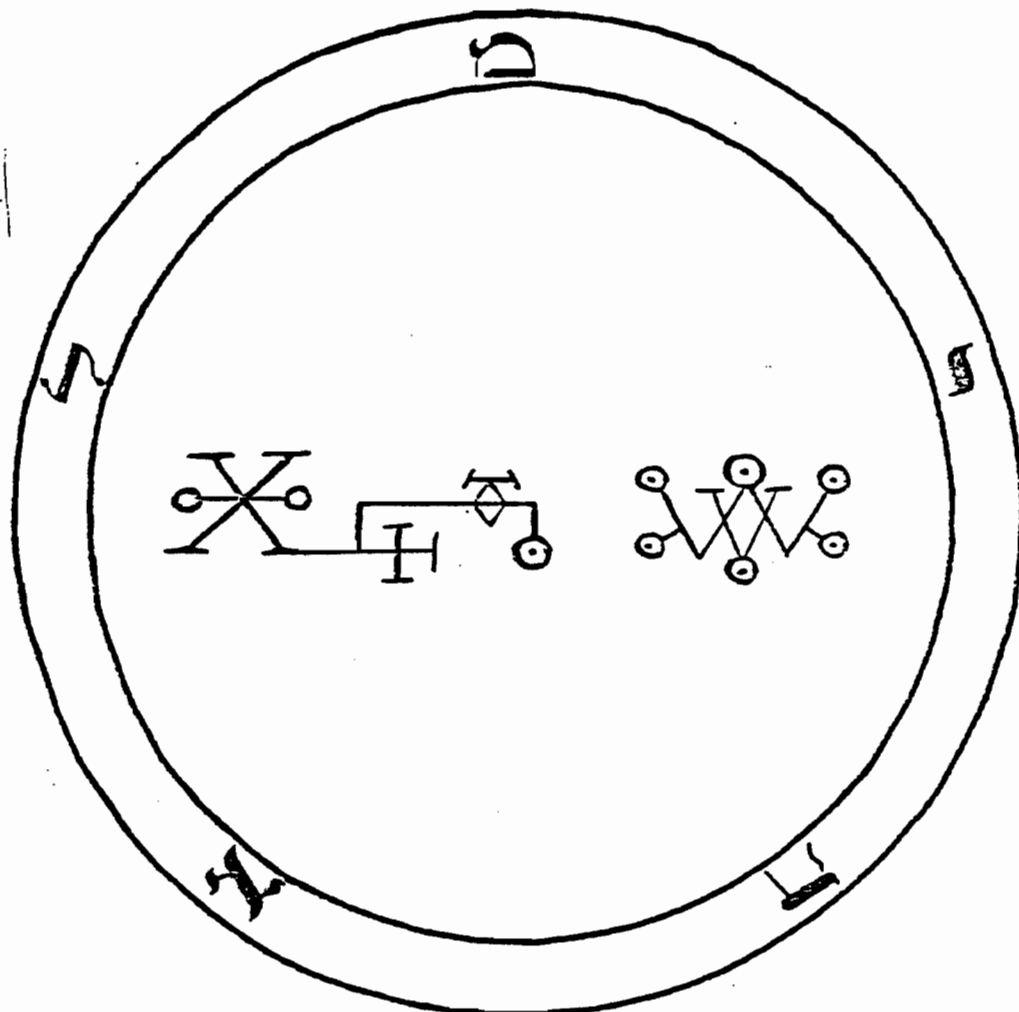

Uhauei

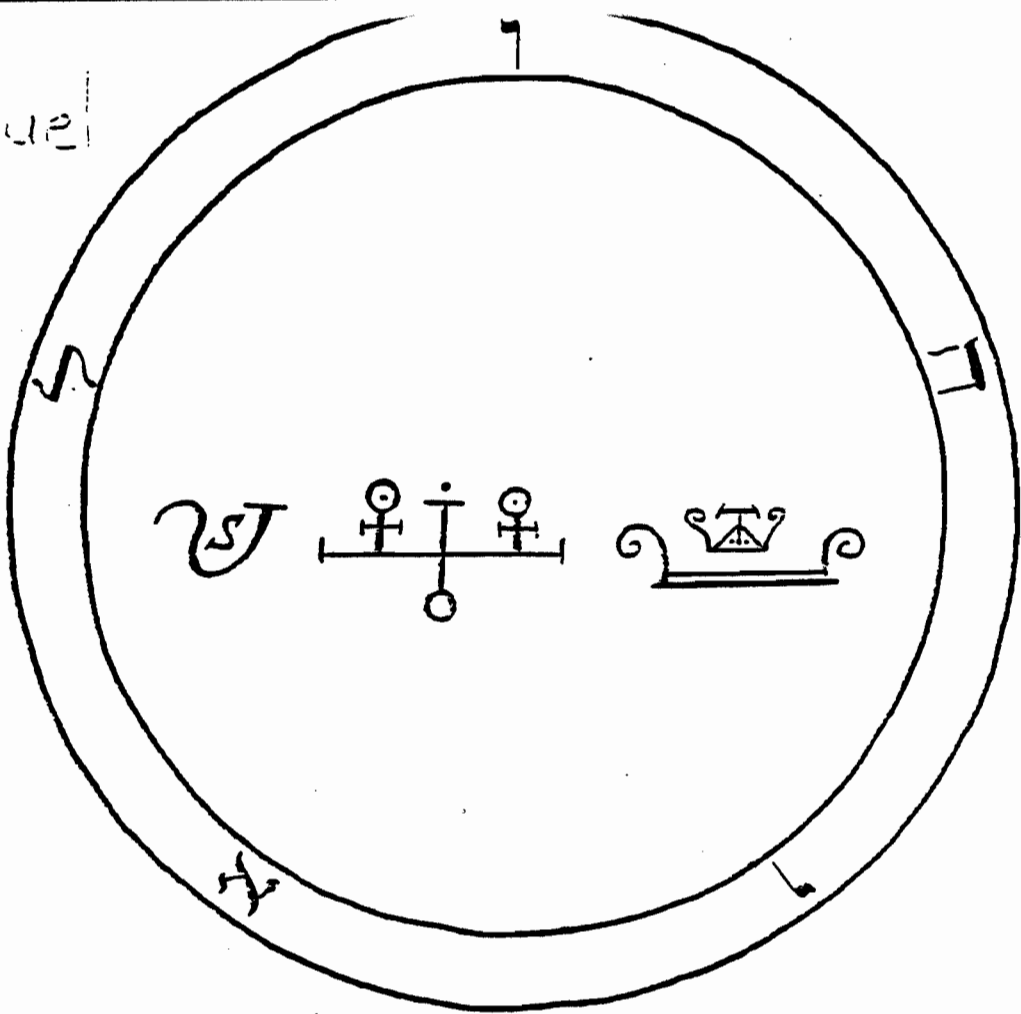

Deneyle

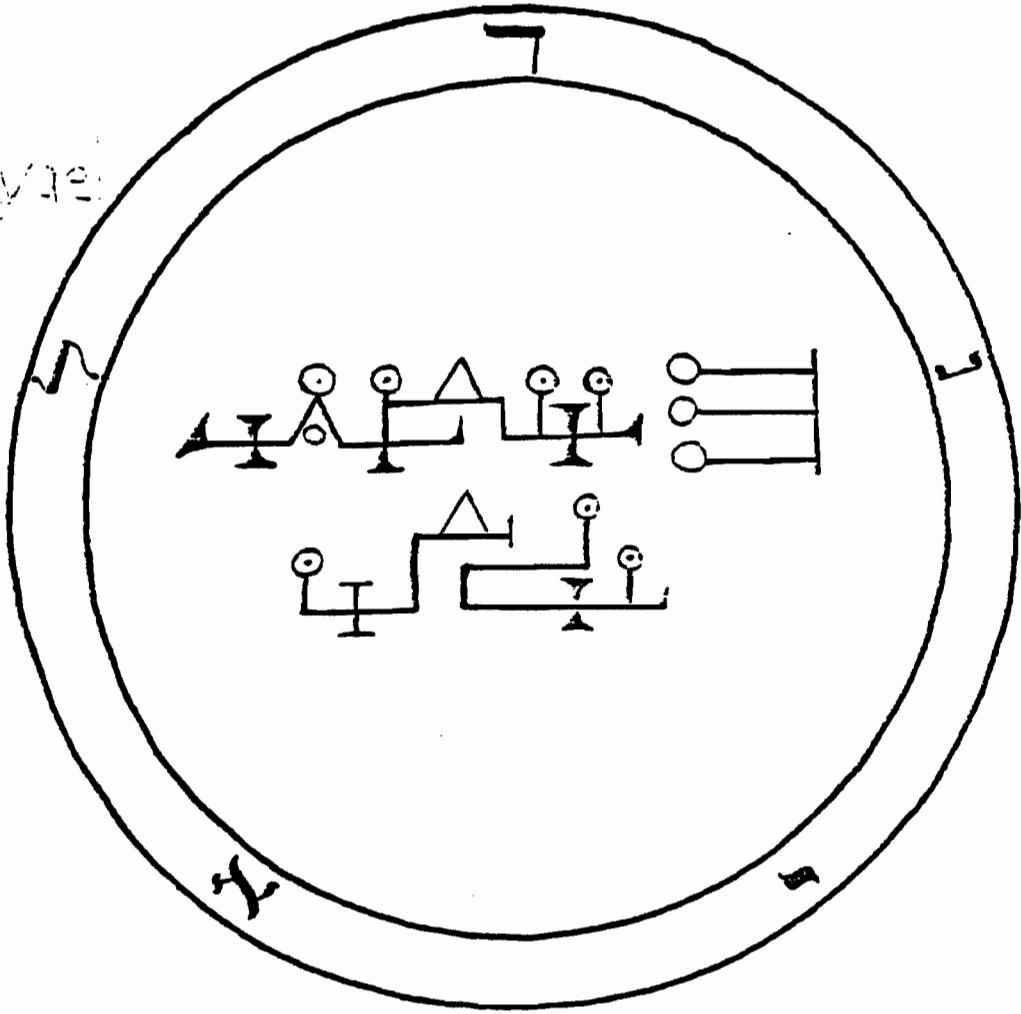

9) Hechasheret,

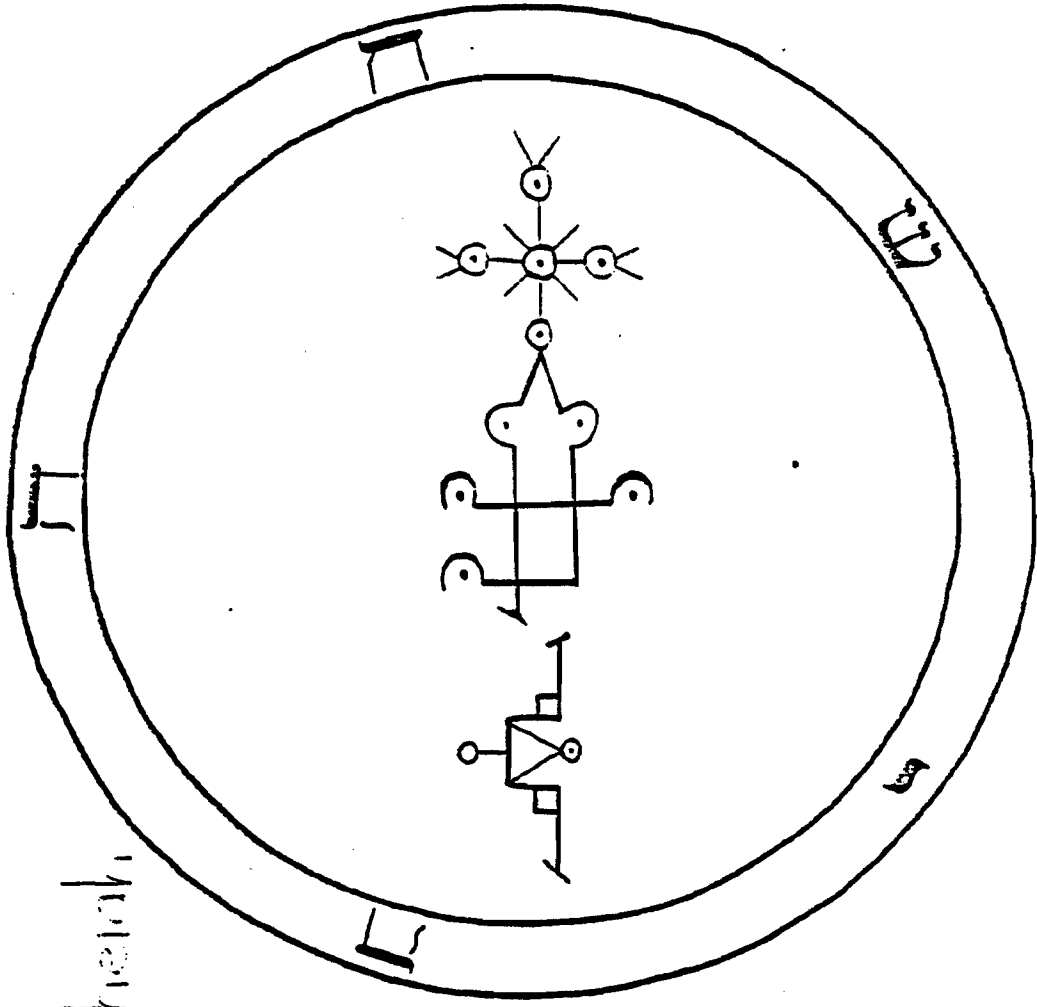

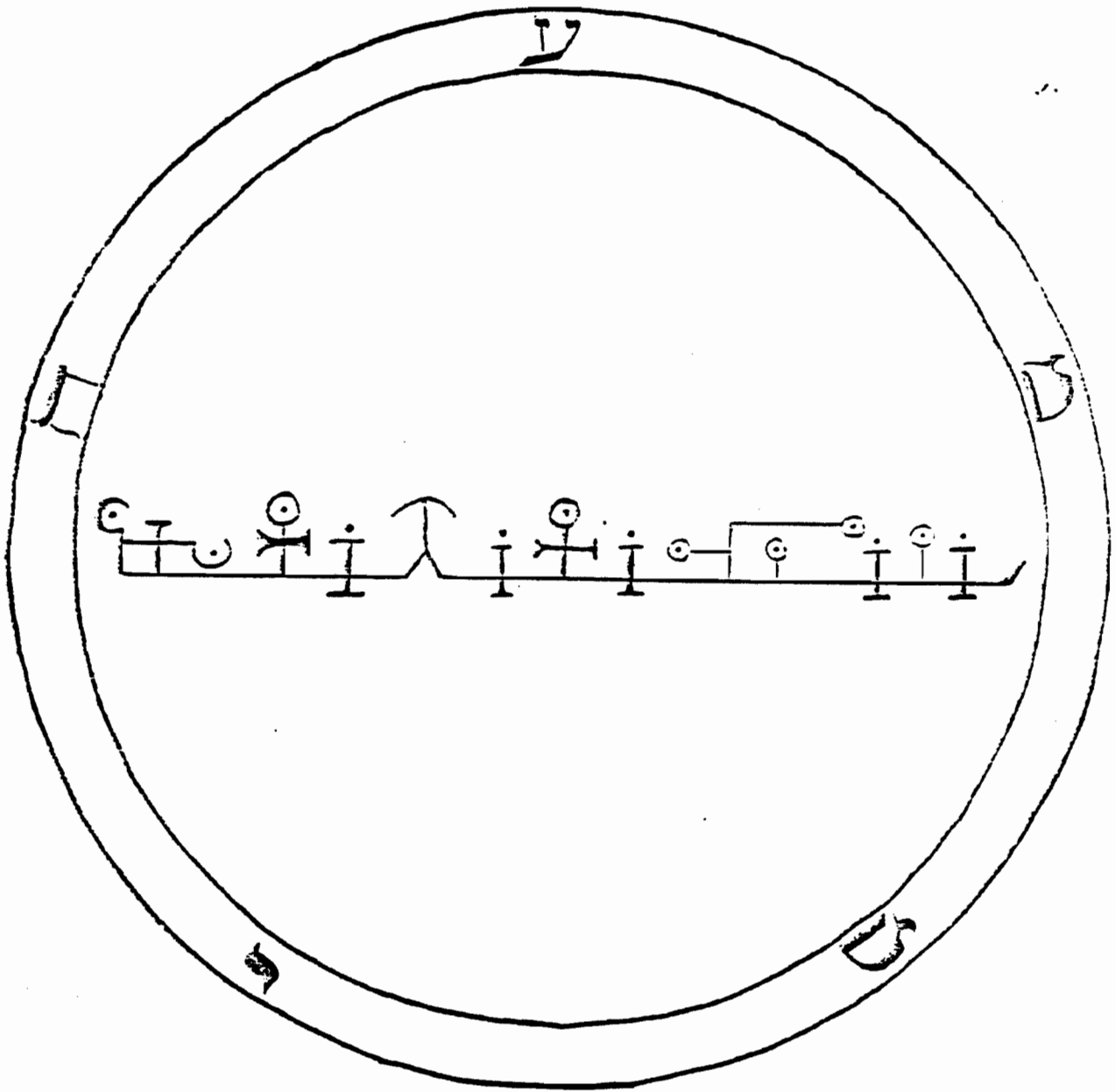

55. Mibahar

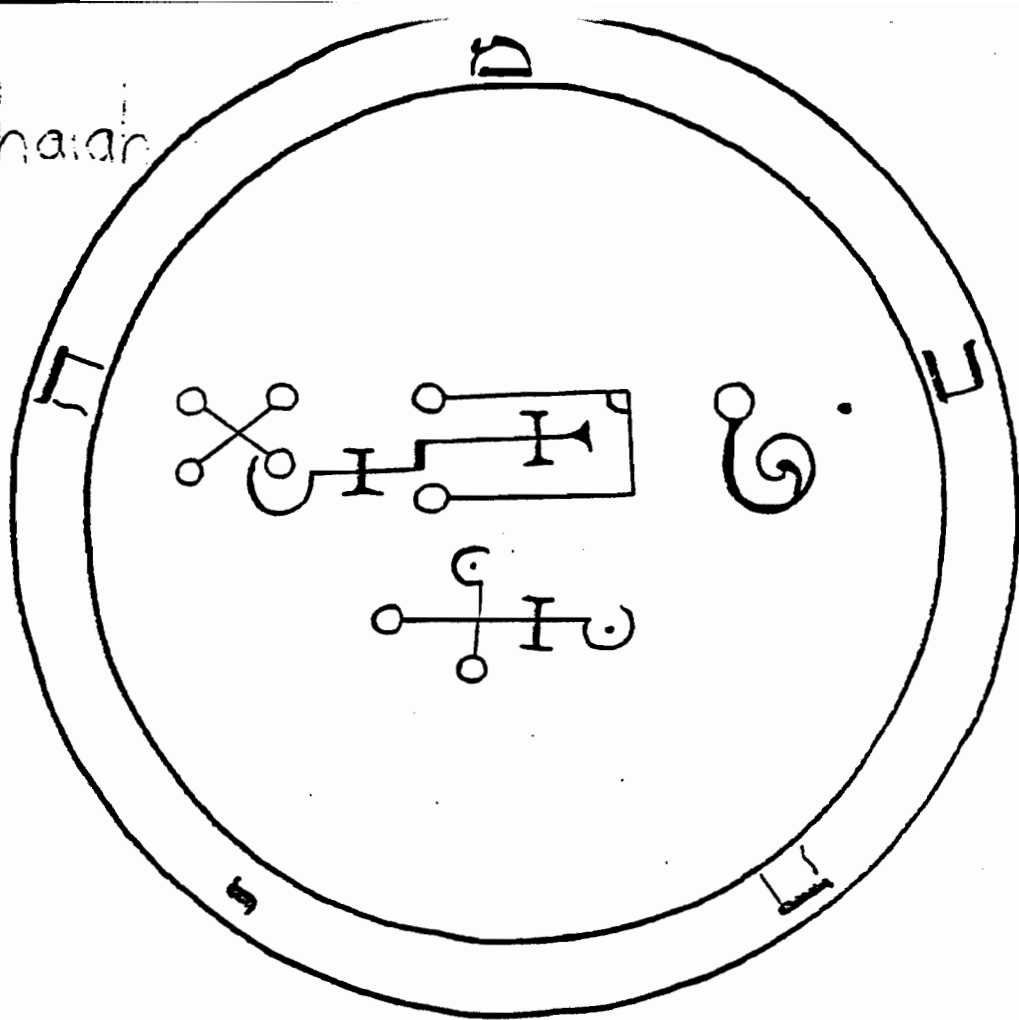

56. Mibahar

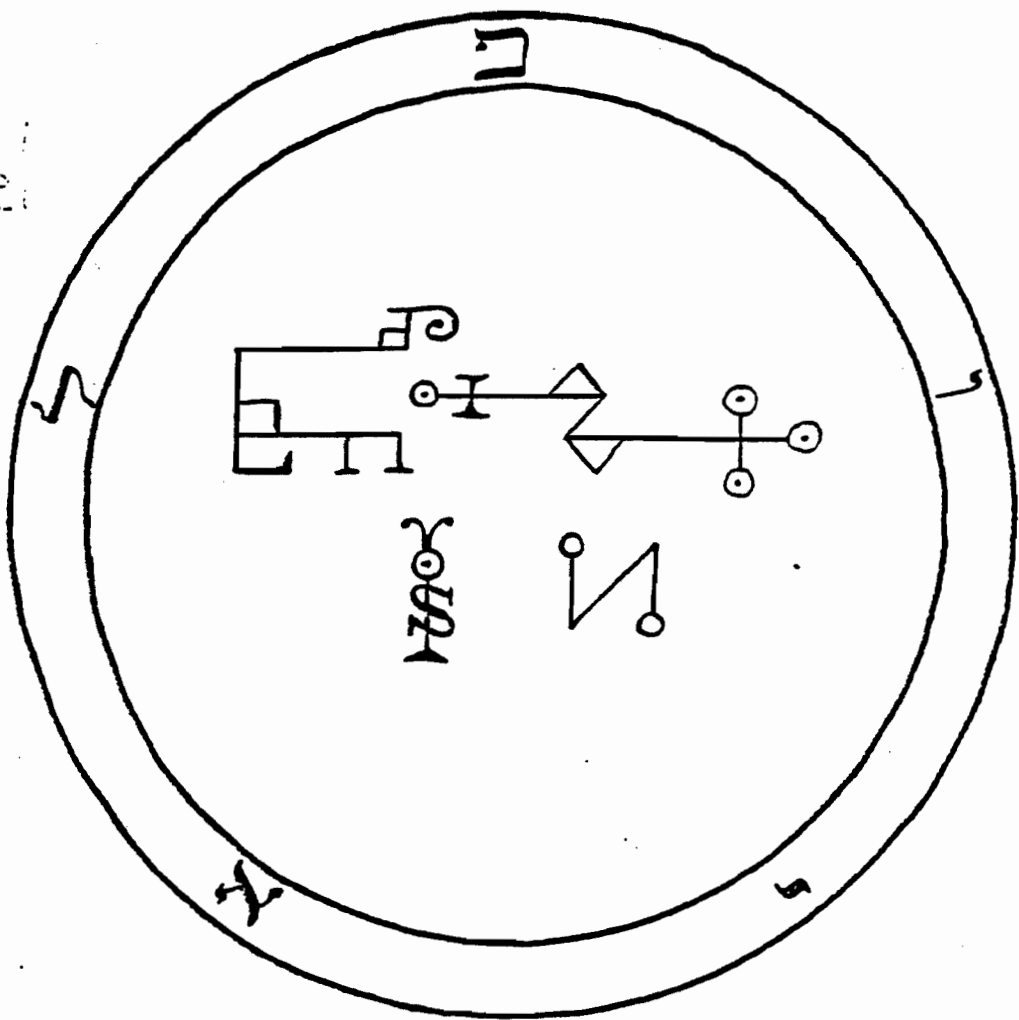

Nemamiah

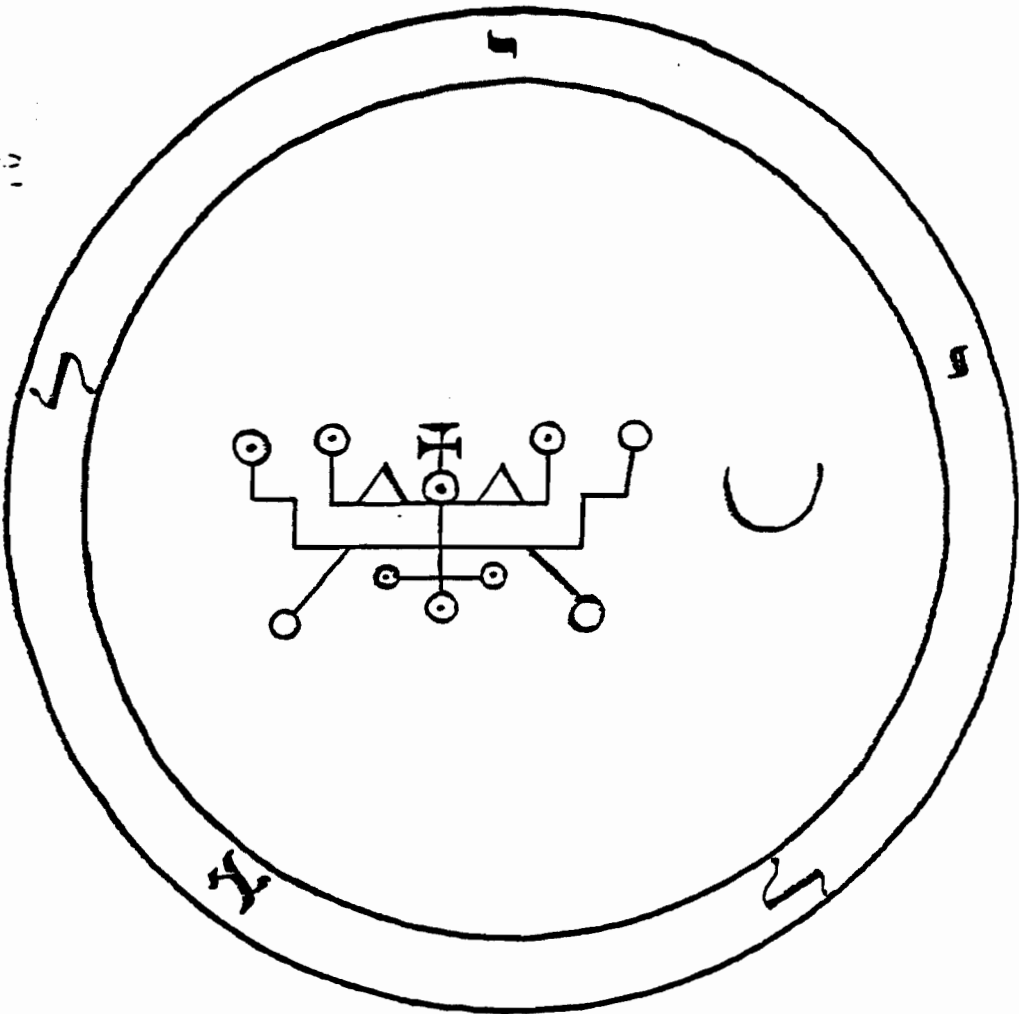
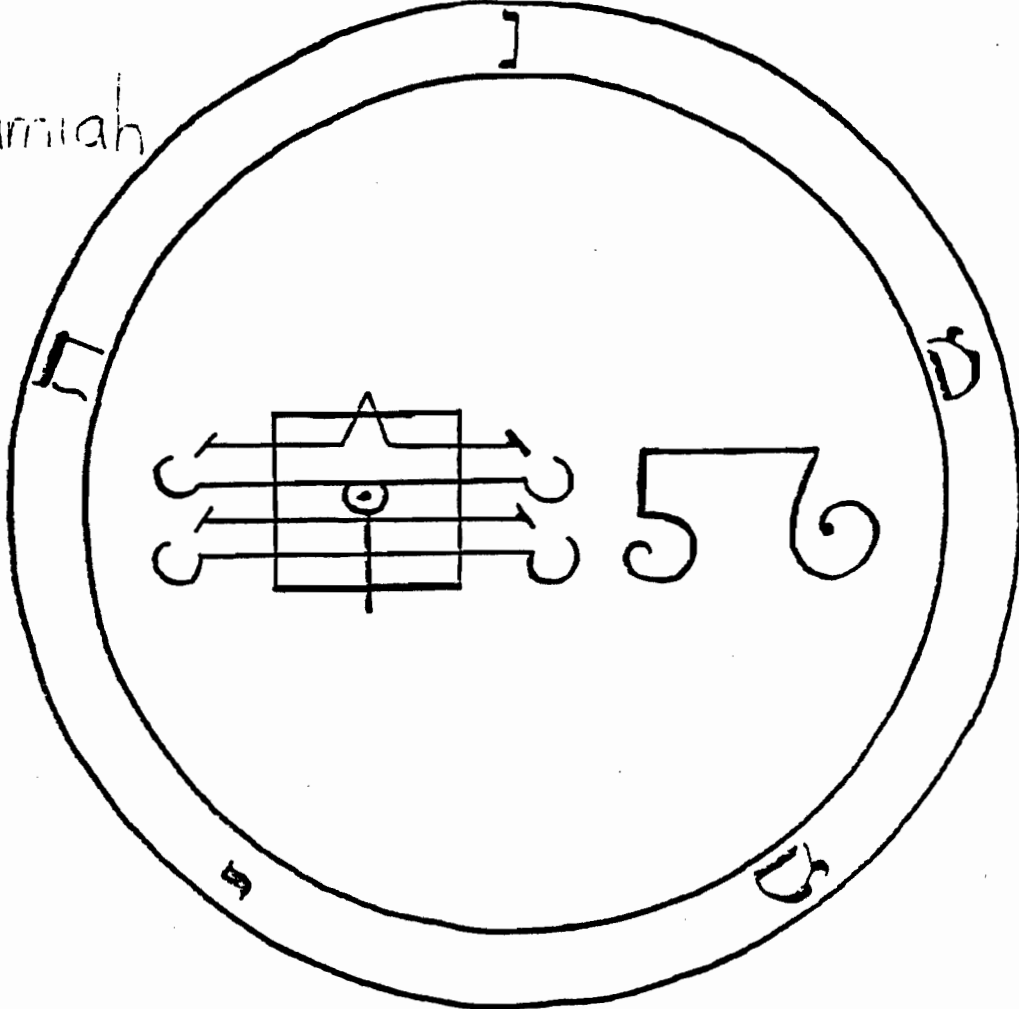

Herodotus

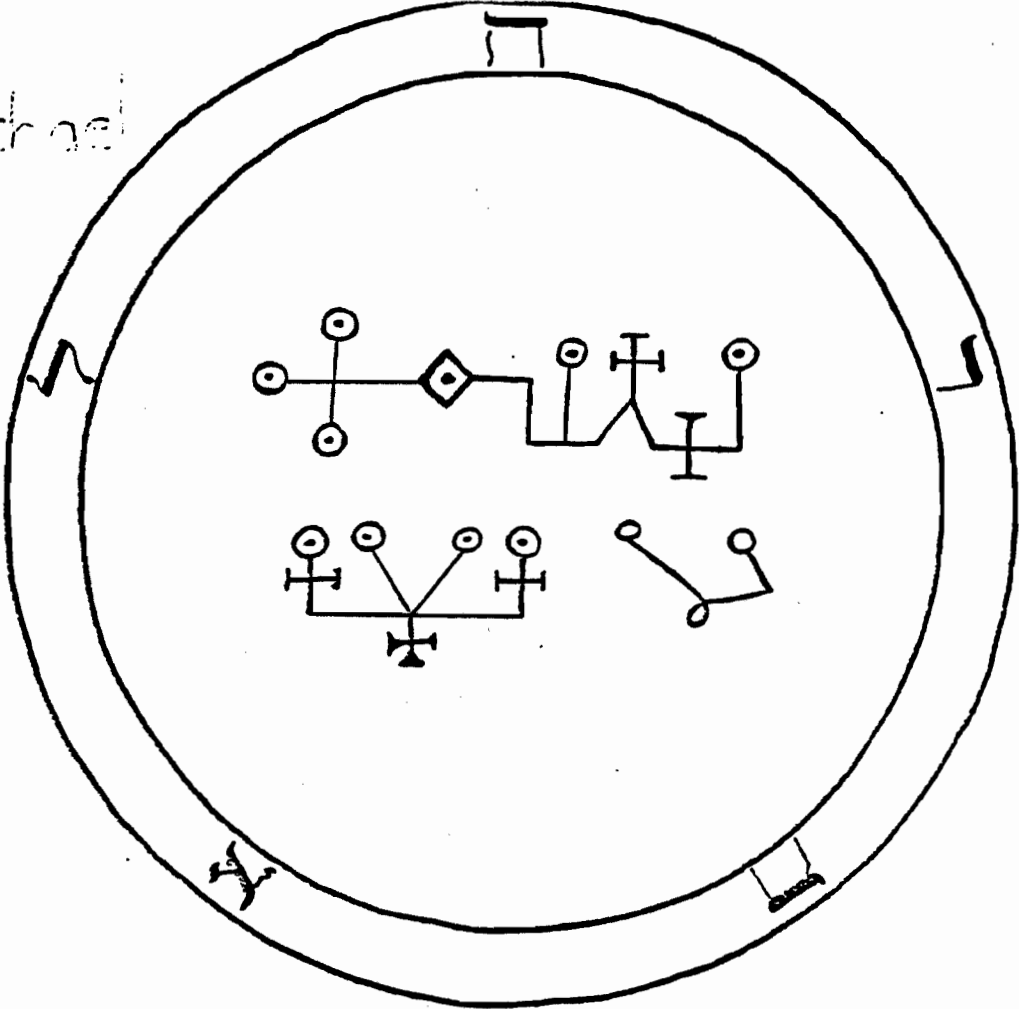

Herodotus

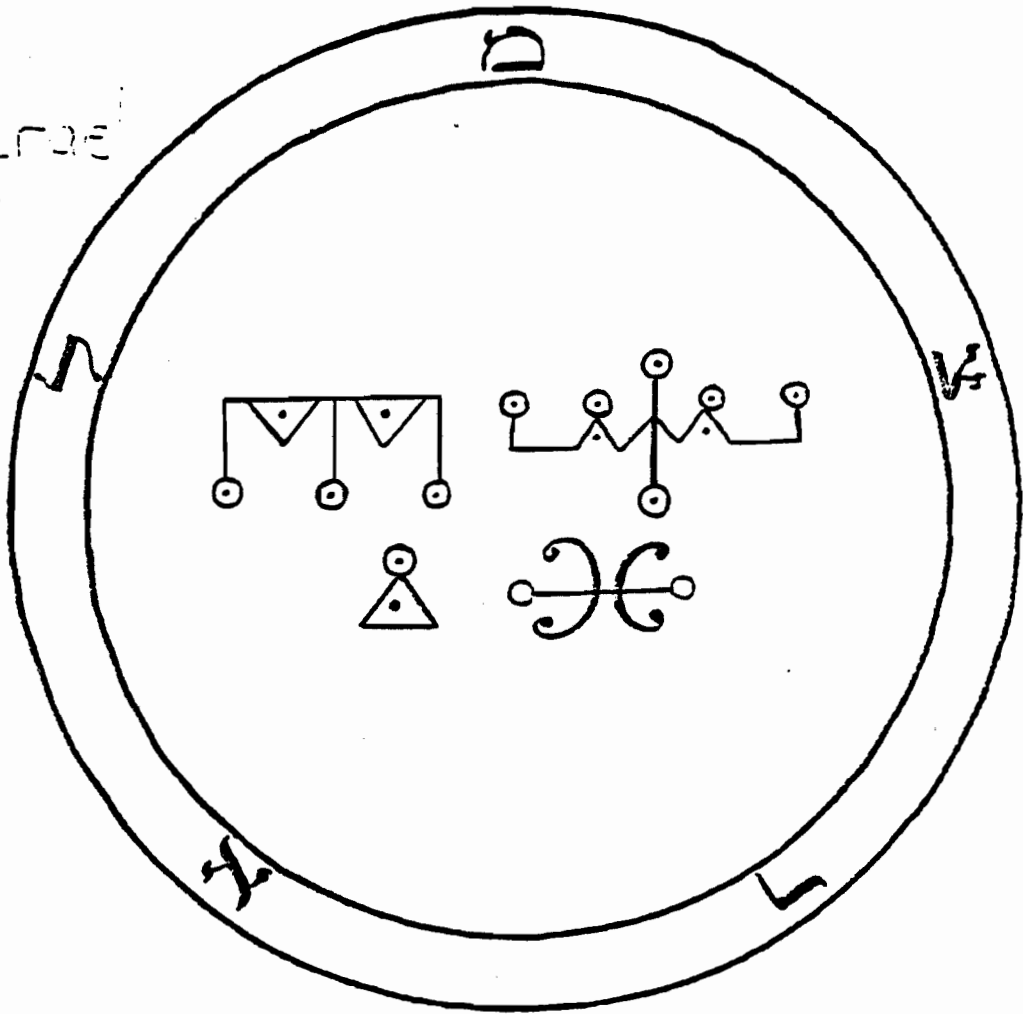

Varnibael

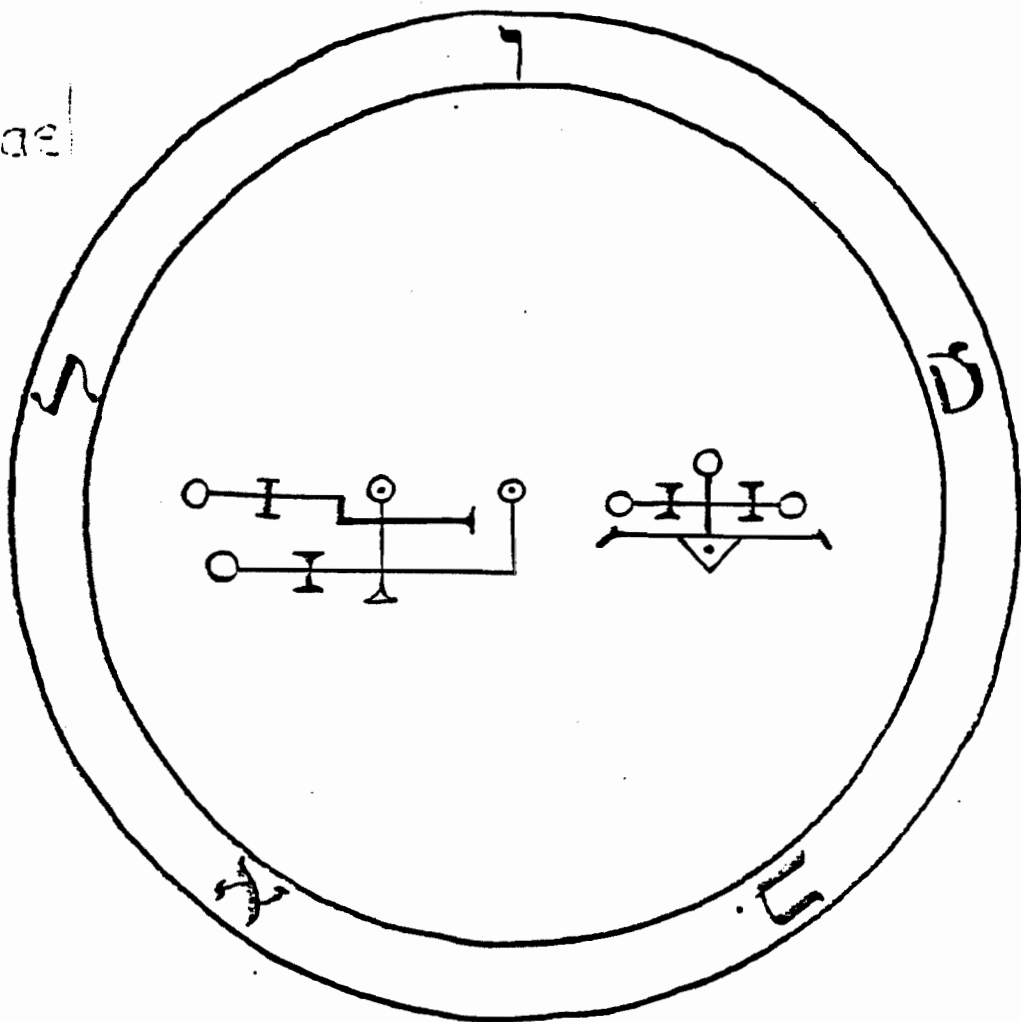

Parade

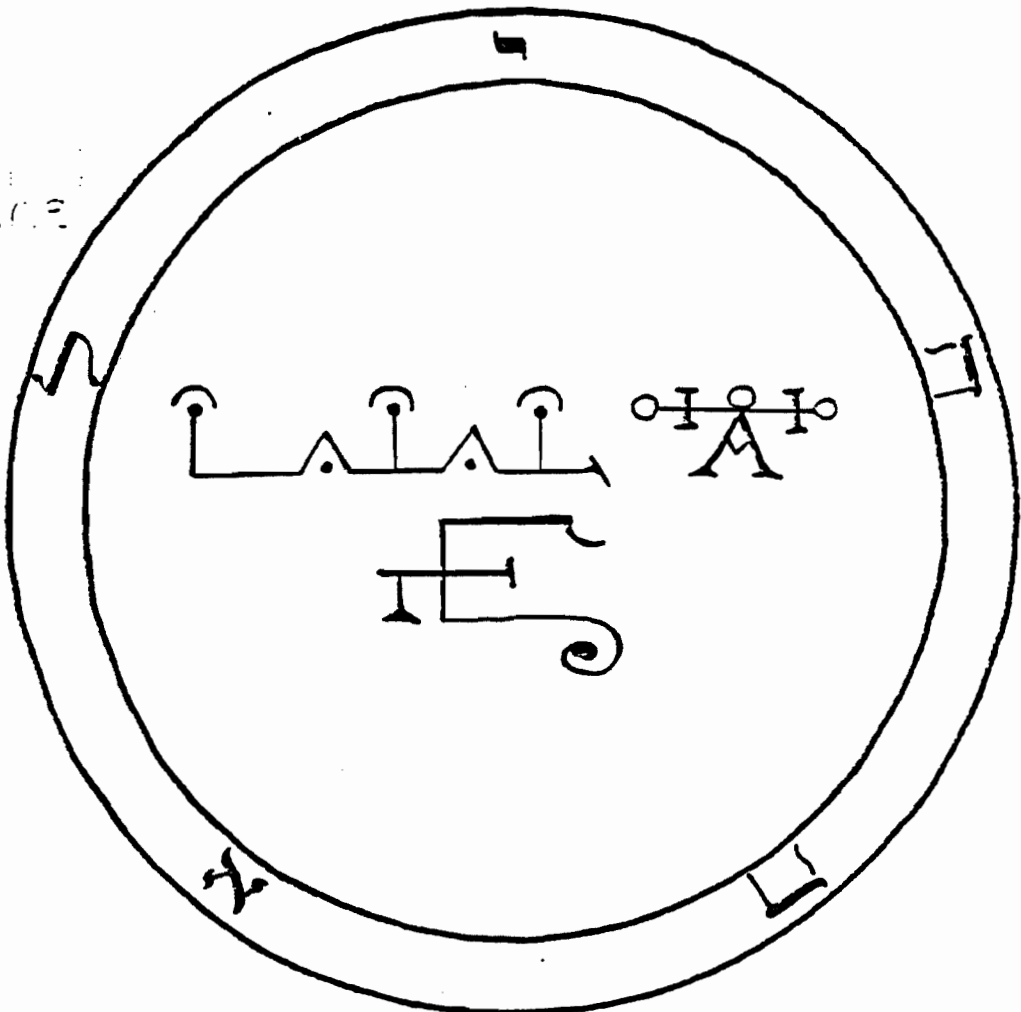

Nghaneauel

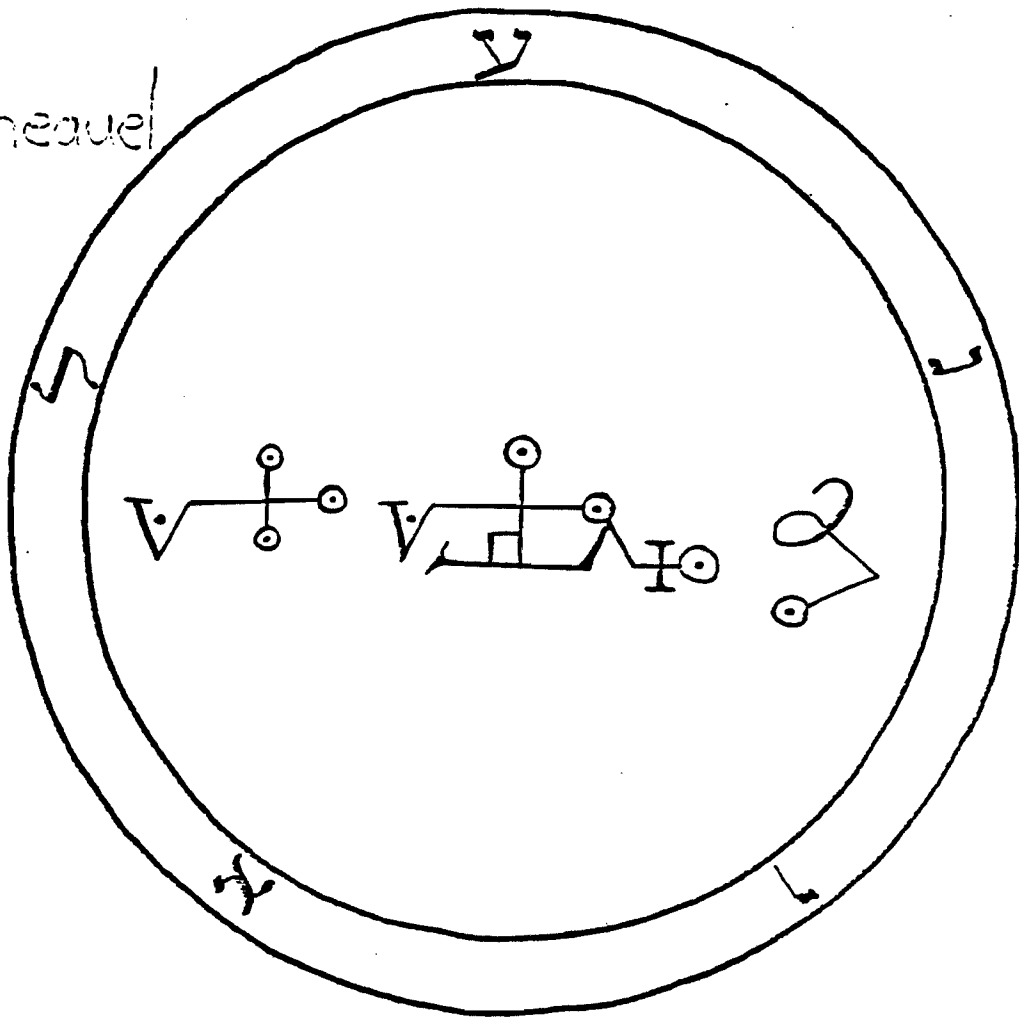

Mochauel

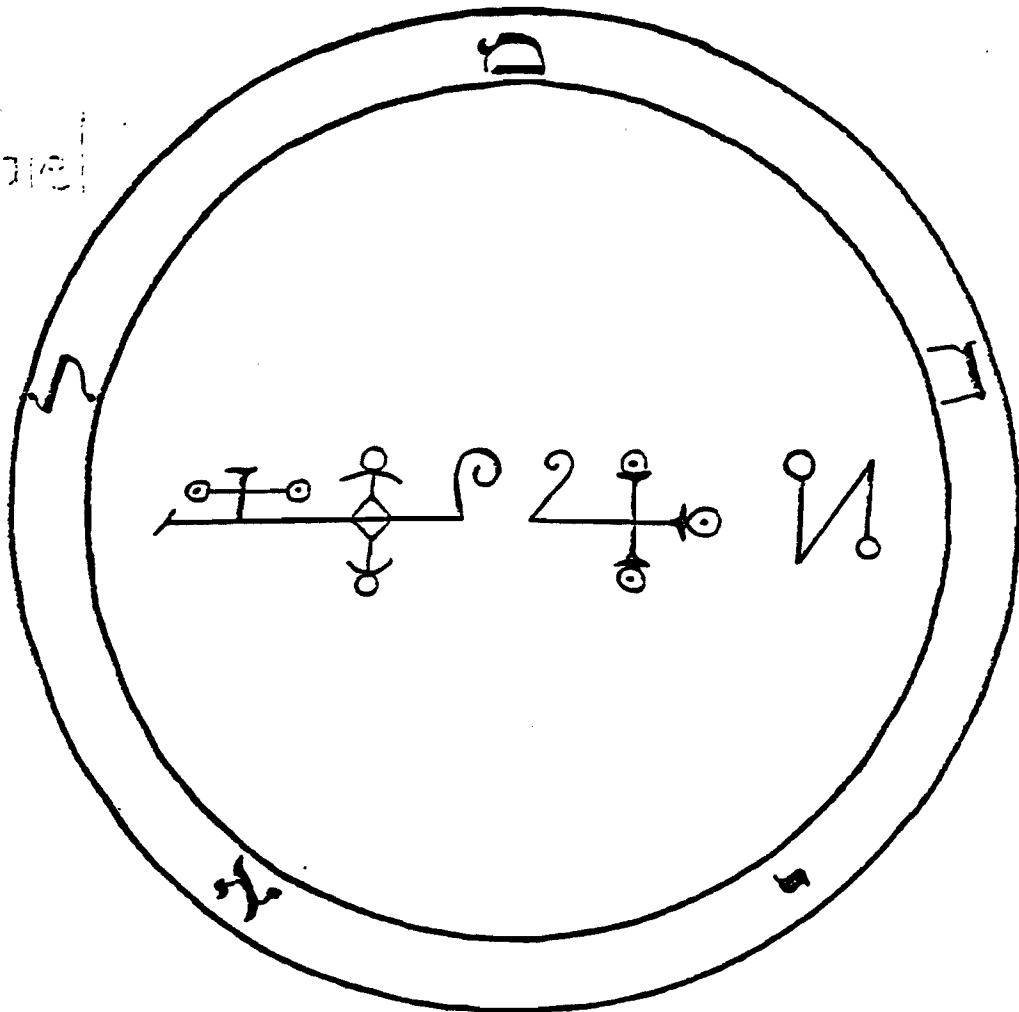

66 Mengel

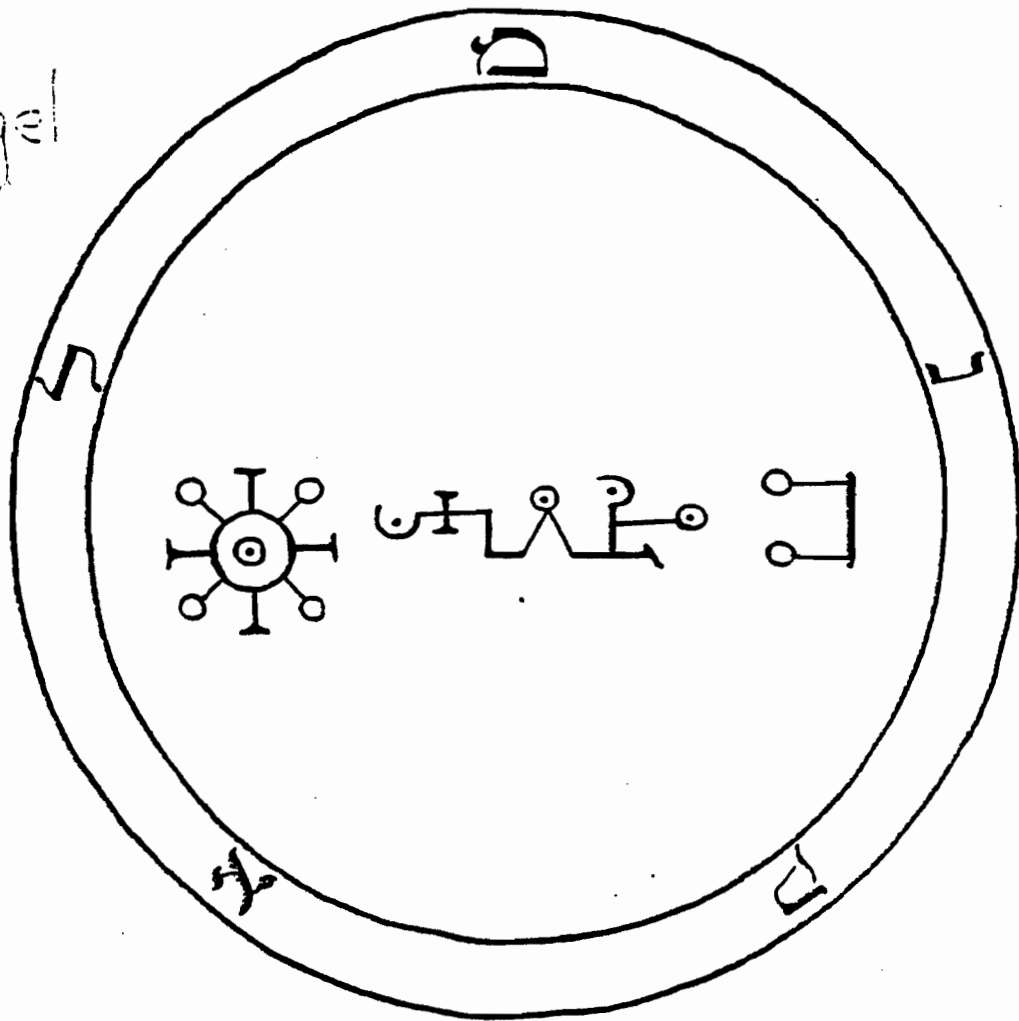

5 Daanabunah

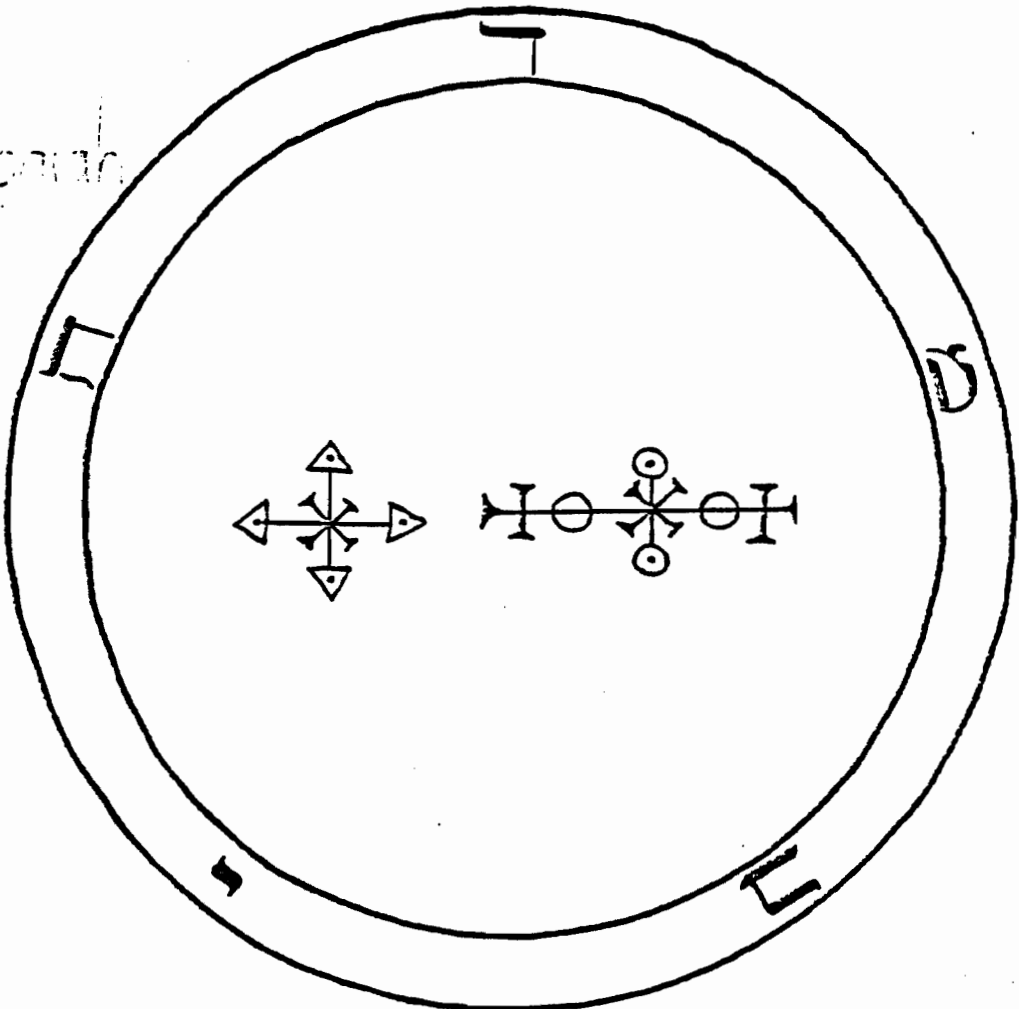

67 Aiael

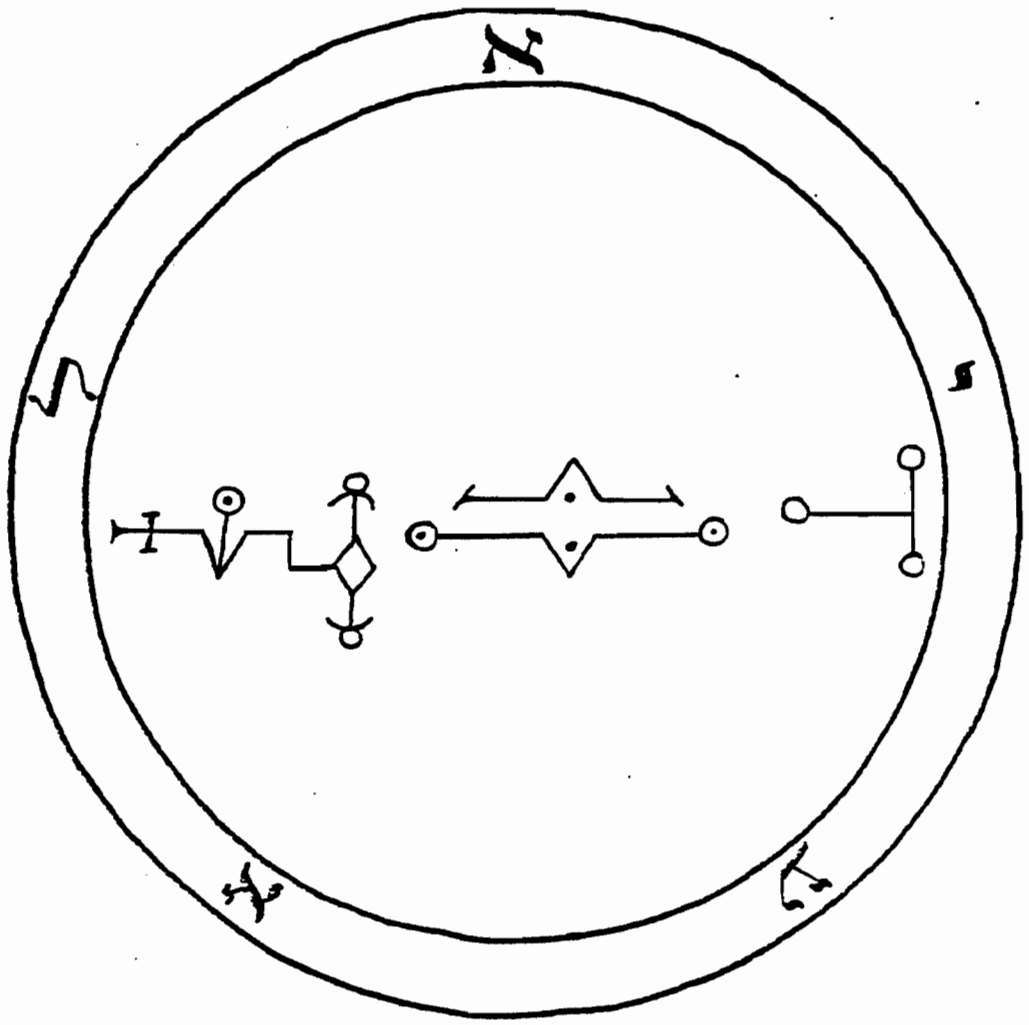

68 Crabentia

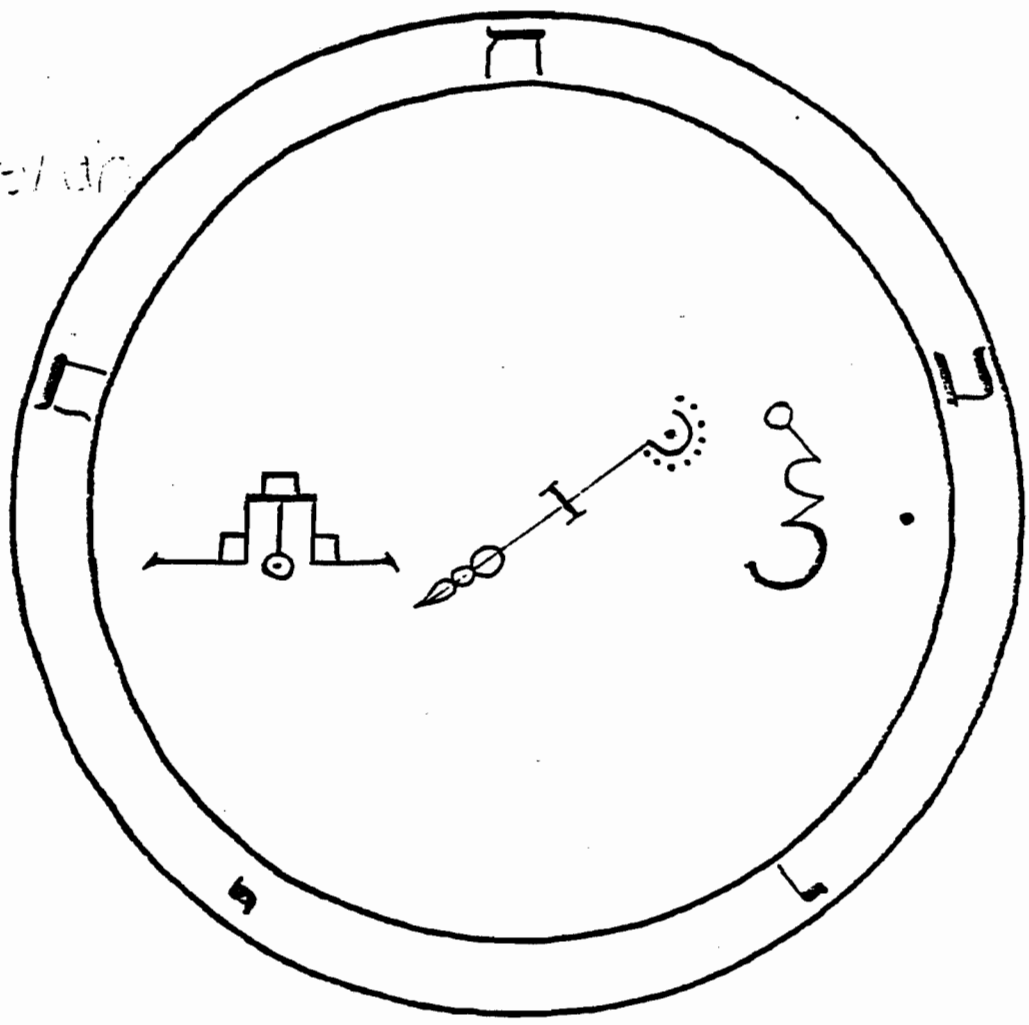

Rohael

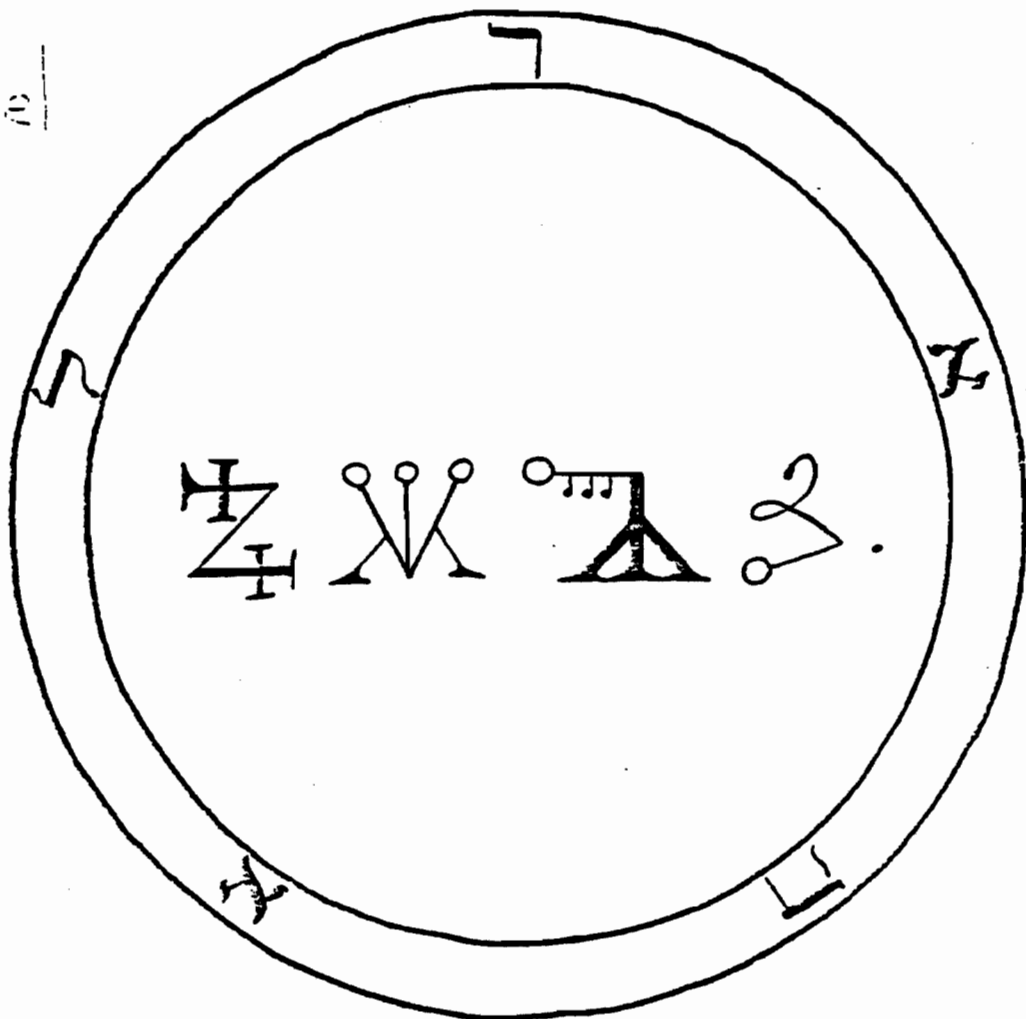

XE-GAMMA

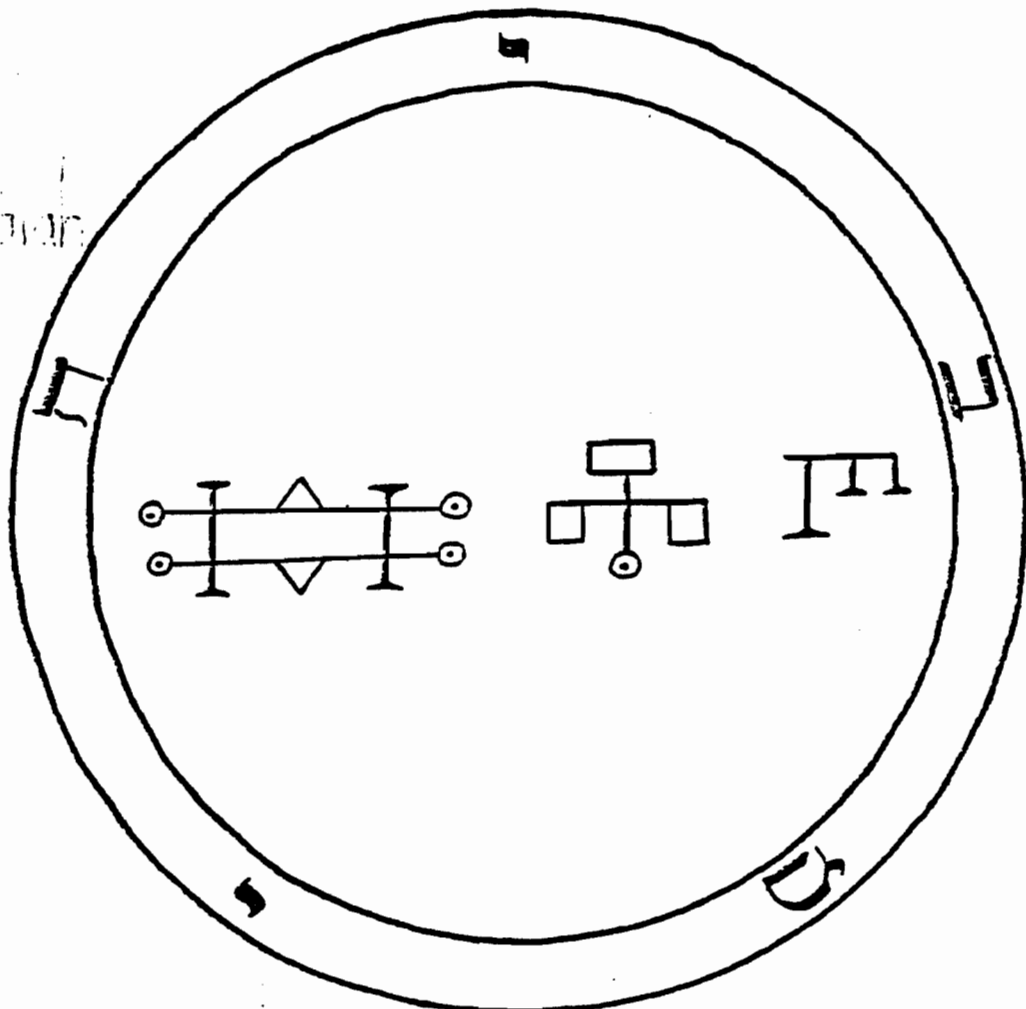

Heyaiel

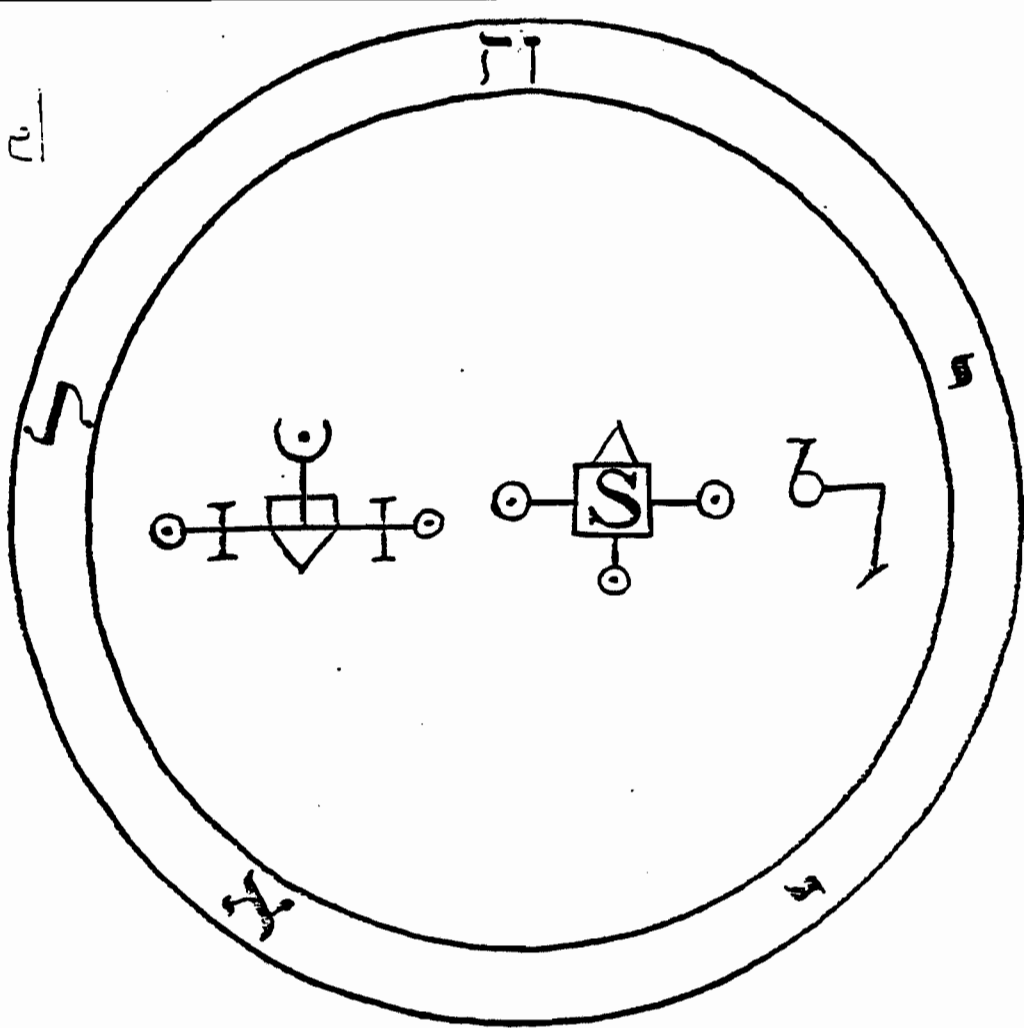

2 Mevannah

