

40p

[9]

# **The Power of The Logos (The Divine Word)**

by  
Basil LE-CROIX  
(Also known as Basil Crouch,  
author of *The Dark Side of  
The Moon: A Complete Course  
of Magic and Witchcraft*).



Copyright 1995  
FINBARR INTERNATIONAL  
F196

# THE POWER OF THE LOGOS

Logo: Son of God (Oxford Dictionary)

Down through the ages a story persists. It is a strange story which tells us that the history and the destiny of mankind is written in the stars. Surely, that means astrology? Yet destiny does not fit in somehow and history, no, that is not quite right either, so we must look for a deeper meaning.

Who came from the Stars? Every race on earth tells legends where a race of super beings came from the stars. The Christian religion says that the children of heaven, the sons of God, descended from the stars. Other religions put it in a different way.

In the East we hear that the Lords of Flame came from Venus and inhabited this planet. In Tibet we are told that the earth is under the guidance of the Logos, a race of super beings from the skies. At other times, in other places, we hear of the shining ones, the great ones, the angels of heaven, the adepts of mystery, the lords of the angels, the space gods. All this is very confusing, but one thing is certain: some beings certainly visited this planet and they were superior to us human mortals. From the monuments they left behind we can tell that they had many powers and used methods unknown to us to the present day. They carried out vast engineering feats which we can not emulate today. They were far in advance of the people of the earth. In fact we cannot even now invent anything new, for these mysterious men have used all the things which we ourselves consider as being invented by us.

Fortunately they have left us many clues which can be used for our benefit. We need only seek in far off and strange places and we will find details on how to become rich and healthy and how to be a prosperous and happy race. Unfortunately for many, the people who have access to this knowledge persist in keeping it to themselves.

In this book I will gather together this information and write it in a simple way, so that all who read this may enjoy the fruits of this knowledge. To this end I present to you the antediluvian Order of the Cube, the 'Four Square Gospel' of the secrets of the Logos.

Let us return for a moment to astrology, not so much to study it but because

it can be helpful to us. It was written over the temple of Apollo at Delphi 'Man, know thyself'. The Logos say, 'Man, know thy enemies'. This is where astrology can help. If you purchase a book on the zodiac signs you will find that, generally speaking, people born under each sign do have very similar characteristics. Should we have enemies, either real or imaginary, and we could find the date of their birth, then we can tell, from the sign under which they were born, in which way we can expect trouble. Being forewarned, we can take steps to nullify the actions.

Enough about astrology. We are seeking much deeper knowledge. Our knowledge will come from far off places and from remote jungles, from ancient manuscripts and from carvings on old rocks and tablets, often in the form of riddles. Hundreds of years of research have unravelled the secrets behind these carvings.

## Words of Power

Have you heard of the words of power? What are they? The Holy Bible says in effect, 'In the beginning was the Word ... And God said let there be light and there was light.' From the dawn of time, in every legend of every race, I have found that the priests use words of power.

Here is a strange thing: no matter where I go, no matter whom I ask, I receive the same answers to my questions about the words of power. It would seem that almost everyone I ask 'Have you heard of the words of power?' replies 'Oh yes I have heard about them.' Then I ask: 'Can you give me one?' Sometimes I am given a Mantra, as used in Yoga, but more often the answer is: 'Well I did know one, but I can't remember it at the moment'.

Then I ask: 'What is this power these words give, how are the words formed, where can I find out about these words, and who used them and why?' Believe it or not, I seldom find the answers to any of these questions. Can you tell me the answers? NO. Never mind, you will know the answers to these questions and when you know them I will ask you to be like the priests and to keep the secret for yourself. I can't make you keep secrets, but I can warn you of what will happen to you if you don't. You will become a superman or a superwoman and as such you will be hated by all. You will be persecuted and shunned, you will be known as a big-head, your friends will desert you and life will become unbearable. That is the lot of all those who rise above the norm, so, for your own sake, keep this knowledge secret.

What will these words do for you? They will make you rich, they will make you happy, and they will make you healthy. All these things are easy when you use the secrets of the Logos, the secret of the 'Four Square World'. They will give you all the wealth you can ever require. What good is wealth to you if you are ill? If you are suffering from any serious illness, can wealth cure you? No, money will not give you health. It can, however, pave the way to the best medical knowledge available.

You must realise that no doctor ever cured any person of any illness. The cure can only come from your own body. Medicine can assist your body to cure itself, magic can help you to achieve the mental condition for curing yourself, but the cure itself must come from within. This is where the words of power come into play, for the power behind the words is a mental power, yet, in its use, no power must be used. Yes, this is a riddle, but the answer has been found for you. All you need do is follow the instructions.

I am always asked what the words have done for others. Listen to Sally:

I was done for, dead beat, and with my last penny I went into this caff, got a cuppa, couldn't afford no food. I sat there, and true I thought perhaps it would be better if I jumped in the river. Oh, I was low. I had been off work for months, left home to try and get a job in the city, fool that I was. It's hopeless ain't it?

Well I'm sitting there when in comes some boys wiv gitars, been playing down the road till a copper moved them on, I'd seen them before I come in the caff. Well one of them comes over to me, 'Want a cuppa?' he asks. I know he wants more than that from me, but I'm skint so I say, 'All right but no funny business, I can't stand it.' So another comes over saying 'Leave the kid alone.'

He sat down, this other boy and put on the table a funny looking object, sort of tapered it were, and had a square box on top, I put out my hand to touch it but he grabbed it, 'Don't you ever touch that' he growled, 'You keep your flipping fingers away from it, see'. Well I don't know what was up with him but he sure looked at the flaming thing as if it were God or something.

Another lad came over saying 'What's up, sis', I started to cry, and this boy says, 'Dry up kid its not that bad.' But I cried. I couldn't help it. Then this lad bought me a coffee

and a sandwich and when I wolfed it down he got me another, then he said, smiling at me, 'This gadget is our lucky charm. All the time we have it we will make money. Got it off a priest of some sort. If you want money kid, just touch it on this side and pray for some cash, but do it real serious, or not at all.'

Well, I touched this box on top, it had some squiggles on it that I had to touch and he, the boy, wrote something on a paper. He told me to sort of hum this word, damn silly I felt doing it, but he was so sure it would help me, so I done it. Then while I was a humming like, he put this paper what he had written on in the box. Well, that's all.

Where did I hear this story? I was speaking to this lady, in a guest house at a certain sea-side town. The lady in question was the owner of the house and was the girl in the story. I asked her how it came about that from a down and out girl she became the owner of the house by the sea. She said:

After the boys had left, I sat there for a while. It was raining, so I was in no hurry to move. Then it cleared up a little outside and I rose to leave.

I had just got outside when an old fellow slipped and fell down. I helped him up and we went back in the cafe. He was alone in the world and he offered me a home here in this house, helping him. He was a lovely old chap, he was. About a year later he passed away. I was with him to the end. In his will he left everything to me, this house and nearly five thousand quid in the bank!

'Is there anything in this world that you would like,' I asked.

'Yes' she said, 'I would love to have that box. If I could only have that, then I could own the world'.

That is how it all happened, just by touching that box and humming a word she came into a fortune. Yet, this is not strange, it happens all the time. It never fails if it is approached in the correct frame of mind. What could be more simple? Touch, hum, and the world is yours for the asking. You want one of those boxes? You shall have one in good time.

Who is that man over there shouting the odds? I will call him Wally G. He is a very rich owner of a string of race horses. 'Hey Wally' I call, 'You



have promised to tell me a story, remember?' 'Yes,' says Wally, 'I remember'. Here is the story of Wally the race horse owner:

It is seven years ago now. I had just left the army, spent all my cash on the girls and had a fine old time for a while. Then the cash ran out and I was broke. I could not raise a penny from anywhere. I went down to the docks, thinking I might pick up a pound or two, be able to carry a bit of luggage around, even be able to steal a suit case. You know how it is; if you get hungry enough you will steal anything. I do feel ashamed about it now. Still, as luck would have it, I didn't steal anything, but I might have done if things had turned out the other way. Well, a chap I knew in the army comes off the ship, home on leave. 'Hey,' I shout, remember me?' 'Well, if it isn't old Wally, how are you fellow?' he asks. We get talking about old times and he asks me to come home with him. He lives not far from the docks, so I help with his cases. 'Don't mind my old Mother' he says, 'She's a bit of an old witch, got all sorts of queer things around the house, ninety-six she is and still going strong.' We sat around that evening drinking beer and the old girl asked me to stay and keep them company whilst my mate is on leave, so I stayed. She had this fancy box in her lounge, and I looked at it, wondering what the heck it was. She said, 'If you want of anything in this world, all you have to do is pray for it while touching this funny looking word which is on the side of the box at the top.'

After they had all gone to bed I came down and touched that box and prayed for some money. Then I sneaked back to bed and forgot all about it. A couple of days later I was in the Pub having a drink. I picked up a draw ticket for the Irish Derby and asked around if anyone had lost one. Nobody claimed it so I put it in my pocket. That ticket turned out to be for a near favourite in the race, so I thought that I was on a good thing. At the back of my mind something was telling me to sell that ticket, so I advertised and asked for offers. I was offered five thousand pounds for a half share, then another bloke offers me the same amount for the other half, so I sold it.

What is this strange power that comes from this box? How is it controlled? Does it really matter how or why it should work in this strange manner? You will be satisfied to know that it does work. We can leave the how and the why to the curious. It is enough to know that it will give us health and riches and that with the help it gives we can live a long and happy life. I am approaching my eighties, but I am well, live a full life and am free from worries. If it does this for me then it will do it for you. It is a secret left on Earth by the Logos:

I have mentioned the 'Four Square Gospel'. Have you ever noticed that we live in a four square world? Four square? The popular conception is that we reside in a three-dimensional world, but that is not quite right, for we must take account of time. We exist also in time, so it would be better to say that we live in a four-dimensional world.

The figure four abounds in our lives: four weeks in a month, four points of the compass, four seasons, the four Elements (fire, water, earth and air) and in our religion the four Gospels, the four Archangels, etc. To the student of the Occult, four represents the most primitive number.

We must also remember the four arms of the cross, and why we use a cross to represent a kiss. It can be said that the number four rules the world. Why are altars mainly square?

'And I saw a new heaven and new earth; for the first heaven and the first earth were passed away; and there was no more sea.'

And he that talked with me had a golden reed to measure the City, and the gates thereof and the wall thereof. And the City lithe four-square, and the length is as large as the Breath...

From the Book of Revelations

Jerusalem is known as the Cubic City. It was stated that the centre of the Temple contained a large natural stone which was square in shape. Learn the power of the cube and you can tap unknown sources of wealth and riches.

A few words here about the pyramids. We shall be using pyramid shapes to gain all that we are seeking. It is generally understood that the pyramids were built by the Egyptians. There is ample evidence for those who seek it, that they had the technical knowledge to build them. Surprising as it may seem to you, the Egyptians had the knowledge of the powers of anti-gravity.



There are written records of large space ships operating in Egypt. In the museum in Ethiopia is a manuscript written by Enoch in which the stealing of the Ark of the Covenant is described. It tells how the Son of Solomon took the Ark back to Ethiopia, to his mother the Queen of Sheba. It is of no interest to us except that it shows that the Egyptians had the knowledge and the power to build the great pyramid.

That manuscript is not the only source of the story of the stealing of the Ark of the Covenant; the Egyptians have recorded it in hieroglyphs for all to see. To him who seeks shall be given.

I know that you are eager to start making your very own pyramid. It is not exactly a pyramid, rather a pyramidal charm. A charm that must surely be the most powerful charm in the world. Yet I think it is more important that you should know a few things about the pyramids before constructing your own.

The great pyramid of Gizeh had a chamber at a certain height. In this chamber was an altar; perhaps we better call it a table of rock. From all the existing records we know that the Pharaohs were the richest and most powerful of all the known kings. The secret of their power lay in that central chamber.

The kings and the priest would formulate the desires of the people and the methods needed to bring about a prosperous time. These plans were written on papyrus and then laid on the table in the chamber. Prayers were said and then the plans were left for an agreed time. After receiving the powers that had been requested, further plans were drawn up and the procedure was repeated.

I admit that is a very skimpy revelation, but we are in a hurry and it does give a brief outline of what we must do later on. Another thing must be remembered: the outside of the pyramid at one time was smooth, and carved into the surface were certain hieroglyphs. We will look at these later on. Suppose that a man suffered from an illness. He would go and lay on the pyramid on the sign for the relief of his complaint and in a few days he would be cured.

A man or priest needing wealth would lay on the side of the pyramid that would give wealth, knowing that in full time that wealth would be given them. Suppose a man needed water for his plantation - the land of Egypt was a fertile land in those days - he would lay on the side that represented water, and in due course it would rain. I tell you these things because you will find when you have your model, that if you build pyramid shapes you will invoke strange powers.

Whether you believe this or not, it is true. It has been proved over and over

again by many people. At the present time many people are experimenting with pyramids, which is why I write this book. Their power has been named VRIL. What is it? Nobody knows, but then, nobody knows what electricity is, yet electricity is very powerful.

The strangest thing about the pyramids is that they are not perfect. The pyramids of Egypt are merely copies of much older pyramids, and they are not true copies. It would appear that the true knowledge had been lost at the time the pyramids were built, but from old manuscripts we now know the truth about them, and this truth is what makes our models so powerful. It has been said that the angels before leaving this earth left behind them a blueprint of man and his destiny. Some say this is the blueprint, some say that something else is the blueprint and the argument goes on and on. Some say the answer is in the Cabala, some say it is in the Bible, some swear by the Zohar, while yet others say it is to be found in the Writings of Enoch.

Deep in the Rain Forests of Brazil are to be found the remains of pyramids thousands of years older than the pyramids of Egypt. From a manuscript found in the archives of some secret societies we can obtain knowledge of the original shapes of these pyramids, and we can see where the pyramids of Egypt differ from these monuments left behind by that race of super beings.

Also to be found in old manuscripts are the remains of a secret language used by these same beings. Years of research by learned occultists have deciphered much of this language. Experiment with many of the symbols left on Earth have been proven to be effective. We will be using some of these symbols and you will find that you have the key to words of power. These words of power are only of use to each individual; my words, very powerful words indeed to me, would be completely useless to others. Each person must use his own words.

In the year 1404 Frenchmen landed in the Canary Archipelago. They found a tall fair-haired people who said they were the last survivors of a great flood which destroyed the world. They were a friendly people who had powerful magic working for them. In time these people were massacred by the Europeans, but before that time they were visited by the Spaniards who found them brave and incorruptible.

These people left behind data on the use of small pyramids and the symbols to be used with them for obtaining wealth and happiness. They left records showing that, if one makes a small pyramid, in, and around that shape, strange powers are called into existence. No-one has ever discovered where these powers originate, or where they go, but we do

know that the universe is controlled by strange powers.

The earth and the other planets which form our solar system are kept in their path around the Sun by some strange force. We know that all life on this planet is controlled by powers which move in cycles. The moon exerts powers which control the seas, other planets may control other seas, other suns may control other worlds by this same power. It comes from space; what it is we do not know.

We do know, however, how this power can be controlled and brought into use for our benefit. We know it can make us rich, we know it can be used to help us gain perfect health. It can, and will, work for all.

Penelope came from a large family. At the age of 14 she ran away from home. She went from town to town seeking work, had a few jobs here and there, but things got steadily worse for her. She took to sleeping rough in the parks during the summer months, but when winter came she slept in empty run-down houses. As you might expect, Penelope got herself into trouble; she became very ill and lost her baby.

She was taken to hospital after giving birth, on her own, in a house; her screams alerted the police who took her to the hospital. After being discharged she wandered the streets and got caught up in a gang of boys who were raiding shops and buildings. After a short time they were arrested and brought up for trial. Penelope was sent to a house of correction, but owing to her previous way of life she fell ill, had an internal infection and was given up as incurable.

Wandering around the town, miserable and lonely, waiting for the end, not really caring about the fact that she was slowly sinking away, she went to escape the falling rain into the local museum. Then a very strange thing occurred: an assistant knocked over a case and that case contained a model of a pyramid.

The assistant stood, white faced, looking at the model on the floor. Penelope went to help but the assistant said, 'Please do not touch that pyramid. I have been told that a curse has been put upon it. Whoever touches it will die'. Penelope said, 'Well if that is the case I will pick it up and put it back in the case for you. I'm going to die, so it doesn't matter much about the curse, does it?'

She picked it up and replaced it, but as she put the small box on top of the pyramid she felt a shock like a lightning bolt pass through her. Quickly she made her way to the toilet and was violently sick. After recovering her breath and rinsing out her mouth with water, she had a feeling coming over her which, she said, felt like a hot wave passing through her body, and the strangest thing was that she felt really happy.

So happy was she that she burst out laughing. Then, looking around, she wondered if she was losing her mind but decided that she was still sane. On leaving the toilet she discovered that the rain had stopped so she left the museum. She had only walked a few steps when she saw a purse lying on the ground.

Picking it up she found it was full of notes, and being hungry she took just one note, then handed it in to the police. There a woman P.C. said, 'That is very honest of you,' and gave Penelope a one pound note to buy some food with. After three months no one had claimed the money and it was given to Penelope. She invested it in a partnership in a cafe. Many years later she's a rich woman, thanks to that pyramid.

I have described three cases, cases of people who only touched a pyramid. Do I hear you saying, 'just another book telling what other people have done?'. Yes, it is a book telling of the success of others. But make no mistake, there is no better way of learning than by the study of what others have done.

When a man wins the football pools, people immediately ask how he did it. A man finds a way to make easy money, and what do others ask of him? How did you find out how to do it? A man finds a fast selling line, and promptly he is asked how he found out about those goods. If no-one will reveal how things are done, then who will benefit?

A woman is dying of cancer; all hope is gone, there is no reprieve, then suddenly she is cured. Immediately she is asked to write about her experience and about the way she found the cure. How are you to learn unless you read the way others have found all they seek? I can tell you do this, do that, or do the other, then you may do these things, and if you do you will be gaining. But how much easier if I tell you how others have done it, so that you can follow the procedure the others before you used.

Many, many years ago, I was a lad working on the land, my wages a mere twelve shillings a week, plus my food. A mere pittance. To make ends meet a pal of mine suggested that we took to poaching at night. And so I became a poacher. Soon we were caught. The land on which I was caught belonged to an elderly ex-captain of the army.

Instead of taking us before the local magistrate he gave us a chance to apologise. I went to see this man and was ushered into his den. I stood with my mouth open: never before had I seen a room like that. On the walls were trophies from all over the world. I gazed upon them in wonder. He ranted on at me, telling me I was no good, this, that, and the other. Even now I don't remember half of what he said.

But, standing there, I looked at that room and there and then I decided that

one day I would have a room like that. Well, time has changed those ideas, I never had a room like that one. As I grew older other more important things have taken over, but one thing never changed: my desire for wealth. As I stood in that room one thing happened to me. In some way I managed to isolate the idea that in time I would be rich. I may not be rich but I am well off. I have been the owner of flats, houses, fast cars. Now I am content to sit and write. My wish now is to tell others how to gain what they desire.

One thing becomes increasingly obvious: all magic or all desires are granted through the operation of mind. It could be that the power of the pyramids in some way affects the working of the mind. At the present time no one knows how it works or what this strange power is. We only know what it can do and some day somewhere, somehow, someone will find just what this power is and how to invoke it.

It could be me, it could be you. It certainly will be some person who makes a model of a pyramid and avails himself of the rituals of the long forgotten race that built the pyramids.

Now the time has now come for you to build your own model. Just follow the patterns given and you should have little difficulty with the construction. First make a template as in fig. B, and use it to fashion fig. C. Then glue B to the flaps of C. Fig. E should be folded and glued to fit the top of the pyramid like a cap, then F is folded around to form a lidless box. The pyramids in the jungles of the rain forests have flat tops, and on those tops the ancient priests had temples built. In the centre of the temples they formed their altars. It is there, at the top of the pyramid, that the strange powers exist, and we will use these powers to obtain what we desire. Anything we wish can be granted by this pyramid, or charm, which you are going to construct.

As a passing thought I will reveal part of the legend behind the religion of this ancient race. The original pyramids were built for the purpose of preserving the dead bodies of the kings and high priests of that race of super beings. They knew in their wisdom that some day in the future we, the race of earthly humans, would have the knowledge to bring back life to the dead.

We must realise that on the death of a person the disease or whatever was the cause of death would be wiped clean. No disease can exist in a dead body for more than a few days or weeks, so if the dead body can be preserved for thousands of years then if it can be brought back to life. It would be perfect.

We have been told that the pharaohs built the pyramids as tombs for the

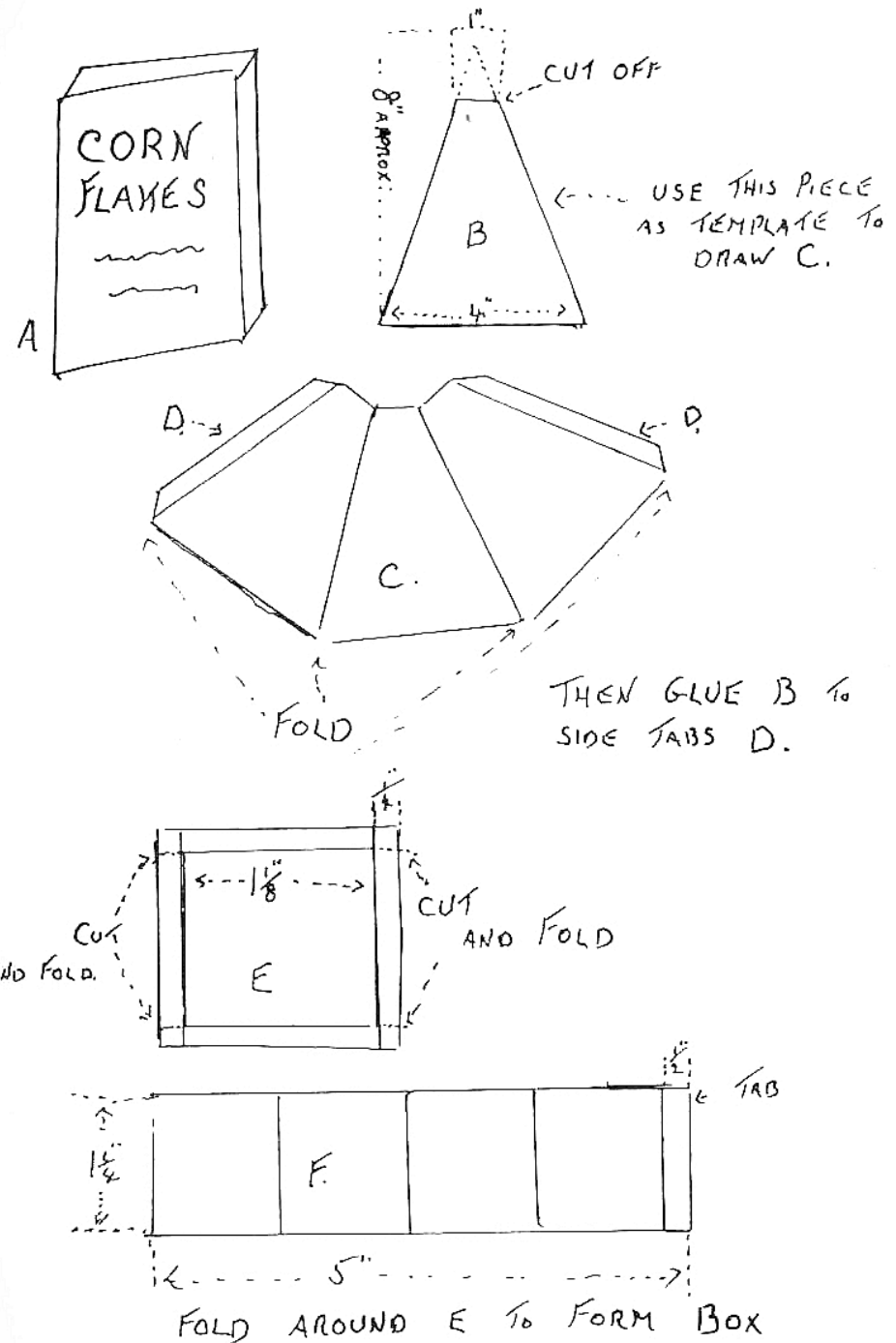



kings and priests, who were laid in them with all their wealth. That is wrong, they did not build them, they discovered them after residing in Egypt for ten thousand years, and having discovered them we are told that they used them a tombs. Yet nobody has ever found a body in the pyramids.

The truth is that the pyramids were plundered long before the Egyptians found them, after a severe storm which uncovered them from the sand. The fact remains that the pyramids have been found thousands of years too soon. The race which found and robbed them in the distant past knew nothing of the race of beings from the starry heavens, and even much less about the religion and super-power of that race. The bible refers to them as the Children of Heaven, the race that spoke and used a language that is unknown on Earth. The only humans we know of, who used to speak with these angels, are the prophets of the Old Testament.

We, the know-alls of today, admit that we do not have the knowledge to build the pyramids. We suppose they were built by slaves pulling these huge blocks across the deserts and lifting them up to form the superstructure of the great pyramid.

If only these people who know so much would study the ancient manuscripts and carvings left behind by races of untold antiquity, then they would become aware of a race of beings who could in some way invoke a power of anti-gravity. Also, they had a way of making granite or other forms of rock malleable like putty. With these two powers it becomes almost like child's play to build these super structures.

However, all this is of no interest to us except as thought for meditation, so let us get back to our model. The pyramids in the jungle are covered with grass and creepers, so, to be realistic, we must cover our model with green paper. If you can find in a toy shop some flowered paper used as wall paper for a child's dolls house, then by all means use it. Failing that use green paper. The open box at the top should be left white. And now some real trouble: go out and collect 9 pebbles of a size that will fit into the open box. I know, it's a bother but the more bother it causes you, the more benefit you will receive from your charm.

The four sides of the model will represent the four compass points and each side has its own spiritual beings and its own hieroglyph. Draw on the east side the illustrated symbol. This is a very ancient symbol which represents Air. The east side of your pyramid is identified with love and peace of mind. Whether you realise it or not, you need love and peace before you can enjoy life to the full. By saying love



I am not necessarily implying sex. Most people need contact with other people, but you do not wish to jump into bed with everyone you meet. Even if you are almost a hermit, you still need love, and first and foremost you need to love yourself. Never forget that the way you see yourself is the way others may see you. Do you like the way you are? Are you contented? If not, if you don't like the way you are, the odds are that you are out of line with destiny, and if that is the case then other people are getting the luck which is passing you by. The love of well being, the love of peace in your own mind, this is the power the East side can bring you. Grasp it in both hands. I know you are seeking a way to gain wealth, but first gain peace. Wealth without peace is of no good to you. Tune in to the East and gain peace.

Before I describe the Ritual of the East Face I would like to tell you about Berty C. He worked in a small garage. His wages were low but he survived, lived in a small bed-sit in the town, went out during the evening, sometimes to a disco. The one thing he really wanted was a girl to share his life with. This is Berty's story in his own words:

Yes, sure I wanted a girl, other blokes have a girl friend but somehow I could never get far with them. I used to buy the girlie Mags, you know the sort with nude pin-ups in, I would lay in bed and read the books wishing I could get a gal like the bunny girls in the book, but never had no luck.

Well I never had much to offer 'em, and as for looks, well I'm not ugly but again I ain't no fancy mug to look at. I never found enough cash to run a smart car, would like to, because a smart car helps but as I said I could never afford the payments, on my money. Another thing, I am a bit shy when it comes to chatting up girls. Then this day, a geezer brings in a car what's acting up, and on the back seat was this book on pyramids.

I knew the owner would not be coming in for a day or two, so I took the book home to read, I had glanced through it and well it appealed to me. So home I went and started to read. The stuff on the East Face about love etc., well it fascinated me I can tell you. Well just as a lark I dreamed up a perfect dolly of a girl that I would like to have around me.

Just to think about it like, a perfect girl, a real stunner, a girl that would obey my every wish, a girl that could satisfy my every longing, just to lay there and dream, oh boy what

wouldn't I give for a girl like that, and then in the middle of the night, I was sound asleep when something went CLICK, and I leapt out of bed wondering what the heck had happened, and then a thought came to me from nowhere, MAKE A PYRAMID.

Oh yes, I made it, just had to it seemed, and then I tried the East Face Ritual. Did it work? I say it did. It was amazing really, it took less than a month, still can't believe it. What happened you ask? Well a pal came in one day saying, 'Look old chum, my sister she has a little coupe you know, got a bit of trouble with it, can't afford to take it in for a repair, think you could help her out a bit cheap like?' I said yeah can do, and she brought it in after the boss had gone home, well I don't know just what happened but something between us went Spang, and in less than a month we married.

I now have everything I dreamed of, our love is perfect, my wife is a splendid cook, she dresses well, she is my ideal of what a wife should be, she loves me, will do anything in the world for me. She is a perfect companion to me, and at nights, well, better perhaps if I leave that unsaid. And of now; well I have a smart car, and what's more I have the girl to go with it. That East side power sure has made my life.

I have said that we can learn from the study of what others have achieved, so let us look at this story of Bert. First he dreamed of what he desired; in his own words he dreamed up a dolly of a girl. Then after the dreaming period he fashioned a pyramid. Next he practised the simple ritual. The next part he does not state in his story, yet I think that part could be the most important part of the secret. After the Ritual he continued to live in the normal way, went to work and FORGOT all about the ritual.

So now we have it: Dream your dreams, use your pyramid ritual and forget all about it. Just sit back and wait for the power.

Now look at drawing A. If you put the symbol I have described near the top of the pyramid then the next two can be placed as shown. Draw the palm trees underneath and then the symbols. The symbols are:

- at the top, the ancient symbol for air, it is pronounced UN. The circle stands for air and this should be drawn in blue - use a felt pen for these drawings. It is known as the circle of Vayu. Level with this symbol draw the bird shape. It represents the letter A in Egyptian language, and it is the

first letter of air, and without air we cannot live.

- at the bottom write the name of the archangel Raphael. Last of all, on one side of the little box at the top of pyramid, draw the symbols which stand for the guardian angel Shinanim. These symbols and names are taken from very old manuscripts to be found in a museum in Ethiopia. They are inscribed on copper sheets, or rather a metal similar to copper.



Having drawn all your symbols, place the small open-ended box on your pyramid and take one of your pebbles. If you are having difficulty finding suitable pebbles then take pieces of paper which must be four inches square. Draw on them, in black, an egg shaped oval. In this oval draw in pale green the following symbols.



Should you be using a pebble then inscribe on one side the illustrated symbol. This symbol is the first initial of the Egyptian Goddess Nephthys. On the opposite side, draw in black, an egg-shaped oval. The black oval has always been regarded as the fifth element ether, the gateway between the spiritual and material worlds. You may wish to know why I advocate the use of pebbles. The reason is that the pebbles are a pure source of the earth, whereas paper, although a material of the earth, cannot be guaranteed to be pure. The choice remains with you, both have their sponsors. If you are using paper then, after drawing the symbols which actually are the letters spelling Nephthys, screw up the paper into a small ball and place it in the small box.

Having prepared the pyramid, sit at a table and face the East side of your pyramid. In front of you place a small piece of white paper and inscribe

on it in blue a circle as large as the paper will allow. Close your eyes for two minutes to let your mind relax, then quietly say this prayer.

'Oh thou Raphael, Logos of ancient days, be thou a guardian this day between me and the realm of spirit. Gentle Nephthys, grant to me tranquillity and peace of mind. Reveal to me this day what is right for me to know, steer me gently into paths of emotional stability.'

Now let your mind dwell on some experience in the past where you were at peace, dwell on this for a few minutes, then try to condense that mental picture into one word. Add to this word the letters E.L. and cross out any recurring letter. To make all this very clear let us once more take a case and see how Joe worked out his problem.

Joe had a small business. For a time he was doing quite well, then came a slump. Trade dropped right off. Joe was a worrying sort of man; the more trade slumped the more Joe worried. He should have been thinking about how to reverse this trend of affairs but he could not think clearly because of the worry. In time Joe got so low that he became really ill. His Doctor told him to stop worrying. For Joe this was impossible and he had nearly reached the end of his tether when he came to me and I told him of the Power of the East side of a pyramid. Joe listened, saying 'I have nothing to lose, so I will try it'. This then, is how Joe set about it. He built a pyramid as instructed, he used paper in the small box, for he had no time to spare hunting for pebbles, he drew the Blue circle of Vayu, and sat a while to clear his mind. Then he thought of his youth when he would go fishing in a river near his home. He decided to use the word river as his word of power. This is the how he set about it:

First he wrote on a spare piece of paper: R I V E R. Then he added E.L. This gave him RIVEREL. He crossed out the recurring letter R, this gave him the word, RIVEEL. That word has now become a word of power, for each time Joe casts his eyes on that word he is transported mentally to the peaceful banks of a river.

The story is not quite complete. Joe folded up that piece of paper, placed it in his wallet and never lets it out of his possession. Where Joe goes, there goes his word of power. He is a prosperous man these days, but later on, after gaining perfect peace of mind, he did use the pyramid to gain wealth. Let us at this point clear up a few things. Why use the letters E and L when forming a word? The ancient sages and old time magicians always told their students to use those two letters when forming words of power or

making Talismans. But why those two? Let us refer to that ancient language that can be found on very old manuscripts. We will find that the Letter L means the First. E L means I made you in the first power. Just for the sake of curiosity let us look at the word angel. The first letter A was written On, or Un; this will give us the first part if we say An. The second letter, G, stands for With. Now add the letter E and we get, With our Lord and Master. So now we have, Ang, meaning, On with our Lord and Master. Now if we add the final letters E L, then Angel becomes: On with our Lord and Master, I made you the first in Power.

One other thing to clear up is the use of the Egyptian deities. The Egyptian era is the latest one from which we can gain much information. We know that they took their religion and magic from a much older people. It has been said that they learned their religion from the priests of Atlantis. One thing is sure, the knowledge came from another race of beings, and the only people on Earth who did have knowledge of this race were the old prophets. All that concerns us is the magic they left for our benefit. For those who would prefer to use the planetary signs I will give them as they relate to the gods of Egypt. The goddess Nephthys relates to the planet Neptune.

For those who follow the planets and the Zodiac, the powers and inclinations of those signs can be used. Instead of using the Egyptian gods on your papers, use the planets in place of the symbols, but I can not guarantee that the powers will work the same as when using the Egyptian Pantheon.

Now back to Joe. He could have used the word fishing in making his word of power. As an example we will use this word. We can write it FISHINGEL. Now the recurring letter in this case is I. We now have the letters F I S H N G E L. Let us transpose those letters. Shingfel or, perhaps, Fleshing. He may have seen a lovely girl, also fishing, and he could have used a word to remind him of that girl. I want to convey to you that you can use almost anything to build up a word of power, as long as that word is taken from a period that gave you peace.

Thomas G. Walkner had been a naughty man. He had set fire to a farmer's hayrick, causing a lot of damage. He did so because he had quarrelled with the farmer's son. He had been caught coming away from the farmer's fields, and in due course he had been arrested. Having been freed Thomas was a very worried man. I met him one afternoon and he asked me if I could get him off at his coming trial. My answer was NO.

I told him how he could stop worrying, and if only he did stop would he be able to come up with a reasonable excuse for setting fire to that rick.



I assured him that I was not going to produce any such excuse. I told him about pyramid powers and gave him the necessary instruction to build one. I told him how to ask for peace, and he decided to have a go.

The days passed and in due course Thomas went to court. Something very strange was happening; the case was adjourned for a month. At the end of the month the court could not sit for some reason which I never could discover. Now the strangest thing of all: a few days later the farmer was arrested for a major crime, and the case against Thomas was dismissed. Later Thomas came and thanked me for the help I had given him. He swore that I had used some sort of magic to get him freed, and although I protested that I knew nothing about any magic, he was not convinced. In the course of all this nonsense about magic I asked him how he had devised his word of power, and this is what he revealed to me.

I made a pyramid as you told me, I thought about the time I was first married and took my wife to the seaside on our honeymoon. I thought of the days by the sea, and presently I could hear the waves in my mind, and I wrote down, seaside, then put at the end the two letters E L. Well I had two E's so out one of them went. That left me with seasid, then I saw that there were two S's so out went an S. Now I had, Scaidel, and I twisted it a bit until I got, Sealed. And that is it, that is all there is to tell about it.

Not quite. He should have said that he carries that paper around with him, the paper with the word of power. Just one point: if the letters E or L are in the first word there is no need to eliminate them.

If a word like table should come up, the first L E should not be eliminated. The final letters would become T A B L E L E. This could be changed to L E T A B L E. or perhaps B A L T E E L. This should make it all clear. The East side of our pyramid is also the side for the emotion known as love. In this case your pebble should have the illustrated symbol. On the opposite side draw once more, in black, an egg-shaped oval. If you are using paper then these are the symbols to draw in apricot or light pink:

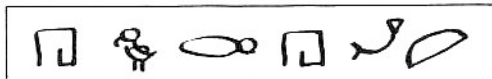
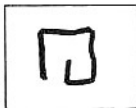

Screw your paper into a small ball and place it in the box on top of the pyramid. You must proceed now as in the first set of instructions, drawing your circle, the circle of Vayú. Relax for a few minutes, then think about

the girl or man you wish to respond to you. Finally recite this prayer, or Key as is sometimes referred to.

'Hathor, Sweet Queen of Beauty, thou who protects the weak. Be thou my shield and grant to me the love of (name of the person) guide her/him in the heavenly light. Assist me this day to attain the love I crave. Be thou my support when courage would desert me, nourish me with thy power.'

Now let your mind dwell on the person you love and form a mental picture to represent that picture. Write that word in pink on your paper within the blue circle, place it in your pocket or handbag and go about your business, trying to forget what you have done. A word here about the time spent in these rituals. You only need to perform any ritual once a week; choose your best day or evening and stick to that time. Do not be tempted to perform any ritual more than once a week. If results do not manifest themselves then first make certain that you are following the instructions properly. Then try again. Remember, it could be that you are not forgetting what you have done.

Hathor will come under the planet Venus. Those who have knowledge of the planetary influences can use any of the powers of Venus under this Key. The following may help those who are not familiar with planetary lore: Neptune grants weird and strange experiences. If working on any secretive plans, Neptune will help, but it should be remembered that Neptune must be considered as being virulently malefic. It can therefore be used in cases of poison or any terminal illness. It is one of the sexual planets leading to neurotic cravings, sex crimes and perversions. It will assist you to control these ailments and it will assist in bringing these desires to others. For those who take up painting, this sign will produce paintings of monstrosities or mysticism. It is the sign which the priests of old used in order to work havoc on their enemies.

I do not advocate the use of planets. This work is based on the knowledge left by ancient priests and there is reason to doubt that the influence of planets was ever used by these sages of old. For those who do wish to use planetary lore I will include the nearest likely planet, as is possible to ascertain from the influence of the Egyptian Pantheon.

After you have found peace of mind it is time to turn your attention to wealth. Wealth without peace would only bring you harm, that is why this book started with the East. We now turn to the north face. In the ancient occult traditions the north has always been identified with the element of

earth. It comes under the jurisdiction of the mighty angel Uriel. In the Egyptian hierarchy Anubis is the giver of wealth, so it is to this God that we must appeal if we are seeking wealth. The north is also the realm of Ptah, the architect of the universe. If we seek wealth and the ability to hold on to it, then this skill can be obtained through Ptah.

Case histories are useful to us. When we see what rituals have done for others we gain an insight of what can be in store for those who follow, so I will relate the case of Mabel C. Mabel ran a small flower shop. She loved flowers, she had saved all her life to get enough money to buy her business, she had put down all her savings as deposit, but although she worked long hours putting everything into the business, it did not prosper.

Despite her long hours of toil, Mabel failed to make much profit, bills began to mount up, her payments to the bank fell in to arrears. She obtained a little more time from the bank, she had used advertisements in the local paper, but fell behind with the monthly payment and the paper refused any more adverts from her. She sold some of her possessions to buy food, but worry and despair made her ill and the business closed.

I was asked by a friend to visit Mabel. She told me the sorry story of her downfall. I asked her if she had ever heard of pyramid power. She shook her head saying, 'No, never'. The next day I took my scrap book of pyramid technique to her. After reading it she made a small pyramid and practised the ritual for peace, after which she started on the north face. Today Mabel is a wealthy young woman. She is now the owner of four flower shops, she spends her time visiting the shops, but never spends a great deal of time in any of them. She can be found flitting around the town. The last time I saw her was in the largest and most expensive hotel in town. We drank a glass of sherry and she thanked me for lending my book on practice and results.

Bernard was out of work. He spent much time in the local library. Being interested in the magic of Egypt, he was devouring all he could find on that subject. Having read all he could find he asked me if I knew of any other source. I invited him to my residence and let him study some of my books. He was delighted, and reading about pyramid powers he asked if I had a model pyramid. Smiling I took him into my inner den and he gazed with wonder on the large model which I kept in that room. I told him to start with the east and when all worry leaves you and you are at peace with yourself and the world, then try the north face.

Bernard followed my advice. Three days later he came to me and said he wished to give me a hundred pounds. 'Whatever for?' I asked. He said that because of me and my pyramid he had won the Pools. 'I have won

thousands,' he said, 'and it is all because of you.' 'No,' I corrected him, 'not because of me but because of the spiritual influence of those ancient gods of Egypt. Anyway, I don't need money my son, I can always get money should I need it.' I never do need it, I always have more than I wish to spend.

The time has come now for you to inscribe the North side of your model. Just try to copy my illustrations. Do not worry if they are not exact copies, just do your best and the gods will forgive you.

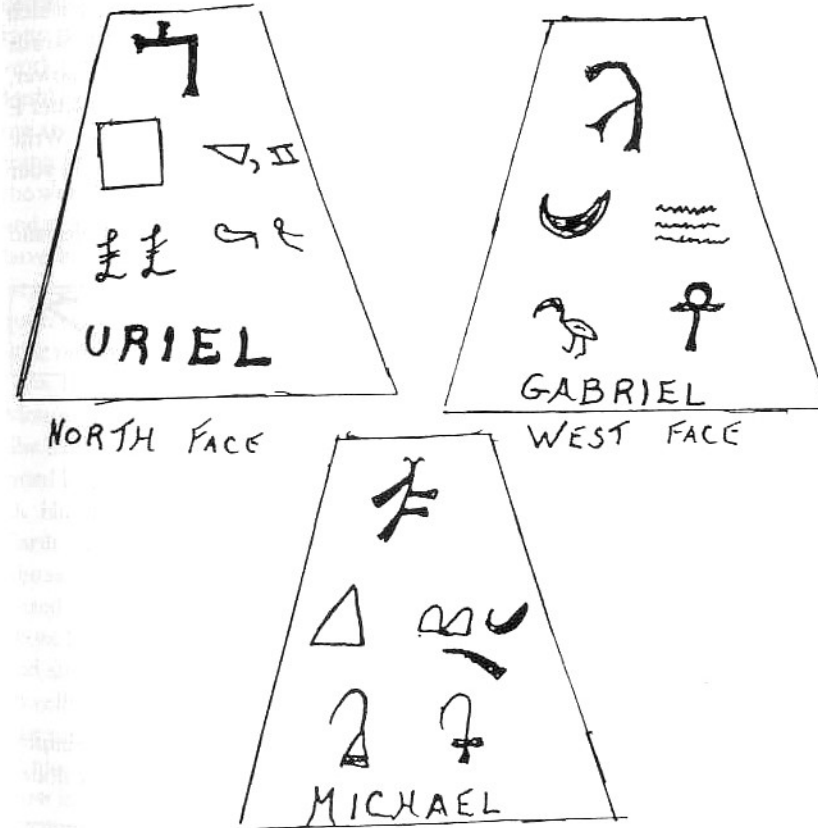

Starting at the top draw, in black, the symbol of earth. In the ancient language, underneath and to the right, draw in yellow the symbol for the element of earth, to the right draw the Egyptian hieroglyph for earth and land. Beneath and on the right draw the symbols for English pounds, and on the left the Egyptian symbols for knowledge. Finally, at the bottom,

write the name of the mighty angel Uriel. These various symbols will give you the best of both worlds. You have combined three distinct methods here: Alchemy, the Cabala, and, most important, Egyptian Magic.

The small box at the top should be inscribed with the name of the guardian angel of the earth, Phorlach, but you must write it in the ancient symbols left on this earth by that long ago race of super beings.

For your meditation take a piece of plain white paper, draw on it a yellow square as large as you can, sit quietly a few minutes to still your thoughts, then try to bring to mind a time when you had money or something which gave you much pleasure. Write on a separate piece of paper the words which bring this time to mind, then add E L and form your word of power, for example MONEYEL. No recurring letters here, for the first letter E does not have to be eliminated, so we could rewrite it as meloney. Write your final word of power in the square, fold the paper and place it in your pocket.

When you perform your ritual for wealth, take one of your pebbles and draw on one side in yellow the square, on the other side write the name of the Egyptian God Anubis in silver or white. If you have no pebbles paper can be used. If you have trouble writing the full name on your pebble write the first letter of the name using the symbol for A in the ancient language, as illustrated. Having prepared the way then repeat this prayer.



'Anubis, thou who we love most truly, thou who art a guide to the Gods, be my guide and protector through the dark pathways of adversity, help me to laugh at adversity and never fear the results of loss. Though my eyes should become dimmed by material gains, though my ears become deaf to the cries of the multitude, I beseech thee, bring me wealth.'

Now close your eyes, then gaze on your word of power, for two minutes only, place the paper in your pocket and try to forget what you have done.

Instead of Anubis, you can use the god Ptah, the giver of wisdom. The symbol for your pebble is illustrated. The prayer I will give later when writing of a special case. For the moment it would be wiser to remain with the God, Anubis. The inscription for your paper should be written:

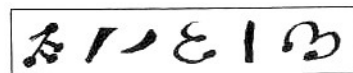

for Anubis

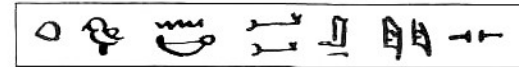

for Ptah

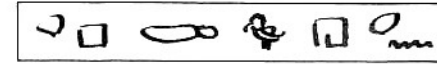

Do not forget that the symbol of Earth is used for both these ancient Gods. Let us, at this time, see how Susan found security. When I first met Susan she was in the depths of despair. She was so deep in debt that she was considering suicide. She said, 'What is the use of trying to carry on, there is no money in sight and no way of ever finding any. I have tried to find work and I am down to my last shilling.'

I told her not to despair and took her home with me. Together we entered my study and I introduced her to pyramid power. 'Now,' I said, 'the first thing I want you to realise is that you are overlooking the basic fact that the world is full of money. It is all around you, you only have to reach out and grasp it. The god Anubis has said that all who seek shall find. You have but to close your eyes and envisage wealth and you can have it, so sit down facing the North side of the pyramid, close your eyes and see yourself spending money. See yourself sitting at a table which is loaded with money, see yourself giving away handfuls of money.'

Now think of a word to bring that dream to mind. She thought that Monopoly would do, for that game has to do with money.'

She said, 'Yes, that is the word for me.' She added EL, and formed the word LOMNYPEL. Remember that she had to erase the recurring letter O. Having decided on her word of power she drew the yellow square of Earth and wrote within it her word.

She sat quietly for a few minutes, then repeated the prayer to Anubis. She gazed upon her word, folded the paper and, placing it in her handbag, went about her normal business of seeking work. I met her just three days later and she told me, bubbling with excitement, 'I have been offered a job, travelling around as an assistant to a buyer for a string of supermarkets. The salary will enable me to pay off all my debts and allow me to buy lots of nice clothes.'

Now is the time to finish the other two faces of your pyramid. Just follow the drawings. The west face symbol should be drawn in silver or white, the bird represents the ibis sacred to Thoth the Measurer. As this side of your pyramid is the side of the element of Water, all the symbols should be drawn in white, except the name of the angel Gabriel, which should be written in black.

For those who prefer to use the planetary symbols, the nearest to Anubis



would be Pluto, and the nearest to Ptah would be Saturn or Uranus. I wish you to remember that I do not really like linking the gods of Egypt with planetary or zodiacal rulerships. Actually, the pyramids belong to the Egyptian gods and it is impossible to make them really harmonize with planetary lore.

Looking at the Cabala, the name of the angel Uriel can be traced in the ancient language as VR or UR, relating to a strong seer.

Johnny W. was a salesman, who was not very good at his job. He came to me, full of troubles and woe, and asked if I could use some magic to help him sell more goods, or if I could tell about anyone who would assist him to do better at his job.

I told Johnny about pyramid power. He scoffed at the idea, so I said, 'If you know of a better way, then why come to me?' He agreed I had a point there, and said he was sorry. Would I help him? He was very surprised when I said NO. He looked so crestfallen that I said, 'Cheer up, Johnny, the reason why I will not help you is because you can help yourself much better by trying pyramid power.'

Johnny tried out the ritual to Anubis. It was not long before he had a new car and had been promoted to head salesman of the company. He now has all the money he could wish for, has a nice house and he told me that it wouldn't be long before he had paid off his mortgage. All this for spending about five minutes each week in prayer.

I used to chat to my hairdresser about things in general. He was a talkative old man and one day the subject of Egyptian gods came up. 'You know about them I believe,' he said. I admitted that they were a pet subject of mine. He wanted to know if it was true what he had heard about the old gods, whether they can give you money and things like that. I told him that this was true and gave him all the data he needed to build a pyramid. He used the following prayer to Ptah, and I wish he had not. Why? Because I have lost a good hair dresser. He has now retired, having won the football pools two weeks after using that prayer.

I wish now I had kept the information to myself - not really of course - but I do miss my chats with the old so-and-so. He not only won the pools but he married a young girl half his age and they are still touring the world. Here is the Prayer to Ptah:

'Ptah, divine builder of the Universe, help me to design my life according to your universal laws. Grant unto me the skill to build my life on a firm foundation, let me be a vessel of light that shines so that all men can see, that thou oh Ptah

can give spiritual and material guidance that leads into untold wealth with the wisdom to use that wealth to good purpose. Thou in whose hands rest the skills of invention and science, thou who holds the power over all things manual, grant unto me this day wealth and wisdom. In return I do honour thee, and now release thee.'

After repeating this prayer you should sit quietly for a few minutes. Then, holding the paper containing your word of power in your hands, imagine you are holding a vast sum of money, so much money that it is falling out of your hands, your hands are full and overflowing. Mentally say, 'This day I call forth wealth and prosperity to enter my life.' Then fold your paper and place it somewhere safe about your body, and carry it with you at all times.

Jane was a school teacher. She had been offered a better position in another town, but Jane wished to sell her house before leaving to take up this new position. Her trouble was to attract the right sort of person to buy her property. She really needed to sell quickly for she needed the cash to buy another house in the town she was going to.

Finally Jane decided to use pyramid power. She made a list of all the things she could do to help attract a buyer. Having done this she made a pyramid and appealed to Ptah to help her in her endeavours. A week later Jane received an invitation to a dinner party. While there she was introduced to a man who was seeking to open an estate agency; he was looking for property to sell.

Jane told him she had a lovely house which she wanted to sell, the man was impressed and told Jane to go ahead and buy the house of her choice in the town she was moving. 'Find the house and I will arrange all the details,' he said. Three weeks later Jane had purchased her new house and the agent had sold Jane's other house for far more than she had hoped to get. The client who bought Jane's house had found a lovely home, the estate agent had made a good profit, and Jane was ecstatic over the way things had gone.

Having finished your pyramid, now is the time to inscribe the last two faces of your open box.

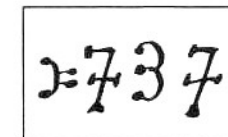
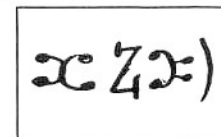

Each day medical science is discovering more and more that illness and disease is caused by our own wrong thinking. The mistreatment and food poisoning that we inflict on our bodies are the cause of many complaints. We have only to start thinking in a positive manner and many of our ills will disappear. The Logos of old taught that, if we tune in to the winds of space that flow across the earth, we can live a full happy life, free from disease and worry.

At the present day many are thinking along these lines. Even such terrible things as cancer are being treated with mental therapy and in many cases these malevolent disorders are being conquered by thought power alone. The Egyptians knew this. They first took the complaint to the healing gods. We know that they had success in surgery in those old days; it was a combination of skills, medical and priestly, that restored men to a happy, carefree life.

Henry had been injured in a car accident. For over three years he had lain on his back in pain. He underwent five operations, all to no avail. The doctors told him that everything possible had been done to repair the damage to his spine. They had removed pieces of bone from other parts of his body to use in his spine. His legs had been spliced and pinned with silver pins. In time he would be able to walk, but only with crutches, and they warned him he would always be in much pain.

As time went by Henry sunk into despair. He found that he could not walk any distance with crutches, the pain was overpowering, and he spent most of the days in a wheelchair. He spent much money consulting a specialist, who told him that the repairs to his body would not get better, but in time they would wear out and he would be confined to his bed.

Henry sought other hobbies. As he could no longer take part in the field of sport he looked around for a hobby which he could master sitting in his wheelchair. He took up model making and hearing about pyramids he decided to have a go at making pyramids. To his surprise, when he had completed his first model, he became aware of a strange feeling whenever he touched it.

Henry wrote to his local library and asked for books on pyramids. What he discovered changed his life. He did not really believe all he read but found no harm in trying these rituals out. Henry is walking without crutches today, without pain, and he has a very prosperous little business making models which are sold in the local shops.

It may surprise you to know that these healing powers are so strong that they are constantly circling the world looking for the sick. It could be that these unknown powers have brought this book to you. Why should I think

that? I have often noticed that, when a person has sunk to such a low pitch that life seems no longer worth living, in some strange manner that person is brought into contact with the powers of the unknown.

Perhaps it is because, when a person contemplates the taking of life through illness or poverty, his/her thoughts are attuned to divinity, unconsciously maybe, but nevertheless some power enters their mind and their thoughts go over the planes of thought, and they attract to themselves the relevant knowledge.

When Henry had recovered, he suddenly thought about a fellow comrade he had in hospital, and he thought that he has to go and see his old comrade in pain. The thought became so strong that Henry just had to go and visit his old acquaintance in hospital. He found him in the depths of despair. Like Henry he had been involved in an accident, and had both legs smashed. His knees were a mass of bone splinters and although the surgeons had done their best, his case was hopeless. They were considering the removal of both his legs.

Henry sat trying to comfort him, and in their talk the question of pyramids came up. Henry tried to persuade his friend to try the pyramid rituals. The man agreed, for there was nothing else left to try. He would willingly be a guinea pig and try out the rituals. It took a matter of months, but they did not remove his legs. They pleaded with him for his consent to the removal but he stuck to his desire to try pyramid power.

Today that man is walking around once more, true, he is crippled and his legs are not fully cured, but there is time on his side, and there is no reason why, as time goes by, his legs will not become natural once more. The fact that he can use them to walk after being crushed is a miracle, and there is no reason why that miracle should not become complete.

One of the symptoms of any illness is deep depression. This being the case, and to counteract this depression, I would ask you to read these case histories of what pyramid power has done for others. Just reading these cases will lift someone out of that depression. You will be able to contact the gods much more quickly when you are in a relaxed mood.

I appreciate that you may think they may not all be true, but every day you can read about miracles of healing. You can read how people, who have been blind for many years, suddenly have their sight restored. You can read about people dying from cancer, people who have been given only short weeks to live by the doctors, who suddenly become healthy again. Do not take my word for it, just read your daily papers, and when you read about these cases ask yourself who cured these people. Then read this book and make a pyramid, and tune in to the healing currents of the Logos.

I appreciate that you may think they may not all be true, but every day you can read about miracles of healing. You can read how people, who have been blind for many years, suddenly have their sight restored. You can read about people dying from cancer, people who have been given only short weeks to live by the doctors, who suddenly become healthy again. Do not take my word for it, just read your daily papers, and when you read about these cases ask yourself who cured these people. Then read this book and make a pyramid, and tune in to the healing currents of the Logos. Nancy was just a normal housewife going about her daily business. All was sunshine in her life, and then calamity struck: her husband became seriously ill. Paying the hospital bills took all their savings. He underwent surgery, made a recovery and returned home. He had no work and no money. The worry of all this caused Nancy to have a nervous breakdown. Things went from bad to worse. Her husband managed to find a job - loading furniture - but he was not really fit for such heavy work and after a few days he was off work again, having strained his back rather badly. Then came a large bill for rent and rates, followed by bills for electricity and gas, but they had no money left. At this time Nancy was in bed, really ill because of the worry of it all.

Her husband, seeking a light job because of his weak back, was out looking for work when a storm broke. Seeking shelter, he went into the local library, where he sat at a table, listless and tired. A book, left on that table, caught his eye. It was a book about pyramid building and the use of rituals. He became interested and when it stopped raining he returned home taking the book with him.

That evening he read through the book. It appealed to him and he left it for Nancy to look at the next day, as he had to go out seeking means of obtaining money. On his return he was surprised to find Nancy looking much better. When he enquired why, she told him, 'I read that book you have borrowed from the library, and I put my hands together in the shape of a pyramid and prayed to Bast, the Egyptian goddess. I dropped off to sleep within minutes and you know, I feel so much better, we must, really must make a proper model pyramid, for I know it will solve all our problems.'

They made their model and used the ritual to Bast. They formed their word of power and carry it with them at all times. What happened to Nancy and her husband? Having made their pyramid, that evening, before retiring for the night, Nancy performed the ritual of Bast. When she had settled down for the night her husband used the ritual of Anubis. He followed this by the ritual of Nephthys and he prayed for peace of mind.

Two days later he received a letter offering him a job at very good wages, a job entailing only book work. He accepted the job. The following morning he had an idea; he knew he had to go and have a chat with his bank manager.

Feeling a bit uneasy before meeting the bank manager he offered a silent prayer to Nephthys. He explained to the manager why he had withdrawn all his money, told him that he now had a well paid job, but had many bills coming in. Could the manager allow him an overdraft to meet these bills? His request was granted.

Nancy recovered. Working every day with the pyramid, a windfall came her way: she had entered a competition long ago and had forgotten all about it, when suddenly she was informed that she had won a car. A few days later she heard from a firm of lawyers that a client of theirs had passed away and in his will he had left a small fortune to a girl he had fallen in love with many years ago. To her surprise that girl was Nancy herself. The old man had never forgotten her. He had never married, had no relatives, and the money went to Nancy.

This is the prayer to Thoth, the Lord of Medicine.

'Hail to thee Thoth, Lord of Medicine, scribe to the gods, write well of me in your book, grant unto me physical and mental stability. Whatsoever I plan in spirit, let it be manifest on this earthly plane. Help me to learn the lessons set out by the gods. Bring unto me perfect health and let all disease and base thoughts be taken from me, and this day and forever grant me above all, faith in thee.'

This is the prayer to the Goddess Bast.

'Bast, most beloved of all the gods, mistress of the happy realm, thou who givest bounty to all, thou who art the twin of the sun, this day grant unto me the joy of song and dance, with thy powers slay the evil that afflicts the mind of man, with thy stealth thou wilt anticipate those who would move against me, be thou a guardian against all who would perpetrate cruelties towards the weak, stay their hands and let them not act against them. And please, oh Bast, implant within me a deep feeling of care for all other life forms.'

For those interested in planetary lore, the nearest planetary influence to



the powers of Thoth is Mercury. The planet Venus is likely to be in tune with the goddess Bast. And so to the south face of your pyramid: once more draw all the symbols as illustrated, starting with the top, which is the ancient symbol for Fire. Beneath and to the left draw the triangle in red which is the symbol for the element of fire.

To the right of your triangle draw the Egyptian symbols for resistance or attack and the symbol for battle and to strike or beat, for the south face is the face of offense and also of protection. Under the triangle draw the Egyptian symbols for fire, and finally add the name of the archangel Michael.

On the remaining face of the small box you write the name of the angel Aral. This must be written in the letters of that ancient race of super beings. Just follow the illustration and all will be well. If you think you are under attack by some unknown person, before attempting to find or locate that person you should use the ritual for protection. Remember, it is always dangerous to try to resist or attack on the mental plane until you are sure of your procedure. You may be attacking a person who has had years of experience in psychic warfare. Your best and safest plan is to sit facing the south face of the pyramid. In the box at the top place a pebble which has on one side the symbol for the goddess Isis shown below. In the

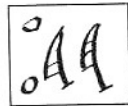

Egyptian pantheon she represents the high priestess, her nature being that of mother and protectress. On the remaining side draw either your initials or the symbol for fire, the red triangle. If you are using paper, write these symbols. Screw up your paper and drop it in the box at the top. Now sit quietly for a few moments, then place a piece of paper - about four inches square - on your table and draw a large triangle. Write inside it your problem or trouble. It is important that you formalise your thoughts on paper for this ritual. Do not try to make a word of power; you are dealing here with a high spiritual force and words of power are not needed. Now recite this prayer.

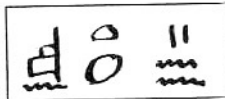

'Isis, blessed mother, protect me and mine from all evil emanating from an unknown source. Help me to seek out the lost fragments of my peace of mind. Help me, nurture me, and be my solace in this my trouble. Comfort me in the still hours of the night, take from me all thoughts of fear. Wash away my tears with your eternal magic. To thee blessed Isis I give my thanks, and from this time onward I

place my life in your hands, and now I release thee and thank thee.'

Now sit quietly and try to imagine a shaft of real fire leaving your body. Mavis was a pretty young housewife. Her husband had a good and well paid job, her two children were well behaved and doing well at school. Then, out of the blue, disaster struck. Mavis came to me with tears running down her cheeks. She was at the point of a nervous breakdown. That morning someone had left a dead cat on her doorstep, the morning before someone had written dirty words on her front door.

For several weeks an unseen enemy had driven her almost to the point of suicide. Her children had been attacked on the way to school and she had to take the youngest to the hospital to have stitches placed in her arms. They had been cut by the youth who attacked her. Mavis had reported these matters to the police but without some evidence as to who was responsible the police could do little to help.

Rumours had been started saying she had tried to cash dud cheques. It was false, Mavis had no reason to try to cash such cheques, for her husband's bank balance was quite sound. Then she found that her neighbours shunned her, and when she went out shopping they would cross the street to avoid her. They whispered behind her back that she was not all a wife should be.

Then her husband's boss was informed that he was employing a man who had been questioned by the police for a sexual offence. This was untrue but it caused a nasty feeling at the office where her husband worked. The result was that the boss, saying he was sorry, of course, but he really felt obliged to dispense with her husband. He could not have this kind of talk going around the office and being innocent did not make much difference. All that mattered was that the talking stopped.

Mavis kept a lovely flower garden, but now everything was dead. Some person had thrown acid over her beautiful flowers, and when she had gone to report this to the police, she had returned to find all her front windows smashed. Her litter bin had been emptied on her lawn.

I told Mavis about pyramids and how to ask Isis for help. She did not believe it but she would try and make a model pyramid. She was as good as her word and came to show her model to me. I gave her a pebble, inscribed with the symbol of Isis, and wrote out the correct prayer, telling her to pray each evening before retiring.

A lot of strange things began to happen during the next three weeks. First, her husband was asked to come and see his boss, he had his job back at a higher wage than he had before the mischief started. Then a neighbour's

house suddenly burnt to the ground. The chief of the fire brigade said that it was very strange, but nothing they could do would stop that fire. A youth in the town had an accident on his motor cycle, and at the hospital they found he carried a large knife. It was like the one her daughter had described to the police, and when a photo of the youth was shown to her daughter she readily recognised the youth. He was convicted of the attack on the girl and went to prison for a long time. Then a person was caught in the garden of the house of Mavis. He was cautioned by the police but before any further action could be taken against him, his car caught fire and he was badly burnt before he could be freed.

Mavis is well and truly happy now, everything is going along smoothly these days. Her husband has a new car and he has taken out a mortgage on the house in which they live. Her husband has been offered a directorship with the firm, and, to top it all, Mavis has won a huge sum of money on the football pools. And all this because she turned to the gods of Egypt for help, the gods plus a model PYRAMID.

Isis cannot really be linked to any planetary force, but if you must I should say that perhaps Venus would be best. Let us now turn to Horus. He is the warrior god, the great Avenger, he is the protector of homes. When you are appealing to Horus inscribe on your paper, which you will remember should be four inches square, the large red triangle.

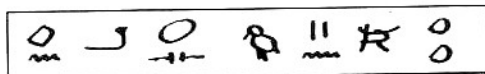



This is the name of Horus in Egyptian.

You are waging war on an enemy and you are asking for help to win this war. You do not need words of power, all you need is the name of your enemy and the symbols of war. You should also decide what you really wish your enemy. One very important thing: once you have decided, on no account change your mind, neither prayer nor pleading must you heed, **YOUR MIND MUST NOT BE CHANGED.**

Remember, you have enlisted the aid of one of the most powerful of all gods; he is not to be trifled with. It has been said by many that it is dangerous to invoke the ancient gods of Egypt. It is dangerous if you are merely trying for fun. Approach them seriously, with deep feeling and with respect, and no harm will befall you, but invoke them for pleasure and for fun and games and they are likely to destroy you. This is the prayer to Horus:

'Horus, radiant god, son of heaven, I beseech thee don thy

armour of radiant light, and help me to fight my enemy whose name is..... Heal me of any sickness or wounds, both of mind and of any physical nature. Revive me should I fall. Succour me in my hour of need. Grant unto me the power of your Utchat, that I may at all times be of good mental and physical health. This day I beseech thee go forth and destroy my enemies, strike them down wherever they foregather, pursue them, torment them, and finally destroy them. All these things I ask of thee with humbleness. Now having listened to my pleas, I ask thee to return to that blessed state above the sky.'

On your pebble for Horus draw a red triangle and opposite this draw the symbol  or  which is the eye of Horus.

When enlisting the aid of Horus, sit facing the south side of your pyramid and have in front of you a piece of paper four inches square. Inscribe a large red triangle, within this triangle write the name of your enemy, and inscribe these symbols of war:

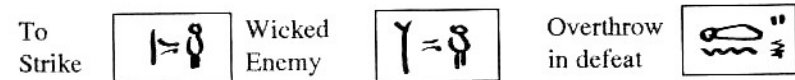

Then write AMMA be their MIR VNCHI DAZIS as follows:

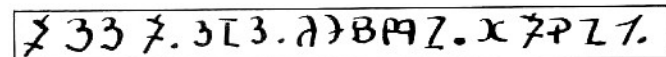

Sit quietly and try to envisage your enemy, see him being enclosed in a sheet of red fire, see him suffering torment, see him pleading for relief from pain, and when you have this picture in mind, then say, 'As it was in the beginning, so shall it be unto the last days.' You (here name your enemy) have chosen to be my enemy, I accept your challenge and this day I bring upon you the wrath of the gods. On your head be it.'

You should repeat this ritual nightly before retiring. Go to sleep with this ritual in mind and in a few days your enemies will be suing for peace. If you have invoked Horus, then there can be no peace, you must not change your mind. Should you do so you could find that the force you have invoked will rebound on your own head.

I think the nearest planetary influence to Horus would be the Sun. This sign would also belong to Osiris the last of our Egyptian pantheon.

Your pebble for Osiris should be inscribed in gold as shown. On the opposite side should be drawn in black an egg shaped oval.



For the god Osiris is the being linked between the earth and the spiritual realm, he is the king, the high priest, the father of the people. He can be used on all four faces of the pyramid, he belongs to all and he belongs to none. He should be looked upon as the creator of the universe. He must be regarded as the highest, the supreme, for if you cannot give him the status of god, then you should never call upon him. He is either the divine supreme being, or he does not exist in your workings. He must be honoured above all or he must be completely disregarded. There can be no halfway measure with Osiris.

Unless you are working as a group I would advise that you leave Osiris out of your workings; the force of Osiris can be had from Hathor and this is a much safer force to work with.

It is now time to get down to the real magic of Egypt, if you have not received the things you are wishing for, then you must get down to ritual working. It is not difficult, in fact it can be pleasant, and it is certainly rewarding.

The first step is to write down your intentions, all the things you want. Write them all down and think of all the things you would like to own, all the things you wish you could do; make a complete list. Now check through that list and decide which of these things you need first. Have you got a pressing problem? If so perhaps that should be your first ritual.

Let us start with wealth, for when we have a good supply of money we will be able to approach things with a much lighter heart. I realise you may have a more pressing problem. Just go through the following list until you reach your problem and apply it to the correct face of your pyramid.

Before we start I better explain what would appear to be a contradiction with other writers: it concerns the east and west side of your pyramid. All modern writers have placed the symbol of air and the Logo archangel Raphael in the west, whereas I have placed them in the east.

This arises because the data from which I have written came from pieces of ancient manuscripts, from old rock carvings, and paintings found in caves. These various symbols were inscribed long before the flood. In fact they were probably drawn before the sinking of Atlantis. I know that to date we have no real evidence for Atlantis, but there are written records which state that the earth suffered a real calamity in ancient days. There is a statement written by some ancient priest in which he states, 'That before that time of the calamity, the earth at first stood still and all was darkness (confirmed by Bible story that the sun stood still for 24 hours

while a battle was taking place) and when once more it became light there were high winds and floods, and before that time the sky was much lower and the sun rose in the west and set in the east...'

It would appear that the earth was knocked off course and then began to revolve in the opposite direction to its previous course. Present day scientists are in agreement with this. In fact they state that this has taken place on several occasions, and what is more, they say that the earth is due to roll over in the not too distant future. In fact there is already a distinct wobble detected at the North Pole, so it becomes obvious that we have no knowledge as to the original position of the east.

I say that it matters little, this business as to where is the east, as we are going to sit at our table looking at the pyramid. It is the face we are looking at which is important. The gods will hear us no matter which way we happen to be facing. We are calling them by name and symbol and as long as we call, we shall be answered.

The point is that strange powers emanate around any pyramid. Should you need proof of this then try this experiment: make a pyramid three times larger than your model and place under it or in it a piece of meat, a small dead animal or an egg.

No matter how long you leave the egg or animal, it will not putrefy. It will dry up and shrivel but never will it go off. Should you leave a knife or a safety razor blade within your model it will sharpen itself. This will be more effective if the blade is in line with the North Pole.

Should you be of a very inquisitive nature and love experimenting, make a large scale model of a pyramid, place within it a chair and sit in the chair for half an hour. You will never be the same again, so take care. But again I warn you, there are strange powers invoked in a pyramid, so take extreme care, do not approach this lightly. **YOU HAVE BEEN WARNED.**

Our needful desire at the moment is for wealth.

Place a large sheet of bright yellow paper on your table. Crepe paper is ideal for the purpose and is easily obtained and quite cheap. Spread this evenly over your table and place your pyramid in the centre of the paper, the south face towards you. This is the face of Horus. On a piece of plain white paper, about four inches square, draw a triangle in red. Within the triangle write the name 'Horus' in yellow and draw a small circle under the name. In the centre of the circle place a small dot, which can be drawn in black. It represents the Sun.

Place four yellow candles around the pyramid and one foot from it, say at the corners of your table. From a piece of the yellow paper cut a piece about six inches wide and fold into a thin strip. Wind this around your

forehead like a headband. Fasten it with a gold coloured pin. Take a five pound note or a one dollar bill and fold it into a triangle - just fold in half and then fold it from corner to corner along a diagonal. Place this note beneath your pyramid. Light your candles and use this prayer:

'Oh Horus, radiant son of heaven, once more I leave the busy world of everyday life and turn to thee in that blessed realm of spirit. I thank thee for another blessed day of life, and now like a child I turn to thee, help me to make the most of these few blessed minutes. Here on the plane of earth grant to me the wealth I so need to make my lot easier. Let me go forth refreshed, comforted, and with renewed courage, Oh Horus, thou art very real to me. Help me overcome my misfortunes, grant me your protection in all matters. With the coming of the new day, help me to commune with thee in the silence of my heart. Be with me at all times, lead me into paths of richness, let wealth come to me, each day, let me be richer in health and wealth. Every day through thy mercy I will become a better and richer person. Through thy help, from this day I shall not fail, but will succeed in all I do. Oh radiant Horus, I salute and adore thee. At all times will I carry on my person that symbol which above all others represents thee, Amen.'

Take the piece of paper from the top of your pyramid. On the the back of the paper you draw the eye of Horus. Fold the paper so that others cannot see what you have drawn, place it about your person and never let it leave you. You must repeat this ritual every evening before retiring for the night. And now, most important, DO NOT think about this ritual during the daylight hours.

One more point: always carry that folded banknote with you and do not spend it for at least three days after your ritual. Do not be tempted to spend it, place it folded in your wallet and keep it there during the day. You can use the same note each evening in your ritual, but after three days use another note.

This prayer is for the use of either male or female, but if you are a female do not use Horus, use the goddess Isis. Your paper should be inscribed within the red triangle, the symbols for Isis, given on a previous page. In the prayer substitute the name Isis for Horus. In place of 'Horus, radiant son of heaven' use 'Isis, blessed celestial mother, with your magic wash

away my tears, once more I leave the busy world...'

If you are invoking the aid of Isis, the paper and candles on your table will have to be clear blue.

You must remember that the south face is also the face of fire. It can be used to destroy your enemies. Before embarking on the trail of destruction you should ask of yourself, 'Has this person, or this group of people, or this situation, caused me any actual harm?' If the answer is yes then you should pray for help to evoke an equal loss to that group or person. 'Has this group or person caused me any mental pain?' If the answer is yes, then you should invoke the power of the red triangle of fire. Pray to Horus to release the scarlet triangle of Tejas for your use to destroy your enemy, but take care because, once released, this symbol will cause death by fire; it cannot be recalled. Do not use this method if you are not one hundred per cent certain that the person or persons are causing you pain.

If a person or a group are merely blocking your endeavours then pray to Horus to release his shaft of light on your behalf, this will not be so harsh, but will blind the person's insight. He or she will not be able to function against you, they will meet with fierce pain in the region of the eyes and head when wishing you harm.

You may be thinking that some person or group is opposing you and your efforts. You have no real proof of this but all the evidence would point to this, yet it is only circumstantial evidence. Here we have a case which needs enlightenment. What is needed here is divination, so we must turn to Thoth.

The colour of Thoth is silver. Obtain a roll of cooking foil. Cover your table with this foil, silver side up, dull side down. Place your pyramid in the centre of table. You now need four silver candles. Use white candles wrapped about half way up with the silver foil. After your ritual you must blow out the candles so that there is no risk of fire.

Sit facing the west side face of the pyramid. Place the pebble for Thoth in the box at top of the pyramid. Have a piece of white paper in front of you and on this inscribe the symbol of water. Cut out a silver crescent from your foil and glue it to your white paper. Also write the name Thoth on the same side of the paper; on the reverse inscribe the symbol of Thoth. Your prayer should be:

'Hail Thoth, lord of time and divination. What have you written in your book concerning those who may be enemies? First I would ask of thee mental stability. Grant unto me the information I need to make a sound judgement, for



I would not blame my enemies for what they have not done unto me.'

Now write on the reverse side of your paper, all the names of those you suspect of working ill towards you. After this sit quietly a few minutes then repeat three times this prayer.

'Lord Thoth, scribe of heaven, unto you I now dedicate my mind. I would ask of thee, carefully engrave on my inner mind the name of those who would deny me. I would command thee, send unto those persons they power of restraint, let them be wearied and fatigued by their efforts, abuse them and harass them. Let the evil they would wish on me rebound on their own heads. As a covenant between us I now light these candles.'

Sit quietly for five minutes. Then repeat:

'Hail Thoth, thou dog headed baboon, I now release thee, go in peace to that realm of the gods, until tomorrow evening when I will once again give homage and thanks to thee, Amen.'

To save repetition of prayers I will give a list of intentions which can be used under the heading of Thoth. Just repeat the main prayer and then use your own wording, finally ending with the last prayer.

Divination, intelligence and eloquence.

Promptness in business deals.

Science, wonders and answers regarding all future plans.

Also call upon Thoth in cases of theft, or deceit.

Also ask for help when writing.

If you are a female then in place of Thoth use Bast. In place of 'Thoth scribe of heaven' use 'Bast, thou cat headed goddess, patroness of song and dance.'

At this point I would like to tell you about Ron Hearsy. He spotted an advert in a magazine that promised to reveal to him a method of quick riches, and the secret of voodoo and magic. He wrote for details and in due course he met the leader of the group. Not knowing what he was letting himself in for, he joined the group, paying a large initiation fee. He soon found that he was paying a much heavier price. It was not so much the cash

but what he was paying in loss of respect. He found he was being dominated by powerful occultists and his life was being ruined by the performance of degrading rituals. Then there were the awful sacrifices and ceremonies he had to take part in, which soon were bringing him to the verge of madness.

It began to undermine his health and his nerves were in rags. The magic worked as promised, he was gaining wealth and power, but most of the power was taken from him by the terrible ceremonies and a large part of the cash was being absorbed to finance the group's activities. He decided that he had had enough. He told the leader he was through and was leaving the group.

The high priest just laughed in his face. 'You my son,' he said, 'you are a disciple of Satan and I as his high priest hold you in my power for life. Should you try to leave, you will find you are cursed and ill health, poverty, and trouble will follow you wherever you go. In fact, old son, you are doomed, you cannot leave now or at any time, try to leave and nothing but evil will be your lot.'

In due course Ron left the group. He said he was through with black magic for ever, but he soon found that all was not well. The group followed him and made his life hell. They used black magic to undermine his will. He even lost control of his bodily functions. He found that people turned against him and shunned him. He lost the will to live, lost weight rapidly, could not sleep, and started taking drugs to relieve his pain and sorrow. His car was sabotaged, the tyres were slashed, petrol was poured in his letter box, he was 'phoned at all hours of the night but on lifting the receiver only a hum was to be heard. Then he was beaten up by youths on the street. Evil smelling slime was poured through his door, his windows were smashed and then he received a note from the high priest saying, 'Come back to the group and all your troubles will cease.'

Ron did not weaken his resolve. He tried to counteract the evil by ceremonies he had learnt, but to no avail. He applied to occult seers, but with no result. He asked a priest to perform an exorcism, but all to no purpose. The priest could not help him because he had become an initiated disciple of Satan and the priest had no power over Satan.

This was the state of affairs when Ron was brought to me. When he entered my room a strong evil smell began swirling around the room and a mist seemed to form between Ron and myself. A scratching sound came from the walls and the door of my room. I offered a silent prayer to Horus the avenger, and the smell and noises ceased.

I instructed Ron as follows:

Go and made a model pyramid. On one face inscribe... (here I gave him the instructions for the north face). On your table place a violet coloured paper, in the centre of this place your pyramid. The north face must be facing you. At the corners of the table place four violet coloured candles, one on each corner.

Take a piece of plain white paper, four inches square, and on this paper write these symbols:

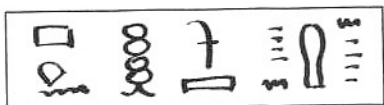

This will represent the goddess Ptah. These symbols should be drawn in violet. Also draw a square in yellow. Within the square write your own name in black, place this paper beneath your pyramid, close your eyes and pray.

'Oh divine Ptah, thou who art the power of the universal law, grant unto me, a forlorn human entity, who has grievously sinned in thy sight, skill to ward off my enemies. Plead for me with the mighty warrior Horus, protect me from the evil spirits which surround me.'

Sit quietly for a few minutes, then take a further piece of paper and on it write the symbols for Ptah. On the reverse side draw a triangle in red. Screw up this paper and place it in the box at top of the pyramid. Now light the four candles and pray.

'Oh divine Ptah, grant unto me the power to throw off all evil emanations, let my life henceforth be built on a firm foundation. Let your creative light guide me on my path to rise about this earthly torment. Grant unto me, peace in the still of the night, plead on my behalf with Horus, that radiant god to protect me at all times.'

Sit quietly a few minutes, then, pray.

'Oh divine Ptah, life is sometime very difficult, and I am afraid of what lies ahead of me. Only you and the all powerful gods of Egypt can banish that fear from my heart.

Enable me, oh Ptah, to adjust myself to meet the circumstances of each day as they arise. I pray to thee, asking humbly and simply for strength to face each coming day, and I pray that you will assist me to do my duty, no matter what the cost may be. Help me, a lowly human, oh Ptah. All this I ask most earnestly of thee. And now trusting in thee, I blow out these lights. Amen.'

Sit quietly and let your mind dwell on your enemies, see them being struck down by swords of fire, hear them pleading for mercy, hear their cries and revel in their destruction. Keep this up for as long as you can, but once your mind begins to wander, arise, leave your table and retire to bed. Do this for three evenings, miss two evenings and repeat for three evenings. Carry on with this until you feel your mind is at ease. Tell nobody what you are doing and try not to think about it during the day; go about your affairs in a moral way and await results.

During the day you should place your pyramid and papers in a drawer out of sight. Do not let any person touch your pyramid, candles or papers. They must be regarded as sacred at all times.

Three weeks after Ron started this ritual a strange thing occurred. One night the group, meeting in a wood, were performing their ritual sacrifice, when suddenly police appeared. They were arrested, the high priest received a prison sentence of seven years and his second in command received a sentence of five years. The other accolytes were heavily fined. Shortly after this the temple of black magic was burnt to the ground.

## The Master Ritual

Jack Seymour was 21 years old when we first met. He was downhearted the evening he came to visit me; despondent would be a better word. Jack was having no luck at all, nothing seemed to go right for him, but let him tell the story in his own words.

Ours was a fairly happy family. I had one brother and two sisters. My father worked in a garage as a fitter or mechanic. He earned a fair wage, he did not drink, except at celebrations or parties where he would have a glass of wine or beer. He smoked in moderation and was able to give my mother a good sum for house-keeping. Yes, my dad was a

good provider.

I was educated at a modern council school, was considered above normal intelligence and was fond of reading. At the age of sixteen I left school and was very fortunate to be offered a job in the local factory. After a year I decided that there must be a better way to make money than working five days a week at a work bench.

As I said, I was fond of reading and one evening in the local library I came across a book: 'Think you are rich and you will be rich'. I read this book over and over again. Here at last, I thought, was the answer to my prayer. I tried but couldn't make it work. From then on I have bought all the books on getting rich that I could lay my hands on. But they do not work for me. I get nowhere and now, at the age of 21, all I have to show for over five years of work is a stack of books telling me how to get rich; yet, there's nothing of the sort. Why?

'Not exactly a new story,' I told him, 'but let us analyze the books first. If the books are of American origin they most likely are revealing methods of salesmanship. The Americans are great fellows for selling insurance or real estate. Now if the books are by German authors then the emphasis will probably be on magic or witchcraft. Rugged stuff this but, in the main workable.

Should your books be British then they will be about psychology, super psychology, or mind over matter. All these books, no matter where they were published, have been written by people who have found a way to get rich quickly and easily. They have written these books to share their knowledge with you. Now, if the fault does not lie with the books, and we have to assume that the books are correct, then the fault must be within you.

Let us then look at your part. You tell me that you have read these books and have carried out the instructions faithfully to the best of your ability. Yet, you have failed to get the things in life that you so much desire. The simple truth, my son, is that you have a psychological blockage. No matter what you do, you will always fail to achieve your desires.

That statement is not exactly true. This blockage can be eliminated by psychoanalysis, but that entails around 400 hours of therapy and you will receive little change from £2,000. You are seeking money, not spending it. Do not despair, there is another way, a way so simple that I call it the

lazy man's way to get all he wants of the good things in life.'

5,000 years ago the priests in the temple of Memphis were extolling these words of wisdom: 'Ask of the gods and you will receive.' The Egyptians were great believers in the gods, they were devout in their worship, and so the kings, Pharaohs, and priests were the richest and most powerful people on earth.

The secret of gaining your heart's desire then is, if you cannot accomplish a thing on your own, to ask of someone who can help you. And who is more powerful than those ancient gods of the land of Egypt? However, it is no good just sitting back and saying 'I want this, that and the other.' To receive you must ask in the correct manner and the secret way to success is by the Master Ritual.

You are going to be put through a little trouble before commencing this ritual but, after all, surely its worth it, knowing that your very way of life will be changed for the better. Once you have the necessary equipment you need only spend about ten minutes a week. Ten minutes a week to gain the help of the most powerful force in the world.

These are the things you will need:

Six white candles.

A piece of turquoise paper about two feet square.

From a toy shop obtain a plastic dagger or one cut from cardboard.

Cut from cardboard five discs about two inches across.

You should wear a new bath robe and slippers.

You have been given instructions on building a pyramid. Now make one without cutting off the top, let this pyramid rise to a point. Now the hardest part of all: obtain a picture of the goddess Bast. The easy way of getting this is to ask a teacher to get the kids to draw a likeness of this goddess. I will give you a rough drawing of a Bronze figure of this goddess, copied from a figure in the British Museum.

Your drawing must be about twelve inches high, or rather the paper on which she is drawn should be that size. By the side of the goddess must be written these symbols:

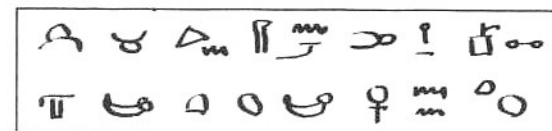

Translated this would read, 'May she grant all life and power, all health and joy of heart.' This is a true copy of the prayer to be found on the statuette of this goddess.

On the right hand side you must write these symbols.



Translated this reads, 'I am Bast, the Lady of Life'

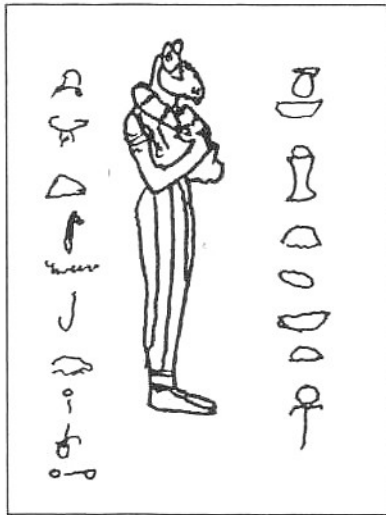

Having obtained these things we will proceed to the Master Ritual itself. First I should tell you that this is a true translation of the simple ceremony found on a stele in an ancient tomb.

On your table, which now becomes your altar, place the coloured paper. Stand up your picture, either by leaning it against some of your books or by making a support at the back of the picture. In front of the picture place your pyramid and place a candle on each side of this. Light the candles. Before you proceed, sit down and think. You must decide on a colour which in future will be your lucky colour, or a colour which appeals to you. Also, at this point you must decide upon a symbol to represent your name. Having done this, blow out your candles, colour your discs in the chosen colour and on them inscribe your symbol. You are now ready for the ritual proper. Just decide which evening you are going to perform it. Proceed as follows:

Place your coloured paper on your table. The table and the chair on which you will sit should be in the centre of the room. Place your picture of the

goddess upright in the centre of the paper. In front of picture place your pyramid. In front of the pyramid place the 'get rich' book you are most interested in.

On the book place the five discs carrying your symbol and lastly place your dagger in front. Place a candle at each side of your picture and light them now. Take up the other candles and place them on each side of the room - not in the corners. Light them.

You are now ready to commence.

Take up one disc and your dagger, walk to the candle which will be facing you when you are seated in the chair, this will be your north point. The candle behind you, when seated, will be the south point, the candle to your left will be the west point and the remaining candle the east point.

Walk to the north candle and place one disc in front of candle. Holding your dagger by the blade touch the top of the hilt to your forehead and say, 'Hail oh prince of the north, I call thee forth to watch over me and protect me from any evil emanating from the north.'

Take up another disc and go to the south candle, place the disc in front of candle. Touch the hilt of your dagger to your forehead, saying, 'Hail oh prince of the south, I call thee forth to watch over me and protect me from any evil which may come from the south.'

Take up another disc, go to the west candle, place the disc in front of candle saying, 'Hail, oh prince of the west, I call thee forth to watch over me and protect me from any evil emanating from the west.'

Repeat with your last disc going to the east.

Now approach the table, stand behind your chair, touch your forehead with the hilt of the dagger, then touch your left shoulder, then touch your right shoulder, touch your right hand and with the tip of the blade in your left hand place it gently on the table in front of the book.

Next sit in your chair, place your hands together let your fingers form a pyramid shape, and say this prayer.

'Hail to thee, oh beloved Lady, thou who art twin of the Sun God. Giver of life and happiness, granter of joy and song and dance. Lend me thine ear this evening. Truly I have set my symbol in the north, the south, east, and west, the symbol I now display to thee.'

Now take up your dagger holding it upright by the blade, touch your forehead with the hilt and say:



'Before me the flaming sword of truth and justice... Behind me the four sons of Horus... On my left the denizens of the underworld, to my right the gates of paradise. I hold this dagger, symbol of truth, so that the shining ones shall have no hold over me. With these words I banish all evil spirits from this room. Having now purified myself before thee, oh gracious lady, hear this my plea.'

Now, in your own words, ask of the goddess all that you require to make your life happy, ask for everything that you can bring to mind. Now place the dagger back on the table and use this prayer:

'Oh beautiful beloved Bast, help me, a lowly mortal, to gain the things written in the book before you. Failing this, grant me wisdom to distinguish clearly between the things of merit and those that are worthless. Teach me to value ideas and noble principles, that I may serve thee at all times. Life is sometimes most difficult and I am afraid of what each day brings forth. Oh Bast, divine Lady, help me to adjust myself that I will be able to meet the circumstances of each coming day. I ask of thee humbly and simply, help me to be earnest and faithful in all I do.'

Wait a few moments then:

'Oh Bast, I thank thee for lending me thine ear this evening. I now take my leave of thee, saluting thee and blessing thee. Amen.'

Now arise and go to the north candle saying, 'Oh mighty prince of the north, I thank thee and by blowing out this candle and removing my seal I dismiss thee, and bless thee that thou can go once more to your realm above the sky.' Repeat this for the other three candles. That is all there is to it. In about ten or twelve days you will find your life being changed for the better. You will gradually get all the things that you ask for, unless those things are a danger to you. In that case you will find that you are given alternative things in place of the dangerous articles. Each evening, on retiring, look at your picture saying, 'Oh Bast, from the abode at night I salute and adore thee, be with me this night and grant me the things I ask of thee.' Now go to bed and ask of Bast for the things you

need.

A final word of caution: do not ask for money, rather ask like this: 'Oh Bast, teach me the way to gather to myself wealth and happiness.' Do not ask for a new car, say, '... reveal to me the method by which I can gain a new car.'

I have given you an insight into the magic of Egypt. This magic has always been recognised as the most powerful of all magic. The ceremonies have been taken from ancient manuscripts and steles, from drawings and instructions left by various secret lodges. The symbols or letters of the ancient Egyptians are authentic. They have been taken from sources such as The Book of the Dead, and from tombs and writings which can be seen on the Rosetta Stone and from the papyrus of Ani.

I know from experience that this method works. I have named it the lazy way to get rich. Try it and the day will come when you will bless the day you read this book. Tell your friends about it, but don't let them get their hands on it, for this is one of those books that, if lent, is never returned. It is, of course, possible to use any of the other gods in the master ceremony, provided you use the correct colour. A far better course is to ask Bast to intercede for you, rather than to try to make up a ceremony to fit the chosen god. Remember, the master ceremony is an authentic ceremony, so if you wish to ask Anubis to help you find some lost article, it would be better to ask Bast to have a word with him on your behalf. If you should be asking Bast to intercede with any other god do please have on your table the name of that god in his or her correct colour.

I now take my leave, leaving you to get to know the gods of ancient Egypt, the gods that will never let you down.

Basil.

SEE FOLLOWING PAGES FOR DETAILS OF OTHER BOOKS FROM FINBARR. PRICES FOR U.S. READERS ON BACK COVER.