

# MINERAL ALCHEMY

(A PRACTICAL COURSE)

VOLUME 4 OF 4  
LESSONS 73 - 84

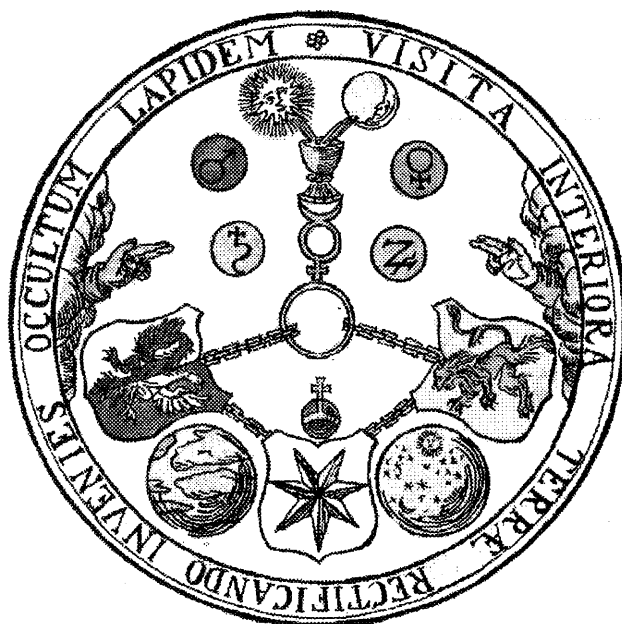

WRITTEN BY  
**JEAN DUBUIS**

TRANSLATED FROM THE FRENCH BY  
BRIGITTE DONVEZ

Copyright © 1987, 1997, 2000, Jean Dubuis. All rights reserved.

Triad Publishing

## FOREWORD

In 1995, the author of the present work wrote: "My name is Jean Dubuis. I am, this present day that I write, aged 76 years old, and I have a practice of esotericism of more than half a century. My esoteric researches started when I was twelve, after a tremendous inner experience; the invisible world had become for me as true as the world of matter where we live. From that time on, I never ceased trying to understand the nature of this experience, to find means to renew it if possible.

"This experience had shown me that there was another truth than the one of our visible world. I wished to be able to understand the nature and workings of this ordinarily invisible Universe. My researches started with books, where I didn't find much, so my early progress was rather slow. Much later, I found the only book that really helped me, the Sepher Yetzirah. After the ill success of books, I became a member of groups of Rosicrucian or Martinist spirit. I did not find really useful elements there. Their habit of illegitimate secrecy led me far from these groups.

"It is, in fact, a persevering personal effort that led me to renew my experience, and that resulted in my few contacts with the Eternity. From there on, I wrote three courses, one on Alchemy, one on Qabala, and one called The Fundamentals of Esoteric Knowledge. These lessons were finished some 15 years ago and I insured their distribution for 12 years. This work taught me a lot of things in the field of esoteric teaching. Today I have a lot to add to these lessons."

A resident of France, Jean has been a frequent lecturer in that country and in the United States. He was employed by a leading American electronics firm for 40 years, and has an extensive background in physics and electronics.

Jean founded a group in France around 1984 to disseminate his work, and to conduct group research. The association, Les Philosophes de la Nature, or LPN, ceased operations several years ago and was legally dissolved in 1999. Its English-language counterpart, The Philosophers of Nature closed on December 31, 1999. Triad Publishing is now the sole publisher of these courses for the English language, duly authorized by Mr. Dubuis.

Jean's research was based on some of the classical texts in these fields, such as the "Sepher Yetzirah" and works of MacGregor Mathers in Qabala, as well as "The Golden Chain of Homer" and the works of numerous alchemists including Flamel, Becker, and Hollandus. These courses are not, however, mere reworks of library books by some scholar. The emphasis of Mr. Dubuis has been in practical work, and the courses are meant to support experimentation.

Originally both associations sent the lessons a few at a time to their subscribers, so that one lesson was studied each month. It was required that the Spagyrics (Plant Alchemy) course of 48 lessons be received before taking the Alchemy course which expanded in time to have 84 lessons. Similarly, the Qabala course of 72 lessons was to be studied progressively. The course Fundamentals of Esoteric Knowledge was developed and eventually became a pre-requisite to the other courses. Dubuis wrote in the introduction to this course, "When we founded the association 'Les Philosophes de la Nature', no organization accessible to the public was in existence - at least in France - that clarified or disocculted esoteric disciplines such as Alchemy and Qabala. However, since esoteric and philosophical groups have been in existence for quite a long time, we assumed that the individuals who chose to join us had a certain amount of 'esoteric background and knowledge'. However, as time passed, it became obvious that, even though a number of members had spent a greater or lesser amount of time in such groups, most did not have the

esoteric knowledge we assumed they had when we wrote the lessons. The present class: 'Fundamentals of Esoteric Knowledge' is an effort to remedy this situation."

This course is, perhaps, Mr. Dubuis' finest publication to date. It provides a synthesis of a number of important ideas in esoteric studies, and provides a suitable foundation for a novice, as well as for an experienced worker to understand the courses in Qabala, Spagyrics and Alchemy. It does, however, stand alone as a course. We have heard from numerous long time students of esoteric groups who say that they have learned more from this course than in several years of study with their association.

Just as we will recommend that the course, Fundamentals of Esoteric Knowledge, be studied and put into practice before beginning the work of the Qabala or the Spagyrics and Alchemy courses, we must urge the student to work with Spagyrics before beginning the Mineral Alchemy work. This is for numerous reasons. The plant kingdom is traditionally where the principles and practices of Alchemical Work are learned. The plant kingdom is relatively safe for experimentation, and the costs are minimal because plants are readily available, and the equipment required is not particularly specialized. In this rather forgiving and gentle realm, a student can learn the skills and manipulations, which have many parallels in the work on minerals and metals. The theoretical aspects of Alchemy, which are the foundation for all practice, can be learned more readily using plants than with metals.

Further, the Mineral courses are written with the assumption that the person has studied all of the Spagyrics courses. There are many references to ideas and techniques which are explained fully in the Spagyrics course, and which are absolutely necessary to benefit from the course on Mineral work.

Our association with Mr. Dubuis began as earnest students of his lessons, around 1988, when they were first translated into English. Our personal relationship began in 1992, at a seminar in Canada, and we have shared many delightful and magical times together in the U.S. and in France since that time. We are grateful to say that our contact with our generous friend has stimulated personal transformation for ourselves and for many others.

Jean has often repeated the admonition that we must respect the personal freedom of each one on the Path of Return. We believe that the dissemination of these courses through the agency of a publishing firm, rather than through that of a fraternal group or membership association, will support that objective.

With good wishes for each in their quest for self knowledge,

Sue and Russ House  
TRIAD PUBLISHING  
May 21, 2000

TRIAD PUBLISHING  
INDEX OF THE MINERAL ALCHEMY LESSONS

**Volume 1:**

1. Circulatum Minor; Meditation # 1
2. Vegetable Mercury; Circulatum Minor; Elixir, Tincture And Salt; Meditation # 2
3. Alkahest Of Sulfur
4. Energies In Alchemy; Meditation # 3
5. Circulation Of The Elixirs; Meditation # 4
6. Use Of The Alkahests; Alkahest Of Tartar
7. Degree Of Vegetable Mercury; Meditation # 5; Prana And Kundalini
8. That Which Is Philosophical; Oratory; Laboratory
9. Vinegar Of Antimony; Extraction; Properties
10. Vegetable Stone; Ph Paper; Meditation # 7
11. The Philosophical State; Preparation Of The Metallic Oils; Aphorisms
12. Kermes; Regulus; Oil; Extraction; Spirit Of Sulfur
13. Symbols Of Traditional Metals
14. Preliminary Crystallization; Work On Wine; Extraction Of The Tartar Alkahest
15. Mercury; Antimony; Fixation On Its Salt
16. Deliquescence Of The Salts; Incubator
17. Vegetable Extraction
18. Vinegar Distillation; Preparation Of The Acetates
19. Elixir; Circulatum; A New Method For The Stone
20. The Golden Chain Of Homer
21. Separation Of The Three Elements
22. Artephius; Antimony
23. Dilution And Presence Of The Acetates
24. Lesson On The Different Ways Of The Acetates

**Volume 2:**

25. Comments On Lesson # 24
26. Comments On Lesson # 24
27. Comments On Lesson # 24; Night Contact; First Considerations About The Building Of An Oven
28. The Four Elements In The Elixirs
29. Chemistry And The Prima Materia
30. Operation Of The Blood Stone
31. Addendum To The Way Of Saturn
32. Extraction Through Aldehyde
33. Addendum On The Vegetable Stone And On The Fire Stone
34. Addendum On The Acetate Of Saturn
35. Aceton By Becker
36. The Origin Of Alchemical Knowledge
37. Becker (Continued); Philosophical Spirit Of Wine
38. Becker (Continued)
39. Name Of The 10 Kinds Of Gold Of The Sephiroth
40. Alchemical Aphorisms
41. Aphorisms By Urbigerus
42. Aphorisms By Urbigerus (Continued)
43. First Method For The Butter; Aphorisms By Urbigerus (Continued)
44. Sea Salt Acid For The Antimony Butter; Urbigerus (Continued)
45. First System On Butter With Hcl And Hot Stibnite
46. Resuming Lesson # 24 With The Kermes; Tincture Of Paracelsus; Antimony Butter; Work Of Hand
47. First Practical Method For The Butter
48. Butter And Deliquescence

TRIAD PUBLISHING  
INDEX OF THE MINERAL ALCHEMY LESSONS

**Volume 3:**

49. The Extraction Liquids; The Universal Salt Of Nature; Signs Of The Zodiac And Their Symbols
50. Extraction Of The Oil Of Mercurius Vitoe; Treatise On Salts By Basil Valentine
51. Distillation On Acetate Without Cold; The Book Of Formulas
52. Butter (Continued); Symbols In The Book Of Formulas
53. The Keys To The Work; The Book Of Formulas (Continued)
54. Four Causes Of Failure; The Nature Of The Putrefaction Of Elements; The Book Of Formulas (Continued)
55. Butter Distillation (Continued); The Book Of Formulas (Continued)
56. Fusion Of The Regulus; Preparation Formula; The Book Of Formulas (Continued)
57. Oven Of The Four Fires; The Book Of Formulas (Continued)
58. Method Of The Dry Way According To The Collectanea Chemica; Lead And Antimony
59. The Dry Way Of The Collectanea Chemica; Practical Elements
60. Recouping The Seed Of The Dry Way; Distillation Of The Mercury
61. The Subtle Distillations
62. Philosophy Of The Lessons; Astrology And Alchemy; Energy Circulation; Alchemical Initiation
63. Spagyrics Theory - 2nd Level
64. Laboratory; Oratory - Operation - Operator
65. Purification Of The Antimony Without Release Of Bad Odors
66. Fresh Plants And Celandine; The Stone Of Celandine
67. Ammonia Bubblers; Safety Measures For Mercury And Antimony Butter
68. Experiment To Explain The Theory Presented In The Collectanea Chemica; Note On Making And Recouping Antimony Butter
69. The Evolution Of Various Matters: Water, Sea Salt, Carbonate; Antimony Butter
70. Comparison Of The Elements Situated On A Same Column Of The Mendeleïev Table
71. Evolution In The Three Realms; The Role Of Fire
72. Ethics Of The Alchemist

**Volume 4:**

lessons 73 – 84 not indexed here.

# THE PHILOSOPHERS OF NATURE

Copyright © 1989 by LPN-USA

Lesson 73 - MINERAL - page 1

C.73.0190

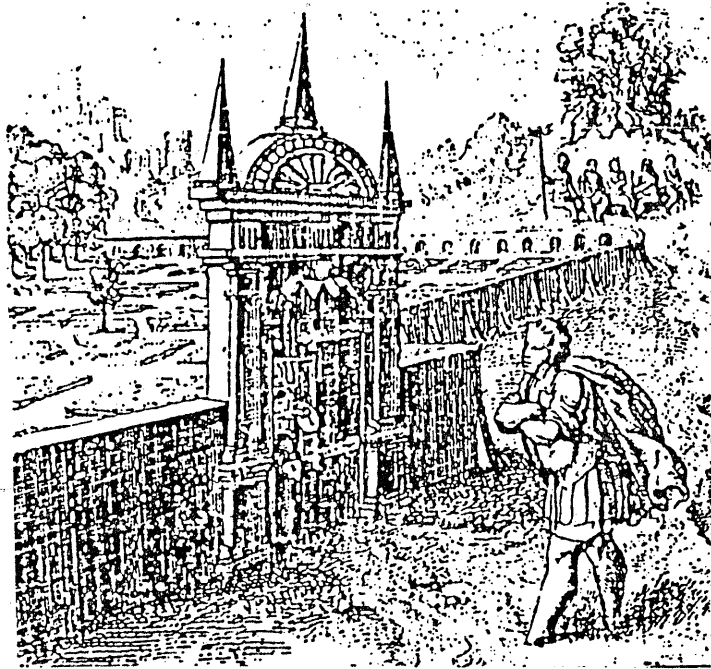

The student stands before the gate to Hermes' garden. Inside order rules and the Tree of Hermes grows. The dry water comes out of the garden under the door. On the outer mountain we find the five metals and the four elements.

**Note:** The illustration on the first page of this and of the following lessons deals specifically with the ways described in this addendum of mineral alchemy. They belong to a series of 25 illustrations from ATALANTA FUGIENS.

Dear Friend,

We ceased our lessons by Mineral Lesson # 72, although much remained to be said. There are two reasons for this interruption: first, and generally speaking we would like to not continue these lessons forever; and secondly, in the specific case of the mineral, the next lessons we had thought of sending, entailed high costs and some serious risks.

During this break we have found solutions to several problems. On the one hand, the cost of some material has been considerably reduced, (and if certain safety measures are taken, safety can be assured. On the other, we have taken up texts and experiments that we haven't yet suggested, and whose content it seems now appropriate to pass on. Furthermore, it appeared that the failures of works and studies performed by more than one lover of the Great Art come essentially from the lack of a general theory of alchemy. This lack makes texts even more abstruse than they already are. Therefore there is the risk in the experimental part of applying cooking recipes rather than striving to understand the whys and hows of the experiments. But when the theory dawns on you, then most texts become understandable and the why of the processes makes a lot of sense.

Taking the updated material into account, the 12 additional Lessons (# 73 to # 84) will deal with the following issues:

Alchemical theory:

- \* Study, decipher and understand old texts;
- \* Applying them experimentally and the explanation of the various and possible ways to operate.

Alchemical practice:

- \* Description of the material;
- \* Description of the experiments.

\*\*\*\*\*

\*\*\*

\*

## GENERAL THEORY OF ALCHEMY

Although in many instances (lessons, workshops, conferences, etc.) we have formulated various alchemical principles, it seemed useful to gather them below.

## The Goal of Alchemy

To help Man and Nature in the fulfillment of their Growth (Becoming).

### Basic Principles:

Alchemy states:

1. Everything issues from one single original energy;
2. There is life, consciousness, involution, and evolution in the three kingdoms: mineral, vegetable and animal;
3. The functioning of the three kingdoms is similar: only the levels of life and of consciousness change, and the effect of time depends on the level of consciousness. The mineral, less conscious, involves and evolves very slowly in time;
4. For man, the main point of alchemy is initiation. Initiation occurs essentially through two different processes:
  - a direct method by the use of elixirs and medicines reducing man's negativity (in himself) and his inner walls;
  - an indirect method which is in a way a shock of reaction. In his operations, the alchemist helps Nature which in turn and in response helps man on the path to his Growth.

Alchemy is essentially Initiation; a stone, whatever the kingdom it originates from, is an initiated mixture which consequently has a power of initiation in its own kingdom.

### Colors in the alchemical process:

In the alchemical process, just like in Qabalistic initiation, the elements of the work level are awakened one after the other.

The first phase, the "black stage of the work" is that of purification and awakening of the energies of the element Earth.

The second phase is the awakening of the energies of the element Water. The color is blue-green with a tendency toward blue in the vegetable kingdom and a tendency toward green in the mineral one.

The third phase is that of the awakening of the energies of the element Air. In the vegetable as well as in the mineral kingdom the color is yellow.

The fourth phase is the awakening of the energies of the element Fire. In the vegetable and mineral kingdoms the color is red.



In the white stage of the work, the element Fire is not sufficiently awakened for the red color to appear. Therefore, the power of initiation is weaker than in the red stage.

The processes leading the white to the red are in fact the operations bringing in Fire which, in the metallic realm, is even raised to the solar level.

## THE FIRE ENERGY

**First principle:** the Primordial Energy is divided into four kinds of energies: Fire, Air, Water and Earth which we have just mentioned. Fire and Air concern the spiritual elements, Water and Earth concern matter.

In matter, the active element of the preparation of the purification is Water. In the spiritual (the soul, the spirit) the active element is the Fire which operates the purification and the initiation.

The Fire Energy is the most important one for the alchemist because it is the most conscious and the most powerful; it is the only one with a true power of initiation in man and in matter. Therefore it should be the subject of a thorough study.

**Second principle:** the energy of the element Fire is transmitted to the earth through the sun. When it arrives in the earthly atmosphere, Fire is not determined, i.e. it does not belong to any of the three kingdoms.

If it is breathed by man or by animals, it is then determined in the animal kingdom.

If it is absorbed by the leaves of the plants, it is then determined in the vegetable kingdom.

If it is absorbed by the water of the rain, after running of and infiltration, it will be determined in the mineral realm.

Once determination has occurred, it is irreversible. For the energy to change its determination, it must leave the earth, return to its original state and start the cycle again.

This determination gives to the Fire energy a power of consciousness, which is weak in the mineral, medium in the vegetable realm, strong in the animal and at its strongest in man.

In addition, in each of the kingdoms, the energy Fire has several levels of resonance about which we'll say something further on.

The entire key to alchemy is contained in the correct manipulation of the energies through the various vessels.

### Manipulation of the Fire energy:

1. The transfer of the energy can only occur in the liquid state;

2- The solid state fixates the energy and prevents its returning to its level of resonance;

3- A mixture of solid bodies does not permit the energy transfer.

Examples for 1: (the words here must be understood in their old meanings)

The marcasites, insoluble bodies, cannot transfer their energies when in the state of matters.

- Marcasite: metallic sulfur (sulfide)

The vitriols, soluble bodies, can be dissolved and the transfer of their energies is possible.

- Vitriol: metallic sulfate.

The solid ores keep their energy, same with the snow. During fusion, the energy is liberated. Mercury, the liquid metal, has lost its energy and can only be revived if an energy that can be fixated is transmitted to it, which will then prevent its departing the liquid state.

Example for 3:

Transfer of the energy of the lead: galena, insoluble lead sulfide, will be transformed by soft and long calcinations into oxisulfide which, later attacked by the vinegar, will yield a soluble acetate making thus the transfer possible.

Analogy between the three realms:

The alchemical processes are always in agreement with nature. They only differ in the speed of execution. One of the first rules to consider is that the Creating Fire is stimulated, energized by the fire of the earth.

The fire of the earth is the little king of this world and it is the one which lights the Fire of the Great King. In this laboratory work we light up the small fire which lights up the great Inner Fire.

The Secret Fire or Sophic Fire is not animated in its natural state. Thus, in eggs kept in the refrigerator, the secret Fire remains non active. In that state the egg is not fragile and can even endure long term temperature variations.

When the fire of the earth has awakened the Secret Fire the latter becomes very fragile; very slight differences of temperature and short-term temperature variations are possible. Generally the temperature limits are those of the human body.

In the same way that in the incubator the temperature is maintained until the birth of the chick, so the temperature will be maintained until the maturation of the Work.

Fire and Qabala:

It is impossible to understand the alchemical phenomena very well without referring to the Qabala and particularly to the hermetic book of the AESH METZARETH (Purifying Fire). The Qabala says that the Universe is divided in 10 levels of energy condensation and that in each

of these levels there is an agreement between density consciousness, life, energy, etc... As for alchemy, it does not deal with the two highest levels.

The Qabala calls "Mezla" the Primordial Energy, and explains that this energy descends and becomes more dense always following the same path. The energy of Mezla constantly arrives and condenses on the earth. Then each solid mixture retains and fixates in itself the level of energy of Mezla with which it resonates until that metal or mixture has reached the level of energy that is correct for it.

To avoid too qabalistic a vocabulary, we will use for each level only the name of its metal or of its planet. So we have: Saturn, Jupiter, Mars, the Sun, Venus, Mercury, the Moon, the Earth or: lead, tin, iron, gold, copper, mercury, silver, antimony.

In each level, the four elements are present and are in agreement with that specific level.

In each level, Fire is the element of power, it is the master of the level.

In addition there is a hierarchy in the levels because each of them transcends the ones that are inferior to it. This illustrates what the Ancients say about Saturn, i.e. that it is the Medium Cœli, that it is the most powerful and that it is the only one to access all the laws of the manifested world. That is why, in Saturn, the Fire of lead is the most active alchemical element and will be used in a path of the descent. We start from the highest element to reestablish one after the other the successive lower levels. The trouble in the descending ways is that the volatile Fire is very very difficult to fixate. But an ascending path is also possible like the one of antimony.

\* \* \* \* \*  
\* \* \*  
\*

## ANTIMONY OR THE LEAD OF THE SAGES

All processes based on antimony will obligatorily be processes of the reascent.

Basil Valentine says that antimony has seven planets, seven colors, and the explanation of it is as follows: with each step of its descent the energy is marked by the level it goes through, i.e. the energy arriving at the level of the sun, for instance, is already marked by Saturn, Jupiter and Mars. Thus when the energy arrives at the level of the Earth there is incorporation into the antimony and it has then in itself the marks of the seven planets, of the seven traditional metals.

Fundamental principle of the work on metals and secrets of the antimony:

If we melt a metal (liquid state), the energy is no longer fixed, it is released at its planetary level. Thus, the fusion of iron releases the energy at the level of Mars, the fusion of galena releases that same energy at the level of Saturn. In these two cases, the Fire reintegrates the higher worlds and thus becomes inaccessible to the process of the physical world of man. But the

fusion of antimony, for one, releases its Fire which remains in its world: the Earth, since it is its level. That is why antimony is the only metal that undergo fusion without losing its Inner Fire, which does not mean that some kind of carelessness or clumsiness cannot burn it up.

We need two elements in the experiments: the Fire of antimony in the ways of evolution: or the Fire of antimony and the metallic "seed" in the agricultural ways, i.e. the ways of the matrixes where the seed will produce the metal from which it is issued. It is the same thing in the ways of the amalgams and of cinnabar, which we shall see later.

### THE MINERAL SEED

In the egg, the support of the seed is the sperm but the true seed belongs to the domain of the Invisible, it is the Secret Fire determined in the animal realm. This Fire is first inanimate and the earthly fire of the incubator renders it active.

In the seed of wheat for instance, the phenomenon is the same, except that the Secret Fire is determined in the vegetable kingdom and that the humid heat of the earth animates it. This secret Fire is also determined by its support, the grain of wheat, its "magnet". The Fire determined by the grain of wheat can only produce wheat.

In the mineral realm, the Secret Fire, first undetermined will be first determined in the realm itself, and then into a metal. Thus only the Secret Fire determined for silver will produce silver; only the Secret Fire determined for gold, will produce gold, and so on.

But we should note a very important point here, that is, if the determination of the Fire in the mineral realm is irreversible, it is not the same with the determination of a metal. Which explains that Mezla, the secret fire, goes through the successive determinations of the seven metals before completing its path in antimony.

Recouping of the various elements of the scoriæ is in fact recouping the supports of the metallic seed. This seed must be revived in the process of the amalgams by the Fire of antimony which has been transferred by the Philosophical Mercury in the seed. Then, the support will determinate the metal produced for the energy, generally silver or gold. But the choice of another support could lead in principle to the generation of any other metal.

In this process the metal produced is an "initiated" metal.

We must take note that to awaken the Secret Fire the temperature is increasing according to the kingdom: vegetable, animal, mineral.

Ora et Labora!

THE PHILOSOPHERS OF NATURE.



# THE PHILOSOPHERS OF NATURE

Copyright © 1989 by LPN-USA

---

MINERAL - Lesson 74 - page 1

C.74.0290



The Alchemist must follow the path of Nature but with the light of Knowledge.

Dear Friend,

## THE TABLE OF MENDELEEV

The alchemical operations are operations on life, in order to give a start to evolution, or for operations with an aim comparable to vegetable germination.

We are going to study this process with the help of the table of the chemical elements, called the Table of Mendeleev or The Table of the Elements (see Figure # 1) but we will consider that one column represents one function of life in the universe and that a line deals with the density of a kingdom.

### Column IV

Animal or vegetable life rests on so-called organic chemistry whose basic element is carbon, positioned in that column.

Recently, a new chemistry has appeared, that of the silicons whose bodies have great similarities with those of organic chemistry, with the additional feature of being more heat resistant. We must note that this chemistry is based on silicon, element located in column IV like carbon but on a lower line.

If we examine in this column the still lower levels, we have three metals: germanium, tin, and lead. In the alchemical experiment of attempting a transfer from vegetable life into mineral life, this kind of solution will only be applicable to these three metals and particularly to lead, because their outer electronic structure is similar to that of carbon: 4 electrons.

4, number of the quaternary, domain of man's evolution.

### Column VI

The other important element of organic chemistry is the oxygen necessary for life.

The breathing of oxygen in the animal realm provokes the appearance of a toxic substance which stops life and consequently evolution (a carbon-oxygen combination). If we examine the mineral realm, a majority of minerals are sulfides, they evolve and live in this form. The sulfur is the oxygen of the mineral realm. If you visit a mine of antimony, you can observe that the "mineral breathing" releases a strong odor of sulfur and that the blocks of minerals are surrounded by a kind of sulfurous gangue, a poison resulting from metallic breathing and which we must get rid of before any attempt at revivifying.

When a man has been asphyxiated the breathing of new oxygen helps to bring him back to life, in the same way a pure and native sulfur helps to revivify the metal.

The oxygen has the same outer electronic structure as the sulfur, 6 electrons.

6, a symbol of the link between the two worlds - spirit and matter - through the hexagram.

### Column V

This column is that of the animating bodies (niter or nitrogen) in the three realms. Nitrates are the basis of fertilizers, so are phosphates. We should also note that these two bodies have links with the element Fire that they can activate. Nitrates are all more or less explosive and phosphorus is used to make matches.

In this same column we find the heavy elements: arsenic, antimony, bismuth. But only antimony has the characteristic of having, in the mineral realm, a function similar to that of nitrogen in the vegetable realm. It will activate metallic evolution and it will bring in the necessary Fire. Antimony in alchemy in the "mineral fertilizer".

The outer electronic structure of these bodies has 5 electrons.

5, number of man and of the pentagram.

### Column I

This one is the column of fire. Hydrogen is considered the best carrier of the undetermined element fire.

The lithium, dangerous to manipulate in spagyrics, has little interest for the alchemist.

Soda (or its salts) is one of the "alchemical magnets" that is to say that it will attract by deliquescence the Fire of the atmospheric air and will determine it for the animal realm through sodium chloride or sea salt.

Potassium is another magnet particularly in the case of potassium carbonate which will determine the Fire in the vegetable realm. As for the three metals of this column: copper, silver and gold they can by the agency of fire reach the top of the metallic evolution. A later study will resume this point in detail.

The single outer electron of these bodies is the symbol of their link to Unity.

### Column II

This column contains mercury, sole metal liquid at room temperature. The other metal of this column used by some alchemists is zinc.

Note that in this number 2 column - the number of duality - we find the only metal considered androgynous by alchemists. Note also the fact that its atomic number 80 is close to that of gold 79 and that of lead 82.

The mercury  (the Moon, the Sun, the cross of the four elements) is the symbol of the organizer of the alchemical marriage).



In this column there is also iron, the metal of magnetism. In the three realms, life is electromagnetic. The Fire is the electrical element, iron brings in the magnetic element.

### Column VII

The interesting bodies in this column are chlorine and bromium.

The chlorine is called by some authors the "Green Lion" because in its native state its colour is green and because it attacks all metals, except gold. Combined with niter or nitrogen, it then becomes aqua regia, the solvent of gold.

We should note that while carbon is the basic element of organic chemistry and that it is sufficient for vegetable life, animal life on the other hand requires the presence of chlorine through the sodium chloride of the blood.

The ancients often mention the acid of sea salt, either  $Cl H$  or  $7 + 1$ , or  $8$ , twice the number of electrons in carbon.

### Column III

This column contains no interesting elements in alchemy. It is very possible that it is best to avoid their presence.

Just like boron, at the bottom of this column, stops nuclear reactions, so the bodies of this column must be a part of the elements stopping metallic evolution. Thus do not put aluminum in contact with alchemical metallic products.

The study of the bodies of this column confirm that borax must definitely be avoided as a fluxing agent. If it is used and that we can successfully eliminate it completely, it makes the alchemical process inoperative (antimony glass of Basil Valentine).

### Practical conclusion

If we operate with a 4-electron metal and with vegetable life, the function of sulfur will be taken by oxygen, which is the case with the minium treated by the red oil of antimony.

For any other metal revived by antimony, the "metallic breathing" will be assumed by sulfur.

The minium evolves through the vegetable life, therefore it consumes oxygen.

Mercury evolves through the mineral life, therefore it consumes sulfur.

### Comparison of the three realms.

Experience shows that the most profitable study for alchemy is that of the vegetable realm. The speed of evolution in this realm is sufficient for man to be able to observe the results and the mechanisms.

The animal kingdom is interesting with regards to the issue of fecundation.

The mineral realm has in its natural state such a slow evolution speed (millions of years) that it is not perceptible to man.

The alchemist must then examine the functioning of the vegetable seed during its growth in order to know how to apply it in the mineral realm so that the speed of evolution of the latter become comparable to that of the vegetable realm; given that the bodies in the bottom of the columns of the Table of the Elements play the same role as that played by the bodies at the top of the columns in the vegetable kingdom(except for column VII).

\*\*\*\*\*

## THEORY AND PRACTICE OF THE SIMPLEST VEGETABLE STONE

We are adding this document in the lessons; it contains important additional information.

An alchemical stone is a mixture which has been initiated and which consequently can transmit initiation in its kingdom and at its own level.

### Plant used:

Among the best plants leading to the vegetable stone, we must remember lavender (flowers), caraway (seeds) and cumin (seeds).

### Theory of the Vegetable Stone

Two conditions must be met in order to obtain a stone from a plant.

1. All the scorix and negativity of the plant that has been accumulated during involution must be eliminated;
2. After the purification, the plant must be charged with the element Fire at a sufficient rate to give it the power of initiation in its kingdom. Otherwise the stone cannot extract or purify the elements of a plant in aqueous digestion.

The proper charge in Fire is translated practically by the fact that the stone is not soluble in water.

### Operative mode for the suggested type of plants.

Have at least 5 kg of flowers or seeds no more than one year old. Here we are using caraway seeds.

### Operation 1: Extraction of the essential oils

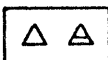

- Divide them in two parts: one of 4.5 kg the other of 0.5 kg;

- Extract the essential oil from the 4.5 kg part with steam but without injection of additional steam. This in order to avoid too great a volume of water in the flask;

- As soon as the extraction of the oils is complete, dry out the seeds + the extraction water together. The water containing the salt of the plant should not be separated. Do not let any fermentation or putrefaction of the fæces set in;

- For the duration of the dessication, reinstall the oil extractor but with a smaller flask, one liter for example;

- Fill the flask half way with distilled water. Pour the essential oil on it. Distil them by boiling the water, always without injection of steam. If there is a mark of colour on the flask at the height of the surface of the distilled water, start the distillation again until this mark no longer appears. At that time, the oil must be as clear as absolute alcohol.

These purifying distillations of the essential oils must be performed rather quickly, otherwise the oil evolves and the losses are important. A maximum period of one week for all these distillation seems appropriate.

#### Operation 2: Salt extraction

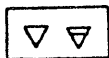

Before you begin the extraction of the salt, some preparatory measures are necessary in order to obtain a maximum of Fire in the plant.

A very important principle which should always be respected afterwards is that each time it is possible, the crystalline state of the matter should be preferred over the amorphous state. In fact, order is better than disorder. When a crystal is folded, its atomic crystalline structure remains in the smaller pieces.

To increase the charge in Fire, the following operation is recommended:

- In a large opening container, dissolve until saturation potassium carbonate in water at 90-95 C;

- Let it cool down as slowly as possible. In the cold, crystals form, collect them, and drain them in dry atmosphere;

- Set the crystals to deliquesce preferably in the weeks following the spring equinox;

- Distil the "oil" of the deliquescence (oil of tartar);

- Recoup the carbonate and the water, as the two are charged with Fire.

During this time, the calcination and trituration have yielded a pale grey to grey powder from the extractions water and the seed. Extract this powder in the soxhlet with distilled water:

- Be careful do not saturate the water of the soxhlet. When the extraction ceases, calcine the powder again at a high temperature 600-650 C and stir it to oxygenize it and start the extraction again;

- Bring all the salts extractions waters together and evaporate without boiling in a large opening glass container;

- Reduce the volume of water by half and let it cool down. If crystals form, separate them;

- Reduce to a third of the initial volume of water and separate the crystals;

- Reduce to a fourth of the initial volume of water and separate the crystals, then evaporate in a dry atmosphere.

All the white crystals can be chosen. Dissolve them, filter the solution and crystallize a second time. For the coloured crystals, even if slightly coloured, calcine them, dissolve them, filter and crystallize until they are in turn purified.

In the entire series of operations, remember that the first crystals formed are the purest. Plan to use only half of the crystals because we want to obtain a perfectly pure salt.

A last dissolution of the crystals is done with the water proceeding from the distillation of the "oil of tartar" the so-called "angels' water" and the crystals are charged with Fire for the first time.

### Operation 3 : Imbibition of the salt by oil

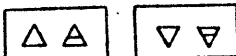

The imbibitions may begin. The Salt is imbibed by the oil until it is saturated but no oil should not remain at the surface of the water. Put into an incubator for seven days at a temperature of 37-39 C. The Secret Fire will awaken. The Salt will open up. Thus, the greatest precautionary measures must be taken to avoid bacterial contamination or contamination by a parasite sulfur (see Figure # 4). To prevent the anti-contamination container to cool down, it can be placed in water at 37-39 C. The imbibitions continue until complete saturation. At that moment the situation is as follows:

The Salt is imbibed by the Sulfur, the four elements are present like this  $\Delta \Delta | \nabla \nabla$  but the element of junction between the Sulfur and the Salt is not there.

### Operation 4 - Extraction of the tincture

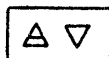

Now we will extract the tincture of the 500 gr of the plant put aside. A soxhlet is charged with the plant and a very high percentage alcohol (99.7 - 99.8 %). The alcohol has been obtained by digestion on potassium carbonate set to deliquescence then dried up and calcined.

The Fire attracted by the magnet - potassium carbonate - will be determined in the vegetable realm and thus this alcohol cannot interfere with the vegetable energies of the plant. In addition, this alcohol of very high percentage will prevent extraction of an impure salt which could later on jeopardize the Work.

The last digestion of the alcohol will take place with the carbonate obtained from the oil distillation.

Several extractions with the same alcohol will be necessary because the later must be saturated, this can be seen by the important deposits on the surface of the flask. These extractions must be performed in a water bath.

The tincture won't contain any impure Salt, or very little, on the other hand, it will be charged with impure Salt.

We will now see a phenomenon identical to the one that takes place in the tincture-salt circulation, where the salt only fixates the elements that corresponds to it.

Perhaps you have tried to recoup the alcohol of old tinctures. Experience shows that the purification is impossible because the alcohol has fixated the pure mercury of the plant.

We must therefore distil the tincture without ever pushing it to the dry point, for example, by stopping at about 1/10 of the volume the first time and then at 1/20 the following times. In these conditions 7 distillations are sufficient.

#### Operation 5: Imbibitions by the Mercury

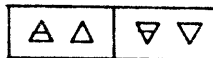

We must now start the imbibitions again with this mercurial alcohol. Proceed as for those of the oil, be as careful and set it into an incubator for a week. The goal of these imbibitions is to reestablish the Sulfur-Salt contact to arrive to the following principle:



#### Attempts at a Vegetable Stone

The saturation of the Salt by the Sulfur has made the latter insoluble. The Sulfur-Salt junction by the Mercury brings the fusion temperature of the stone down.

If there is any solubility, start the oil imbibitions again which will become possible after the action of the mercury. If the fusion is not easy, start the imbibitions of the mercury again.

For the attempts at extracting the elixir with the stone, start with a lunar stone and then proceed with a series of attempts ascending the sephirotic levels one by one.

The stone cannot extract an elixir which has a sephirotic level higher than its own level of initiation.

For healing, a small bit of the stone is more efficient than an elixir. This stone of mercurial caraway can extract only the Moon and Mercury levels, but its action on the Sephira Hod (Level 8) produces an improvement of the alchemical and magical talents.

Ora et Labora!

THE PHILOSOPHERS OF NATURE

Enclosed Figures:

- I - The Table of the Elements
- II - Comparison between the sephirothic levels and the number of outer shell electrons
- III - Operations for the simplest vegetable stone
- IV - Anti-contamination device

Figure # 1  
C.74.0290

THE TABLE OF THE ELEMENTS

Period	Group I		Group II		Group III		Group IV		Group V		Group VI		Group VII		Group VIII		Group 0	
	A	B	A	B	A	B	A	B	A	B	A	B	A	B	A	B		
I	1 H																	2 He
II	3 Li	4 Be			5 B	6 C			7 N	8 O				9 F				10 Ne
III	11 Na	12 Mg			13 Al	14 Si			15 P	16 S				17 Cl				18 Ar
IV	19 K	20 Ca			21 Sc	22 Ti			23 V	24 Cr				25 Mn	26 Fe	27 Co	28 Ni	..... 36 Kr
V	37 Rb	38 Sr			39 Y	40 Zr			41 Nb	42 Mo				43 Tc	44 Ru	45 Rh	46 Pd	..... 54 Xe
VI	55 Cs	56 Ba			57 à 71 Lanthanide	72 Hf			73 Ta	74 W				75 Re	76 Os	77 Ir	78 Pt	..... 86 Rn
VII	87 Fr	88 Ra			89 à 103 Actinide													

COMPARISON BETWEEN THE SEPHIROTIC LEVELS  
AND THE NUMBER OF OUTER SHELL ELECTRONS

Sephirotic level	Metal	Number of electrons				Number of electrons
	Planet					Element Fire
						Hydrogen <b>1</b>
						Potassium <b>1</b>
<b>3</b>	Lead Saturn	<b>4</b>				Sodium <b>1</b>
<b>4</b>	Tin Jupiter	<b>4</b>				Chlorine <b>7</b>
<b>5</b>	Iron Mars	<b>2</b>	Red	White		Life Element
<b>6</b>	Gold the Sun	<b>1</b>				Carbon <b>4</b>
<b>7</b>	Copper Venus	<b>1</b>				Nitrogen <b>5</b>
<b>8</b>	Mercury Mercury	<b>2</b>				Sulfur <b>6</b>
<b>9</b>	Silver the Moon	<b>1</b>				Oxygen <b>6</b>
<b>10</b>	Antimony the Earth	<b>5</b>				



Figure # 3  
C.74.0290

OPERATIONS FOR THE SIMPLEST VEGETABLE STONE

**Operation 1:** Steam extraction of essential oils  
Purification of the Sulfur through 5 to 7 steam distillations.

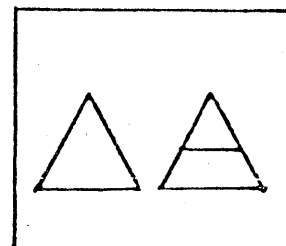

**Operation 2:** Salt extraction and purification through crystallization.  
The Salt is charged in Fire by the "angels' water".

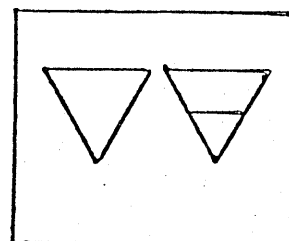

**Operation 3:** Imbibitions of the Salt  
by the Oil.  
(Salt and Sulfur are ready but not united)

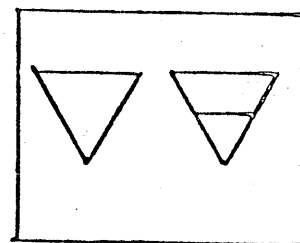
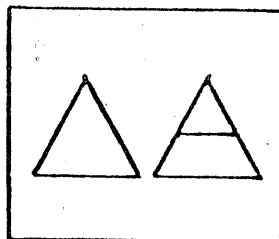

**Operation 4:** Extraction of the tincture.  
(Union of the Salt and Sulfur through the Mercury).

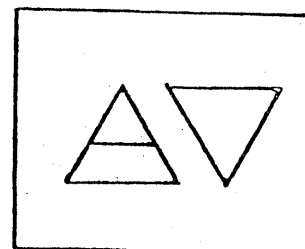

**Risks:** Contamination - temperature.

**Operation 5:** Imbibitions by the Mercury.  
(Sulfur and Salt are united by the Mercury,  
the Stone is complete)

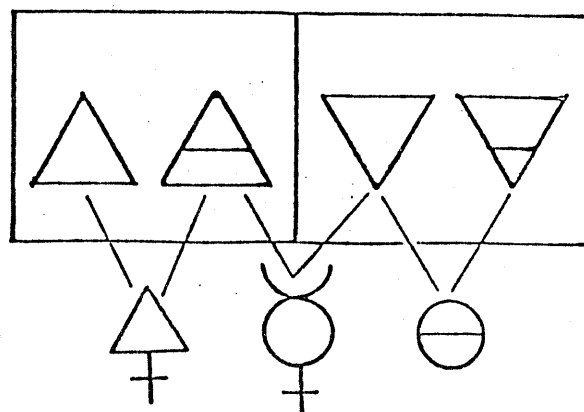
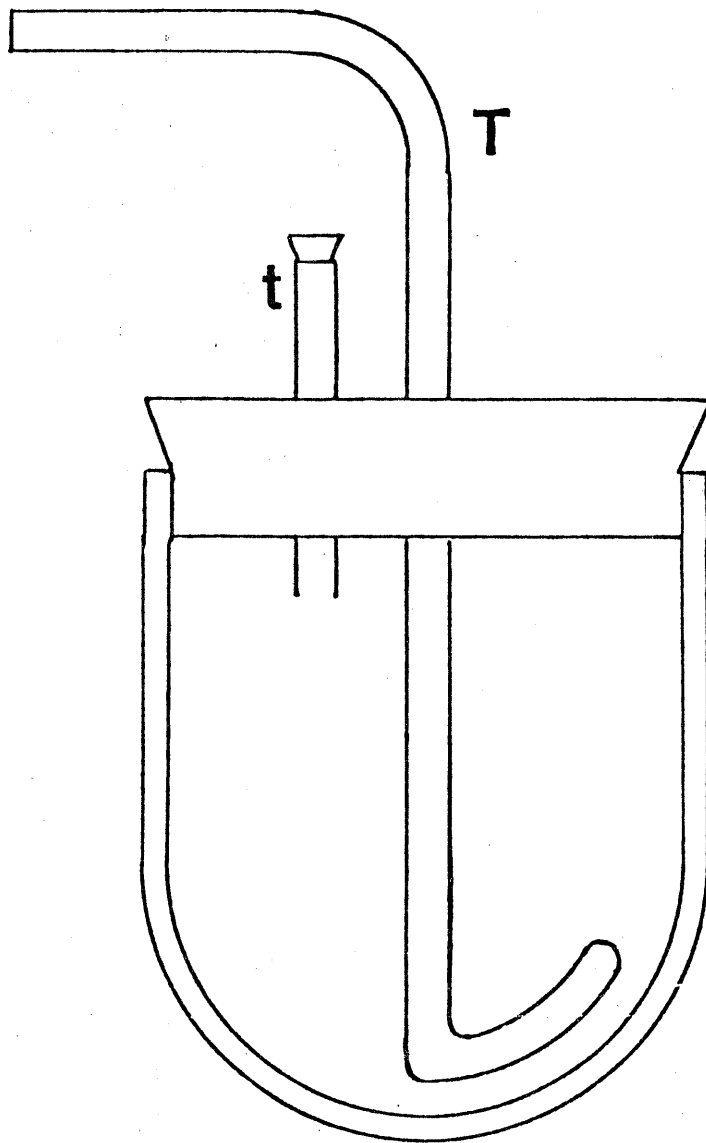

Figure # 4  
C.74.0290

### ANTI-CONTAMINATION DEVICE

T = tube for the mixing of the salt

t = tube for the imbibition





THE PHILOSOPHERS OF NATURE

Copyright © 1989 by LPN-USA

Lesson 75 - MINERAL - page 1

C.75.0390

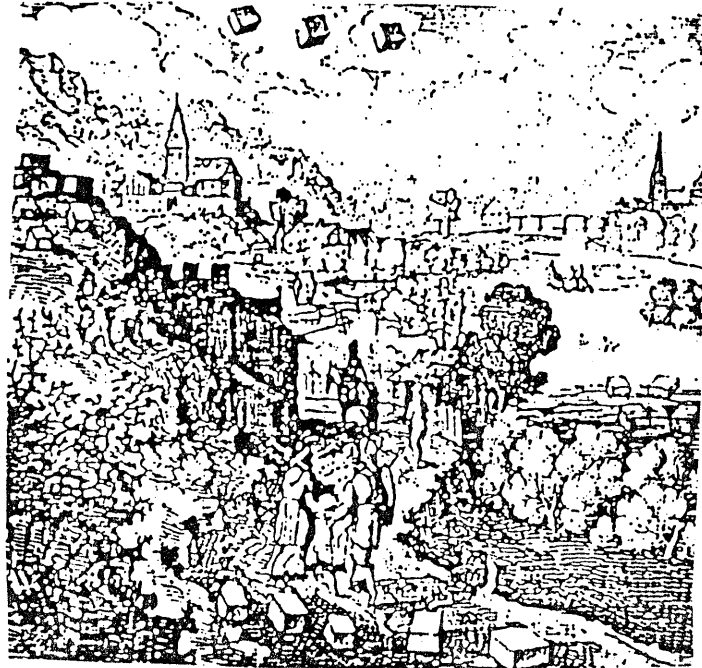

In the sky the three metals initiated in the form of cubic stones

Dear Friend,

Three apparatuses must be built as they are necessary for our new operations.

The first is an oven that should allow for the following operations possible:

- 1- Separating the stibnite from its gangue;
- 2 - Reducing the stibnite into a regulus;
- 3 - The making of the martial regulus;
- 4 - The making of the lunar or venusian martial regulus.

The second apparatus should make the distillation of the mercury and of the amalgam possible.

The third is a watertight crushing device to reduce the regulus and the amalgam.

### BUILDING THE SO-CALLED LPN OVEN

General drawing: (see Figure # 1)

- The structure of the oven is made with a large and tall aluminum cooking pot of about 30 x 30 cm;

- The parts of the heating chamber are made of poured refractory cement. In all the operations to be conducted, the cement used must be capable of sustaining a temperature of 1100 C. To use this cement and pour it, you must add 10 to 15 % more water than the recommended quantity;

- The insulation is insured with vermiculite (V);

- The heating element is a soldering rod using butane gas, 500 g/h type although a 370 g/h type could be enough.

The two main features insuring a good heat output of the oven are first a thermic insulation with vermiculite, and secondly, the fact that the flame arrives at a tangent. It then rises in a spiral insuring an even heating of the crucible which then can recover a maximum of the calorific power. This even heating insures a longer life to the crucible. When the oven is properly regulated, the flame swirls above the chimney.

The pour of the vertical muffle (Figure # 2)

The size of the muffle is as follows:

- Inner diameter about 100-110 mm;

- Height 200 mm;
- Thickness about 20 mm.

The pour of the cement occurs between the 2 (D) tubes. To prevent it from adhering to the sides, these have been covered previously with an adhesive substance (the kind used for any kind of packaging) which insures in addition, a good appearance to the piece.

The tubes are split because you have attached two blades of a hacksaw on the same structure. These side cracks are obturated by a wooden rod that is taken out during unmolding, making the latter easier. To insure that the tubes are centered a circle of plywood is placed at their basis and four blocks at the top.

During the pour shake the mold so that the air bubbles are driven out and as to obtain a well-formed piece. In our case, we glue the central circle on a small piece of wood which makes shaking by rotation and by rapid vertical shocks easier. It is good to plan disks on the top and bottom in the inner tube and tightening circles on the top and the bottom around the outer tube to prevent any distortions due to the pressure of the cement. After unmolding, the upper face is polished by grating the muffle with sand paper.

It is possible to plan for a hole (A) oriented as in B for the soldering rod to pass through. If the hole has not been done during the pour, you can make one with an adequate drill and finish it with a wooden grater.

#### Pour of the basis of the muffle (Figure # 2)

Prepare two plywood disks (E) whose outer diameter is the same as that of the vertical muffle. The central hole will have a 16 to 20 mm diameter identical to that of the stainless steel tube (you can use a steel curtain rod) which then can be used for draining.

The two disks are set up as in R and R'. The upper surface of R is covered with an adhesive substance. The central tube must go beyond the upper part by 25 to 30 cm. The top of the three threaded rods is furnished with a nut about 10 to 12 mm above the upper disk. The latter is circled by a tube of same diameter as the outer tube which has been used to pour the muffle.

The cement has been poured up to the dotted line, that is the height of the top of the central tube. After unmolding, the piece is polished with sand paper.

#### Pour of the chimney (Figure # 1)

The dimensions are not important. It is poured in two plastic tubes. The outer tube has the same diameter as the outer tube used for the pour of the vertical muffle. The inner plastic tube must form a cone as on the drawing but the outer conical appearance is not necessary.

The base of the chimney is grated with sand paper.

### Miscellaneous pours:

We must use the cement prepared in excess to pour the blocks and covers for the crucible. A nail taken in the mass of the covers will help to handle them (Figure # 3).

On the other hand, as antimony quickly attacks the muffle, it would be better to pour a second one in advance and, for the same reason, to plan for a few crucibles.

### Set-up of the oven (Figure # 1)

The cooking pot is attached to a rather heavy board with dimensions large enough for everything to be stable (40x40 cm). Fix it with threaded rods of 10 mm. The basis of the cooking pot should be 12 to 15 cm above the board.

One of the two disks of plywood used for the pour of the basis of the muffle is reused to mark the place to drill out the bottom of the cooking pot. The basis of the muffle is then installed with 3 threaded rods.

The underneath of the basis of the muffle must be 6 to 7 cm above the bottom of the cooking pot and the central tube must go beyond it by 1 to 2 cm. A small iron tape placed around the basis and going beyond it slightly, prevents the muffle from being off-center.

A tube made of thin sheet metal comes out on the side and is used as a guide for the soldering rod. There are refractory glues working at up to 12000 C which greatly facilitate the setting of the the injection tube of the flame into place.

This being done, fill in the cooking pot with vermiculite (V) which should reach a thickness of 6 to 7 cm in all areas in order to insure a good thermic insulation.

When the filling is over, place a plywood circle with adhesive substance on the vermiculite. Then place on top and around the outer muffle a thin cardboard coated with plastic and another one on top, against the inner part of the cooking pot. Then pour a circle of cement of a thickness of 2 cm. When it has hardened, take the cardboards out, and the cement and plywood circles. Add vermiculite so that the cement circle, once in place, arrives slightly past the muffle so that it prevents a possible lateral outlets for the flames at the basis of the chimney. Two holes and 2 parker screws immobilize the circle when moving the apparatus around.

### Safety measures to start it.

- 1 - Let the cement dry up naturally for a few days;
- 2- Place an electric lamp of 100 to 150 watts in the oven and leave it lit for an entire night;
- 3 - Perform one or two short heatings with gas for 5 to 6 mn. The oven is ready;
- 4 - For the operation of purification of the stibnite, you must have a steel tube that can go through the central tube.

### Set-up for the purification of stibnite:

The top part of the crucible should not be lower than 1 or 2 cm from the top of the muffle.

If a cement block is necessary to place the crucible, it will be poured around a tube identical to the draining tube.

The crucible will be drilled with a 5 to 6 mm hole. Always at its basis but on the outside, a small dip will be made of the same diameter of the appended tube which will be used to align the crucible, the block and the base so that there is no obstacle on the way of the stibnite which will then be able to flow freely.

If the alignment tube is obstructed, it is enough after it has cooled down to take it out and heat it with the soldering rod to have the stibnite flow again. This tube will be slightly smaller than the tube of the basis, for instance, diameter = 20 mm for the basis, and diameter = 16mm for the tube. It will be cracked at the basis by two saw lines so that it can form a small tape which by pressure will insure that it stays in place.

This tube gives two advantages:

- 1 - The block, crucible, basis are vertically aligned;
- 2 - In case of obstruction there is no problem for the oven.

### SEPARATION OF THE STIBNITE FROM ITS GANGUE

When the set-up is complete, fill the crucible with small pieces of stibnite (size of a hazelnut). Put the cover on the crucible. Under the hole of the draining tube, place a small dish containing distilled water on a height of 1 or 2 cm.

The soldering rod is lit outside the oven and at reduced temperature. Place it in the oven then regulate it up to its maximum heat. About ten minutes later the melted stibnite falls into the water. The gangue remains in the crucible.

We obtain thus a stibnite which when it is transformed into regulus won't give parasitic scoriæ.

**Note:** The hot crucible can be manipulated with the kind of pliers used to take hot dishes out of the oven. Be careful the metal of the pliers tends to melt easily, so operate quickly so that the pliers does not have time to heat up.

#### Safety measures:

##### a) Safety

- Definitely have asbestos gloves, and goggles;



- Never breathe the vapors above the oven.

b) Practical

Make sure you have the following material handy for the works suggested:

- Stibnite or regulus, but stibnite is better;
- Mercury: the distillation apparatus allows you to buy a second hand mercury less expensive;
- Silver metal: it is rather expensive but the text enclosed enables you to get some more through recycling. On the other hand, although we need an important quantity of it, a greater part is recouped after each series of operations.

\* \* \* \* \*  
\* \* \*  
\*

### PREPARING SILVER FOR PHILALETHERS' AMALGAMS

Find silver objects: old jewelry, coins, cutlery ..., the regular market nitric acid and an electrical shaker.

Be careful: work outside or under a fume hood with gloves and goggles for each operation.

The most practical shaker for these operations is essentially made by a pyrex test tube or any other container with a height of 30 to 40 cm and 70 to 150 mm diameter, provided it is not made of metal.

This test tube is set to rotate at a speed lower than 1 turn per second: 1 turn in 2 to 3 seconds is appropriate. The axle of the container makes an angle of 45° with the vertical.

We fill the test tube with nitric acid from 1/3 to 1/2 of its height. The silver objects are loaded a small piece at a time. The reaction begins slowly and is accompanied by a heating of the liquid. If too much metal has been loaded, the temperature rises; if it goes beyond 84 C, the acid boils, there is a release of red and very toxic vapors and a risk of overpouring. The end of the reaction is observed through the fact that no more bubbles form in the liquid.

The acid is not entirely used because the reaction ceases at a certain degree of its weakening.

During the reaction the gas which is released is hydrogen, an inflammable gas which should be driven away.

The liquid is filtered and we have then a solution which contains:

- a) water;

- b) nitric acid;
- c) silver nitrate;
- d) copper nitrate;

If the alloy of the jewels contains zinc, the latter is eliminated during filtering in the form of a greyish yellowish mud.

To avoid the release of toxic red vapors and to recoup the acid not used up, perform a first a "traditional" distillation. However, the receiving flask is charged before distillation with a bit of demineralized water and the outlet occurs through a bubbler loaded with a base for instance ammonia which will turn into ammonium nitrate, dew salt in alchemy.

While the acid passes over, the temperature of the vapors is 84 C; as soon as the vapors go up to 100 C, there no longer is any acid, only water goes over. We must then withdraw the liquid from the distillation apparatus and start a slow evaporation.

When the volume of liquid has been reduced by 1/2 or 1/3, you must pour it in a cupella preferably of a half spheric form, which limits breakage risks.

Let it then cool down to observe if in the cold the liquid solidifies or becomes pasty. We enter the critical phase of the operations.

We now have a mixture of copper nitrate and silver nitrate. We must know that the copper nitrate melts at 112 C and decomposes at 300 and that the silver nitrate melts at 212 C and decomposes at 444 C.

Be careful, the decomposition of one or the other of the nitrates releases toxic vapors of nitric acid.

The practical solution consists in heating the salts in a porcelain thimble with a gas heating that can be easily regulated (a metallic canvas separates the flame from the cupella).

Do not stop shaking the mixture to insure an even spread of the heat. Operate with a glass rod or better even with a graduated thermometer ( 360 to 400 C). Thus, we make the temperature of the mixture even and we can watch it constantly.

Probably because of the presence of silver nitrate, the decomposition of the copper nitrate starts around 240 C. This decomposition is observed by the green color which progressively disappears to be replaced by the black color of the copper oxide.

When all the green has disappeared and there no longer are any red vapors, let it cool down and we obtain a white salt (silver nitrate) mixed with the black copper oxide.

The silver nitrate is dissolved in demineralized water. Filter to eliminate the insoluble copper oxide.

A coagulation without boiling gives silver nitrate. The latter is kept away from light otherwise it decomposes.

It is not useful to reduce it to the state of metal for its use in Philalethes' amalgam.

**Note:** The silver nitrate solid or in solution causes black spots which only disappear very slowly, therefore do not forget the gloves. Anyway, in case of an accident: wash your skin with a solution of potassium iodide, the spot becomes yellow; then eliminate it by rinsing it with soda hyposulfite (photographic fixating agent).

\* \* \*

\*

### Dry way and humid way

Philalethes, himself, contests this possibility of the two ways in his work "Entrance to the Closed Palace of the King".

We have said, in the present lesson, that the energy transfers (Fire) could not happen in the liquid state.

In ancient times, when the philosophers had no yet discovered strong acids: hydrochloric acid, nitric and sulfuric acids, the only solution to dissolve metals was mercury (a dry water not wetting the hands), therefore the dry way.

The discovery of strong acids enabled the "aqueous" dissolution of metals, or the humid way. The top product of this way is aqua regia, capable of dissolving gold, the king of metals.

In this sense, the process of the amalgams of Philalethes which does not use any acid in the essential part of its process, belongs to the category of the dry ways.

Ora et Labora!

### THE PHILOSOPHERS OF NATURE

#### Enclosed figures:

- I - General Drawing of the "LPN" Oven
- II - Molds - Parts of the Muffle
- III - Set-up For the Purification of the Stibnite

Figure # 1  
C.75.0390.

### GENERAL DRAWING OF THE "LPN" OVEN

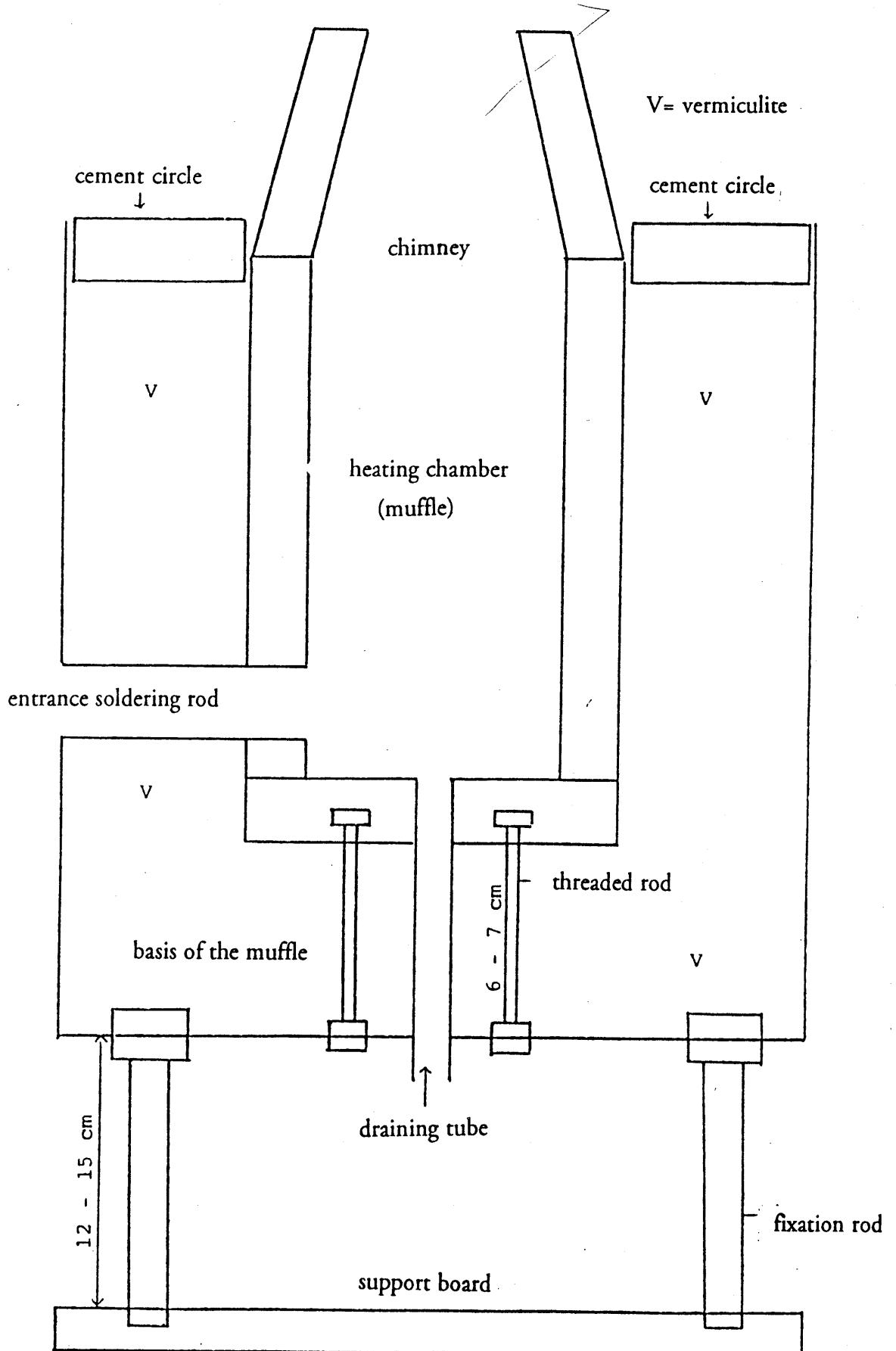

### MOLDS - PARTS OF THE MUFFLE

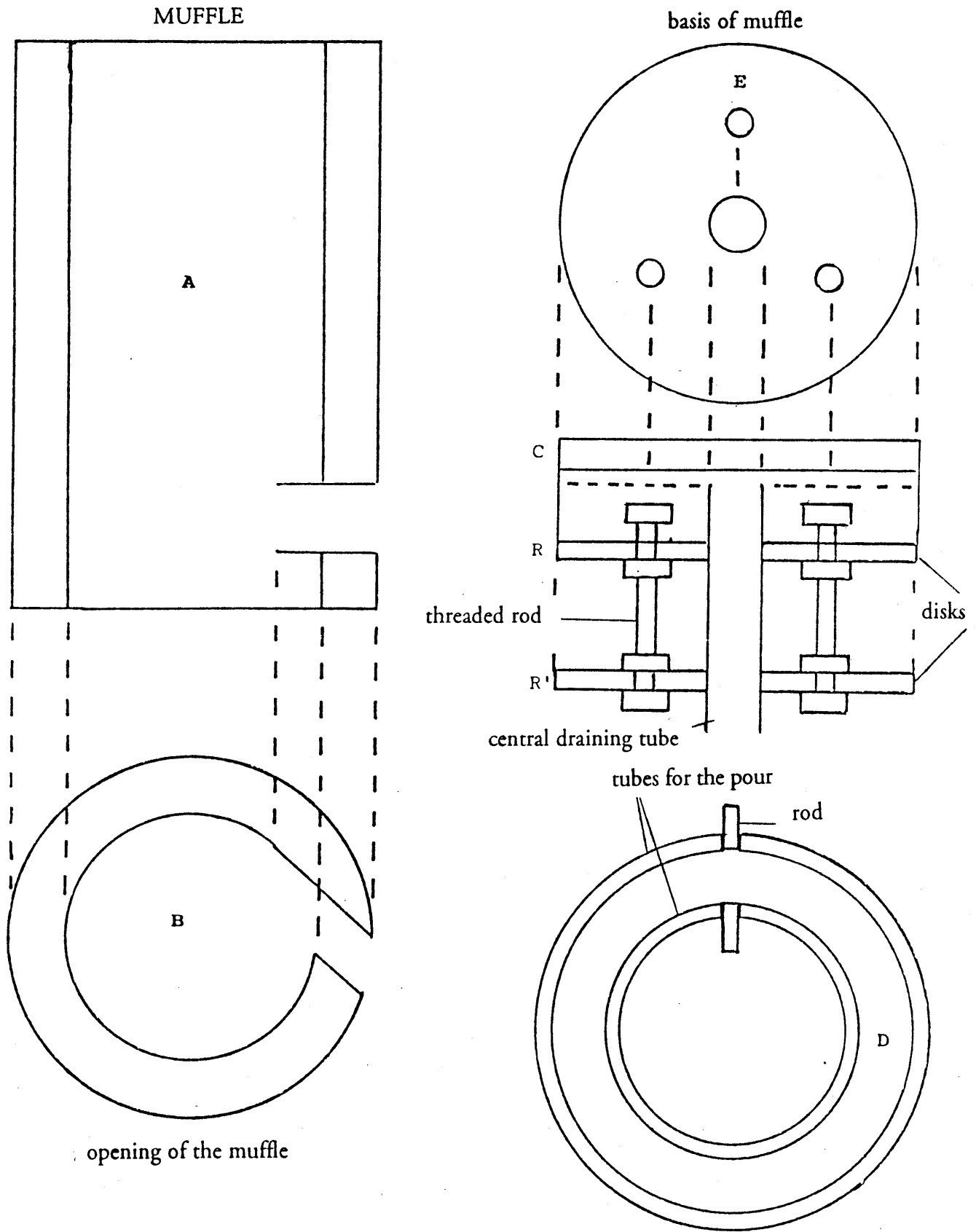
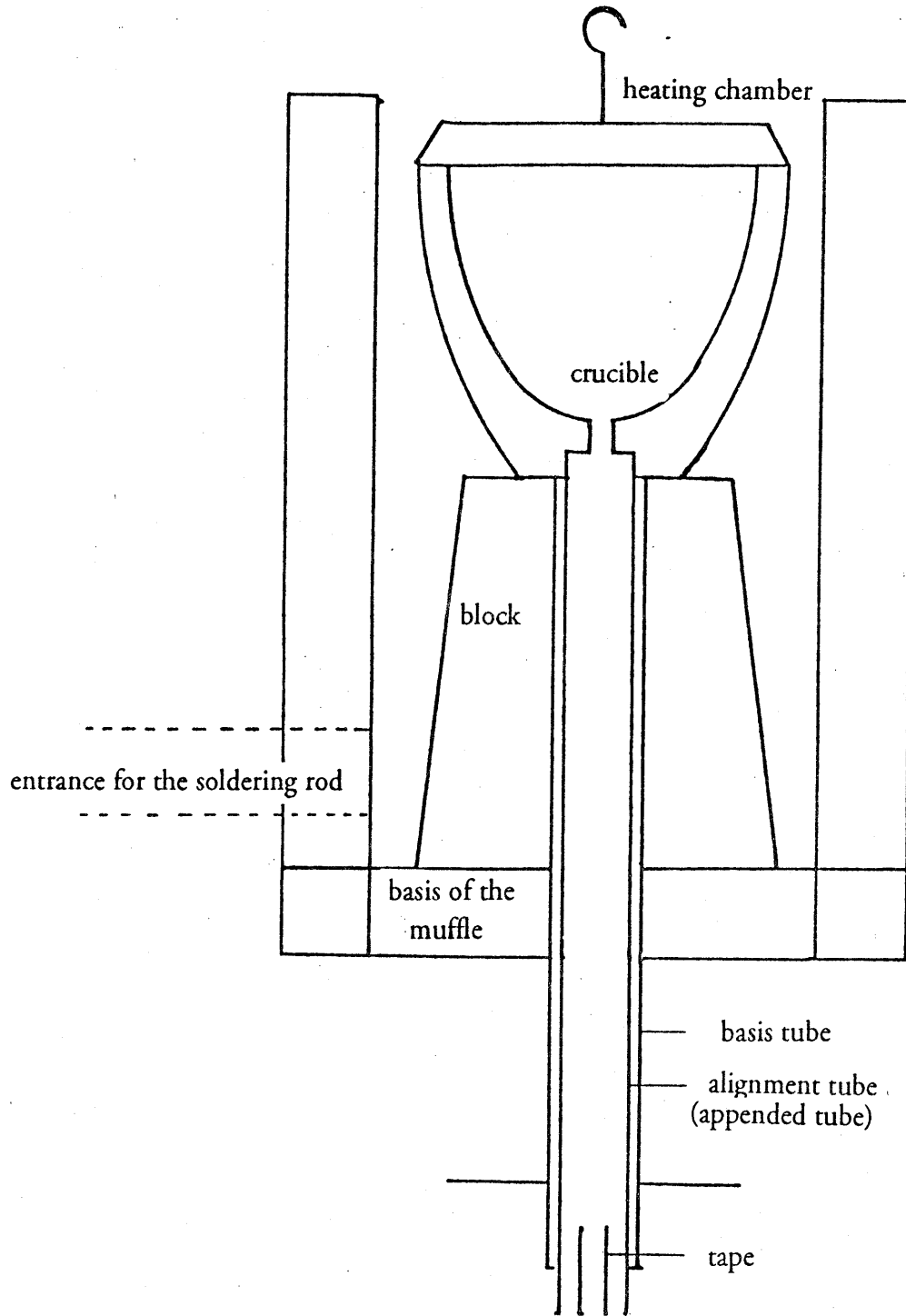

Figure # 3  
C.75.0390

SET-UP FOR THE PURIFICATION OF THE STIBNITE





# THE PHILOSOPHERS OF NATURE

Copyright © 1989 by LPN-USA

Lesson 76 - MINERAL - page 1

C.76.0490



Aries (the ram) - iron - and the wolf - antimony - provide the elements necessary to feed of the Work.



Dear Friend,

The martial regulus can be obtained either from the regular regulus or from stibnite. If we take stibnite as the starting point, the operation previously described - the separation from the gangue - is not absolutely mandatory but it has the advantage of reducing the problem of scoriæ in crucibles quite a bit. We should remember that the separation is not complete through this process. But if we consider separation through digestion i.e. the stibnite is soaked into a solution of soda or potash, there is a transfer of energy and there is a risk of losing the quality as shown through the previous theoretical explanations.

### REDUCTION OF THE STIBNITE INTO REGULUS

The reduction of the stibnite into a regulus happens if we add something that is going to absorb the sulfur of the stibnite, the minerals added will be then an absorbent of the sulfur and a fluxing agent to facilitate the fusion in the crucible. The proportions of the mixture vary according to the authors and to the quality of the ore. As far as we are concerned, it seems correct to have as a weight of potassium nitrate half that of potassium carbonate and a weight of the blend equal to the weight of stibnite. The whole is reduced to fine powder and is dried out, otherwise there is a risk of overflowing in the crucible.

For this operation, first take out the "chimney" of the oven and install a high crucible. It is good to plan for a quantity of the mixture equivalent to 2 or 3 times the volume of the crucible. This powdery blend is poured into the crucible heated to the red, one teaspoon at a time. Immediately after each loading, put the cover on it and wait until the matter in the crucible becomes "quiet" again. The operation ceases when the outer rejection of powder becomes too important.

A steel blade is needed in order to grate the scoriæ out after the pour of the metal, because they are not very liquid and tend to solidify rather quickly. Several successive fusions can be necessary in order to eliminate the sulfur from the stibnite.

The ingot mold for the pour must be strongly heated in order to obtain a slow solidification which allows, on the one hand, the scoriæ to raise to the surface and on the other a better crystallization.

### THE MAKING OF THE MARTIAL REGULUS

The crucible is loaded with the regulus issued from the stibnite. Put into it several small nails, whose weight will be around 1/10 of that of the stibnite.

Be careful, the idea is not to make an antimony-iron alloy but a solution of iron in the antimony. This will be valuable then for copper and for silver.

To obtain this result, the temperature must be higher than the temperature of fusion of the regulus but lower than that of the metal you add.

The added metal is dissolved like salt in water and, identically, the dissolution ceases when the regulus is saturated with the metal. So, for iron, use nails and not powder because the nails that have not been dissolved can be easily separated from the regulus and the fact that some are still present after the pour indicates and proves that the regulus is saturated. As the dissolution of the iron is slow, the regulus must be maintained in fusion at least for half an hour.

For the entire duration of the operation, the cover of the crucible must remain in place, which prevent a great deal of loss.

The regulus obtained must be re-molten several times with a load of potassium nitrate which eliminates, through oxidation, the impurities. The operation ceases when there are no more scoriæ by the pour.

The iron has a double function: first to help the residual absorption of the iron; and second, to bring an alchemical element of a magnetic nature to the regulus.

Several authors mention 4 to 5% for the weight of iron dissolved. It is also our opinion.

The crystallization gives an idea of the level of purity.

## DISTILLATION OF THE MERCURY (Figure # 1)

Mercury boils at a temperature of 360 C, a temperature where pyrex glass becomes soft. The flask must then be maintained in shape by a sand-bath or you must use a quartz flask.

The speed of circulation of the mercury vapours is very high. Therefore, condensing through the glass is impossible. Bubbling in the water of the vapor is the only solution for their condensation.

The distillation forces the vapors of mercury to drive the air away into the flask. When the heat stops, a vacuum is produced. A device preventing the water from coming into contact with the mercury must be planned. Water on mercury at around 300 C means explosion.

The device must be completely airtight because vapors of mercury are very toxic.

### Use of the instrument

Impure mercuries seriously mess up the flask, so it is best to have one flask put aside for the first distillations, a second one for the other distillations and a third one reserved only for the distillation of the amalgams.

The cleaning of the flasks is often possible only with aqua regia. Be careful, the resulting products are highly toxic.

## DISTILLATION OF THE AMALGAM

### 1st solution - a very difficult operation - (see Figure # 1)

We shall see later the making of the amalgam but given the similarity between the distillation of the amalgam and that of the mercury, it seems a good opportunity to talk about this subject now.

The amalgam before its solidification is reduced into small balls whose diameter should not go beyond the third even the half of the inner diameter of the neck of the flask.

The operation consists in drying the amalgam out of the mercury it contains.

There should be no fusion of the regulus otherwise it forms an alloy with the quartz of the flask and it is lost.

To check the heat and stabilize the temperature, it is good to have a thermic screen on the top of the flask and on the neck in the part between the flask and the outlet tube. Because of this, the distillation will be very slow and the temperature always maintained at the possible minimum. It would not be prudent that one of the point of the flask went beyond 400-420 C.

The ideal solution for the distillation of the amalgam, and also valid for the mercury, is to build a small thermal mantle kept at a 20 C temperature by a thermo-electric and thermo-electronic couple; which implies that you already have some electronic background.

The distillation of the amalgam is a key point in the operations because it provides the animated mercury, so-called "Sophic mercury".

The other possibility, which would also prevent having to go through this operation consists in attempting the awakening of the secret fire directly in the amalgam by a long digestion.

### Second solution (See Figure # 2):

You must have a quartz test tube about 50 cm long with a diameter of 8 to 10 cm.

It is also possible to operate with a borosilicated glass tube but in this case the length needed will be around one meter; and the part to be heated is to be heated by a sand bath.

The amalgam will be placed at the bottom of the very slightly slanted test tube, the open side positioned as low as possible. This opening will be shut by a stopper made of polyurethane or a similar matter. An 8 mm tube will go through it and will dive into a narrow test tube filled about 25 to 30 mm high with distilled water.

In the heated part where the amalgam is located, the mercury will evaporate. Given the length of the tube and the bad thermic conduction of the glass or quartz, the opposite part is going to stay relatively cold, so that the mercury will be condensed in that area and because of the slant

of the tube it will be concentrated close to the stopper. A slight part of the vapors will reach the exhaust tube.

When the heat stops we must make sure that the water of the safety test tube does not move into the tube; in any case, the minimal quantity of water used makes it impossible for it to reach the higher areas of the device.

The tube being narrow and straight and with a big aperture the extraction of the residues of the amalgam does not pose any problem.

**Note:** If you use borosilicated glass a mechanical support for the tube is essential.

## THIRD TREATISE OF ANTIMONY

(Quotes from the works of Alexander Von Suchten (Franckfort 1680)  
by S. BACSTROM (1797)

**Note 1:** Given what we just said, the enclosed text should already give you a more specific idea of the solution of the amalgams. In this system, the stibnite is directly transformed into martial regulus, without going through the phase of the simple regulus.

### A Von Suchten's process of preparing the martial stellatus regulus.

You must cleanse your mercury with a sulfur proceeding from mercury and not from salts. This metallic sulfur in the antimonial mercury is reduced into mercurius vive, and at last this mercurius vive becomes pure gold.

The metallic sulfur, which must purified the antimony (mercury in Dubuis' text) is to be found in iron only, and no where else, and this purification is performed in the following manner.

### Martial Stellated regulus of antimony

Take good Iron 4 ounces, I take small iron nails, put them into a strong roomy crucible, which place in a Wind furnace, raise a good heat, and let it stand until you perceive the nails become soft and pappy, the crucible being of White heat, then project into the crucible 8 ounces of good pulverised antimony, well heated, raise your Fire to a great heat, so that the iron may melt well in the antimony;

Then throw into the crucible with an iron spoon having a long handle a good handful of nitre, previously well heated and thoroughly dried, and it will fulminate, therefore your crucible must be large, that the matter may not boil over.

Then raise a great heat, that it may flow thin, and pour it out as hot as possible into your heated and oiled iron Cone, and let it cool gradually.

When it is cold give the mass a blow with a hammer, and the regulus will drop from the black-greenish Scoria. This Scoria resembles a Marcasit; you may preserve them, until you learn their nature, for in them is a mystery whereof I shall not speak at present.

(The mystery is, that THE FIRST SCORIA contains the sulfur of iron and of antimony, whilst the regulus contains both mercuries).

**Note 2:** In this first part it is not mentioned that the regulus must be introduced into the crucible.

Put the regulus into a New crucible, let it flow, as soon as it is melted, add 1 1/2 ounces of fresh powdered and heated antimony, and let them well flow together, then project as before a handful of very dry heated niter, raise your heat, that they may flow and boil strongly together.

Whilst intensely hot, flowing as thin as water, pour it into your heated oiled Cone, and let it cool gradually.

Beat the regulus from the Scoria. This regulus is finer and purer than the first. The Scoria throw away, because they are good for nothing.

**Note 3:** The idea here is to bring the sulfur of antimony to the martial regulus; fresh antimony is stibnite separated from its gangue.

Let this regulus melt in a new crucible, and as soon as it flows clear, project a spoonful of heated niter, you must cause the niter to flow on the regulus like an oil, which is effected by raising a strong heat, otherwise the niter will be coagulated and remains hard on the surface.

Raise your heat, and pour the mass out into your heated oiled Cone, and let it cool.

This regulus is still finer and handsomer, purer and more metallic than the former.

These scoria are good for nothing.

The fourth time let this regulus flow in a new clean crucible, and as soon as it melts like silver, project again a small Ladle full of heated niter, and let them well boil together, about twenty minutes, then pour it into the heated Cone, whilst it flows like oil, raising you heat to a great degree, the moment you intend to take it out.

Let it cool gradually in the Cone; when cold, beat the regulus from the Scoria; if the Scoria are of a golden colour, you have worked rightly.

**Note 4:** The successive pours allow to the scoria to raise to the surface. Iron and silver dissolve only very slowly in antimony. The dissolution time is about 1 hour to 1 hour and a half.

Your regulus will be like fine silver, and will have a fine Star on the Superficies and within.

This regulus will weigh nearly 4 ounces, if you have worked right.

In this process the antimony extracts the Mercurial Soul out of the iron and reduces it into a dry mercury.

This mercury is nothing else but fire, and operates like fire, and digests the crude mercury in the antimony, separating the minera (ore) from the metal.

You must also observe, that the mercury of iron is in this purified antimony, hidden in the silver colour of the antimonial mercury.

The silver colour you see in this regulus, is not from the sulfur, but from the mercury, wherein the mercury of iron lays concealed, WHICH IS NOTHING ELSE BUT Gold.

This mercury of iron is in the antimonial mercury like a spirit or an air (a Fire rather) it remains living in the antimonial mercury, until it is corporified and SEPARATES ITSELF from the mercury of antimony (Coel: Philosoph: Msc.)

If you can comprehend what that fire is, which thus purifies the antimony, you will also understand what that Fire is, which purified and digests our magical antimony, that is: you will know what the philosophical gold is, which I call AURUM POTABILE, which separates itself at the End from the mercury of the philosophical antimony, in the same manner as the pure gold is separated from the mercury of antimony.

(I think COELUM PHILOSOPH: explains all this)

If you wish now to revive this antimonial mercury into living mercury, it must be done by mercury, but without a medium it cannot be done; because we see that the regulus cannot be mixed with common mercury, on account of the sulfur contained in the regulus.

As this sulfur is not metallic, he has no Sympathy with common mercury, and therefore hinders the mixture.

Therefore a medium of union must be found out between the common and antimonial mercury, and in this medium there must be a power, which is not in vulgar mercury; as in vulgar mercury there is no Specific power. There are but two sorts of mercuries, the common and the Sophic mercury.

Now as the separating power is a mercurial Specific power, we must find out in what mercury that power can be found, and Experience has taught, that it is in no other mercury but IN THAT OF SILVER.

### Process

Therefore take fine silver one ounce and of your pure regulus 1/2 ounce, let the silver glow well in a New crucible, then add the regulus, and they will flow soon and melt in the crucible, and look like common mercury, pour it into your Cone, and you will obtain a Lead coloured mass.

This mass reduce into powder, it is easily done; Then take pure common mercury 4 or 5 ounces pour it into a glass phial, then pour the powdered Lunar regulus into the phial to the mercury (Let it stand a day and a night in B.M> so the powder will go into the mercury:) shake this phial well, in order to mix the substances, and when you see the powder well mixed with the running mercury, pour it out and amalgamate it well on a warm stone, and you will have a true amalgam.

**Note 5:** We put the lunar martial regulus and the tridistilled mercury in the crushing device described in Mineral Lesson # 77. The weight of the silver can be much lighter, as this only acts on the time of formation of the amalgam.

### Purification of the amalgam

Put this amalgam into a wooden dish, pour water upon it, and grind it with a wooden pestle, and the water will become black, pour the black water off.

**Note 6:** Dish and pestle should be made of porcelain.

Pour fresh water upon it, grind again until this water is become black, then pour it off, and continue washing the amalgam in this manner, until it is like fine silver, and the water remains clear upon it.

The black earth washed from the amalgam settles in the water, keep it, and pour the water off gently.

Put the amalgam into a glass phial, let it stand overnight in digestion in a bath, then pour it out, and wash it as before, and it will yield more black earth, continue these washings until you can get no more blackness from the amalgam.

You may also grind the amalgam with pure white salt, and the blackness will part from it the sooner.

When you can obtain no more blackness from the amalgam, it will be pure and beautiful like silver.

Observe the more blackness the amalgam yields, the more regulus is reduced into antimonial mercury.

When no more blackness comes forth by the Washing, then put your bright amalgam into a glass retort, and distil the running mercury from the amalgam, i.e. from the silver.

If the washing has been well performed, your niter will remain in the retort like a beautiful white lime. But if the silver is of a lead colour, it is a sign, that it contains yet some antimony.

Therefore such a lead coloured silver lime must be washed further, until no blackness remains at all.

The Receiver must be full of cold water, before you distil the mercury over, and you will obtain a most beautiful and pure mercury, which is of a 3 fold quantity, viz: mercury vulgi, mercury antimonii and mercury of iron.

But note that the mercury of iron does not transmute the two others into its own nature, because the mercury of iron is not radically mixed with the two others, and therefore is separated again from them afterwards, as you will hear.

Therefore this mercury ought not to be called mercury of iron, but mercury of antimony, because antimony is full of mercury. The mercury of iron which lays concealed in this our mercury, is Volatile gold, and that you may see and believe it, take a small quantity of your bright washed amalgam, before you distil the mercury from it, and cause the mercury to evaporate from the silver gently, and this gold volatile ex iron that is mercury of iron will remain with the silver and tinges your silver into a most beautiful Colour of gold, but as this gold is volatile, it does not remain with the silver in the melting, but forsakes it and flies off.

The mercury you have distilled from the amalgam, i.e. from the silver, by retort, penetrates the metals and separates the Elements of the metals, that is it divides the mercury from the sulfur, which common mercury can not do, except it be animated by mercury of iron, and transformed into its nature.



(The process agrees with those in my other MSS.. Only fresh regulus should be melted with the remaining lime of silver which should be amalgamated with the mercury formerly distilled. This should be repeated 7 or 10 times).

Thus far Von Suchten concerning the martial stellated regulus.

The same author, p. 234 writes thus: antimony is an Ore, wherein lays a metal, which is mercury. This mercury the physical artist must extract out of the antimony. The separation must be made in such a manner, that the Metallic Splendour which is conspicuous in antimony, may not be burnt and lost, but must be exalted and extracted;

This metallic Splendor appears after the separation of the external burning sulfur in the Scorixæ, and is then no longer common antimony, but THE MERCURY OF THE PHILOSOPHERS; this can be melted and cast like any other metal, and flows in the crucible like pure silver. By this character you may know that it is no longer common antimony but mercury; although antimony is not mercury yet it contains mercury in its center.

**Respecting the mercury of copper introduced into the mercury of antimony;  
the same author writes as follows:**

**(See English edition of his Secrets of antimony, London, 1670, p. 83)**

I shall now show you how you may obtain, by means of the mercury of antimony (copper in LPN-France material), the gold which animates your mercury of antimony. This gold is nothing else than the mercurial spirit which is in iron as the soul in man; but as this gold is no more corporeal as it was before in iron, but through the mercurial spirit of antimony has become a spirit it can no more be made corporeal but only through the spirit of the salt of copper. This spirit is not the mercury of antimony; nor it is her sulfur: it is a middle betwixt both. When this middle cometh forth of copper her parts fall in pieces, that is the mercury and sulfur. The mercury of copper abideth in the mercury of antimony - the sulfur must be washed from it, and is a sulphureous grey earth like ashes.

Take two lib. of the best Hungarian vitriol; dissolve it in common water; set it in a strong pot over the fire and cast half a handful of small pieces of iron therein and let them seeth therein for 10 minutes; then pour off the water, and put to the iron the mercury which you have distilled from silver (that is the antimonial mercury which has had its proper number of Eagles). The antimony which the iron has reduced from vitriol will thus amalgamate itself with the mercury. Wash the amalgam clean that all the pieces of iron may come from it. When pure and clean let it dry and then put it into a glass phial, set it in B.M. for 8 nights and days and it will become of a dark grey colour, then pour it out and wash it clean in the usual manner in a wooden dish. (Note: porcelain).

The powder which you wash from the amalgam put apart: then put the amalgam again in B.M. for 8 days and nights, and wash it as before. Do this a third time. But if you would resolve all the copper into mercury and sulfur you must repeat the work till the amalgam be converted into pure mercurius vive, which will not be quickly done.

When you have had this amalgam thrice in B.M. and thrice washed it then distil the mercurius vive from the copper as you did before from the silver. It is now neither mercury vulgar nor mercury of iron, but through the mercury of copper has been fermented and transmuted into the mercury of copper.

This mercury of copper is a wonderful mercury, as every one can prove who shall use it in chemical operations. The precipitate also made from this mercury is exceeding bright and wonderful in the eyes of Alchemists, but bright as it is it is a deadly poison in physic: keep yourself from it, and let not his fine appearance deceive you.

In this mercury of copper the gold out of iron lays yet hidden: it wanteth the frigidity of the moon by which it shall receive the perpetual and first coagulation of gold; and the process of coagulation is as follows:

Take of fine silver in which there is no gold one part of this mercury of copper 4 parts; make an amalgam thereof, and that it may be the easier accomplished dissolve the silver in aqua fortis and precipitate it with copper in the usual manner. The precipitate will fall to the bottom in the form of a fine bright powder, which may easily, by grinding, be amalgamated with the mercury of copper. Wash this amalgam till it be clean and bright: put it into a phial and let it stand 24 hours in B.M. boiling - then will it be as black as a coal: take it out, grind it on a stone, and wash it clean.

The black powder which you thus separate is the soul of iron, which is thus drawn from the spirit of antimony and by this work is coagulated into gold; but with this gold there are as yet faeces of sulfur which have been drawn from the mercury of copper by this coagulation; for the mercury of copper is always green on the superficies. This greenness is coagulated with the gold (ex Martis) and being, with it, separated from the mercurius vive, the gold must be reduced into a body and so is the spirit of iron found. Thus you see what the spirit of iron is, and what comes from him. He that wishes may then try how much mercury is in 1 lbs. of iron; for so much gold shall he find herein and no more: and he will find the cost more than the gold is worth.

### Finis

(The cost will certainly be more than the profit if the powder be reduced into a body; but the powder is in fact Sophic gold and with Sophic mercury may by proper treatment be digested into a tinging medicine. See COELUM PHILOSOPHORUM. PHILOPE PONIA. MSS. without name, etc, etc, etc.)

Note 7: The text is intentionally obscure. Remember that:

- The lunar martial regulus gives the philosophical mercury for the white stage of the work;
- The lunar martial venusian regulus gives the philosophical mercury for the red stage.

Ora et Labora!

THE PHILOSOPHERS OF NATURE

Enclosed plates:

- I - Distillation of the mercury
- II - Distillation of the amalgam

Figure # 1  
C.76.0490

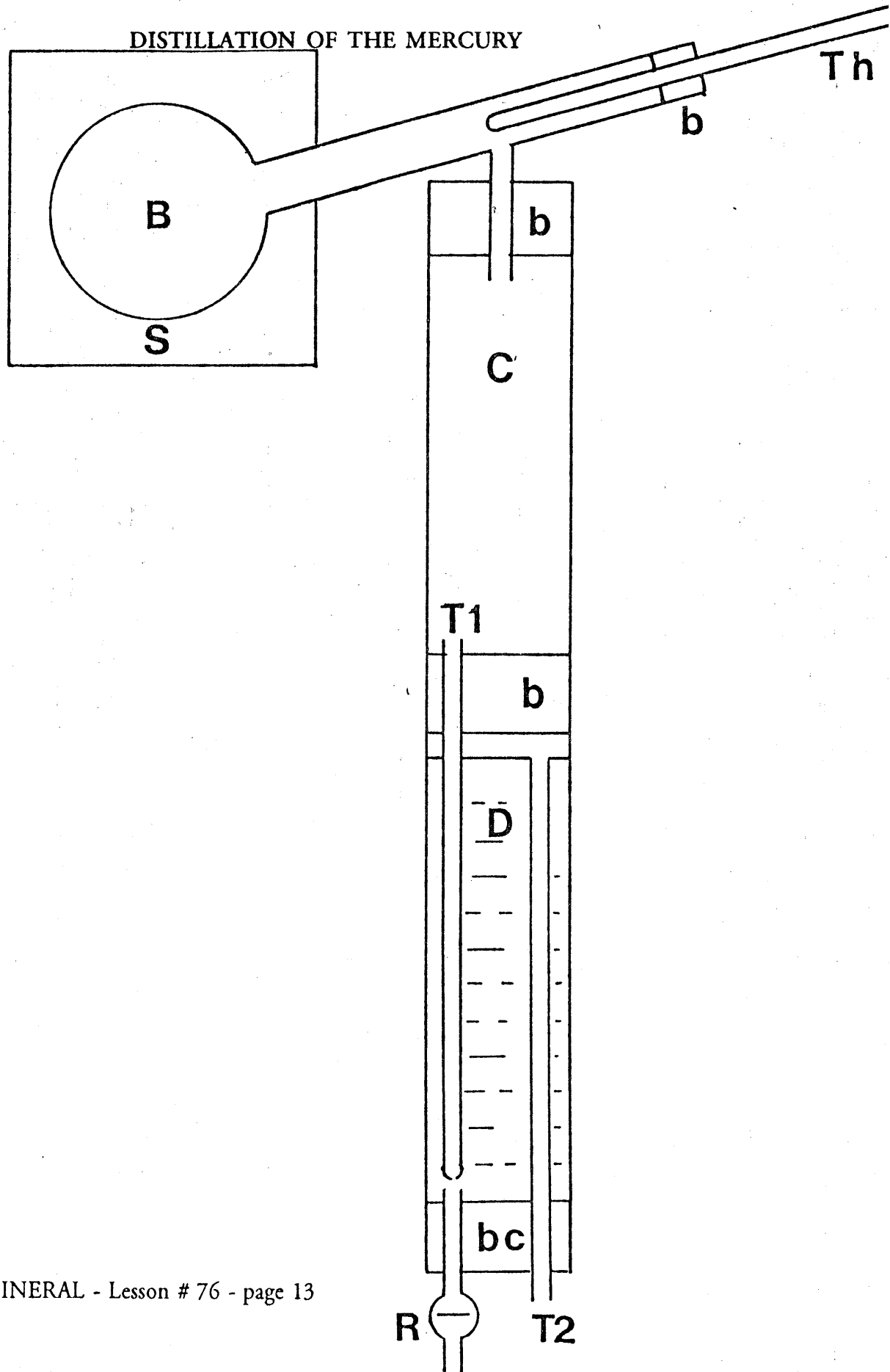
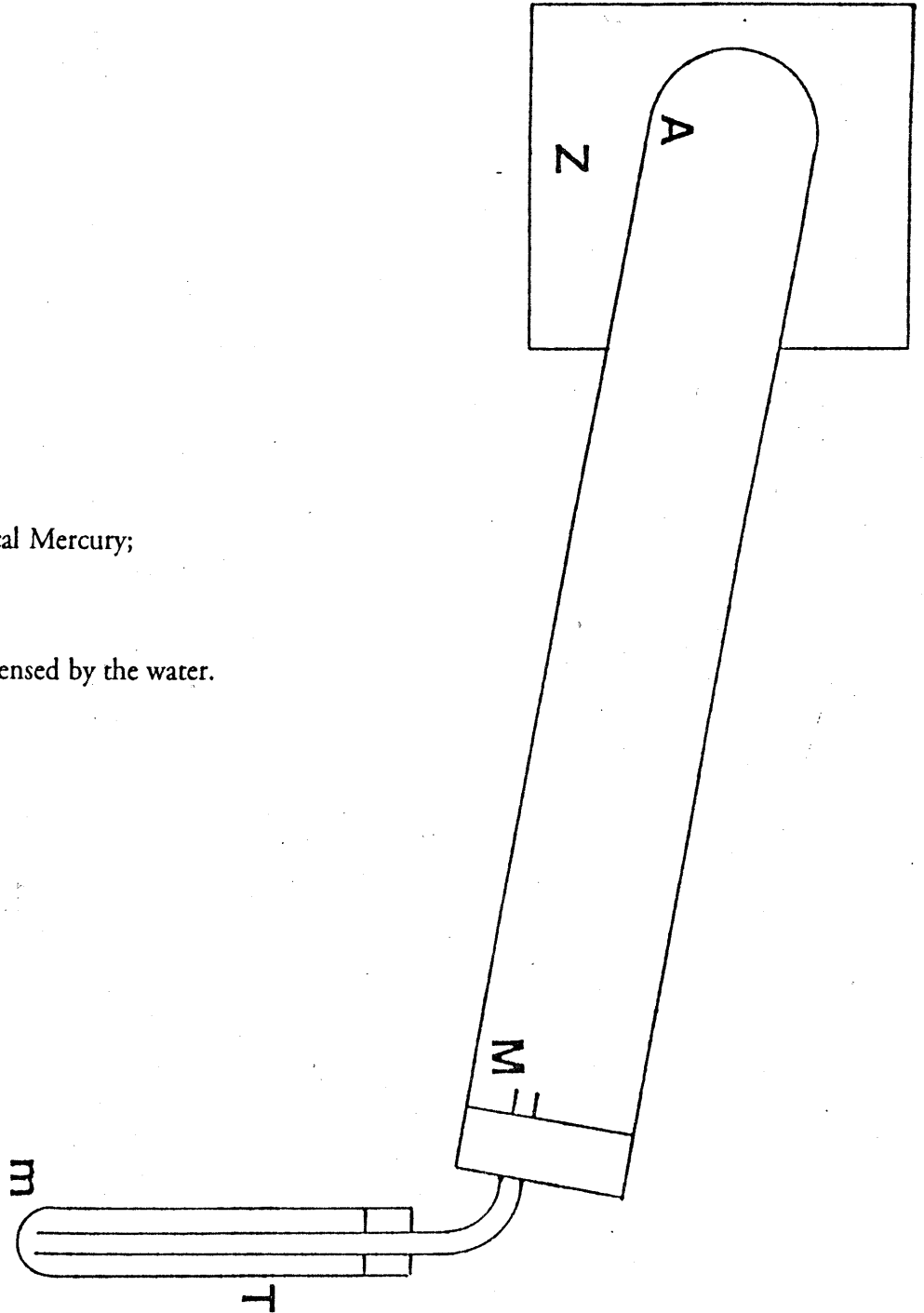

Figure # 2  
C.76.0490.

### DISTILLATION OF THE AMALGAM

- Z - Heating area or sand bath;
- A - Position of the amalgam;
- M - Position of the Philosophical Mercury;
- T - Safety tube;
- m - Mercury of the vapors condensed by the water.



## Legend of Figure # 1 Distillation of the mercury

This device allows us to distil mercury safely.

**B** - Quartz distillation flask. If the flask is made of pyrex it must be maintained by a sand bath **S**.

**b** - Stopper made of polyurethane.

**Th** - The thermometer is optional: if you have one, it should be of the 400 C type.

**C** - Safety tank preventing the water from coming back onto the hot mercury. Its volume should be greater than the volume of water **D**.

**T1** - Tube tapered at the bottom, help pass the mercury vapors over in the form of small bubbles in the water of tank **D**. Must go beyond stopper **b**. At first the water above **B** insures the water/air tightness of **b**, later the mercury insures it; so there can be no direct passage of mercury vapors between **C** and **D**.

**T2** - Prevents any superpressure and defines the level of the water in **D**.

**R** - Faucet to draw the distilled mercury.

**bc** - Stopper made of polyurethane or of rubber

**Note:** A mantle containing water placed around the devices prevents any superpressure when the distillation stops, the condensed mercury above **b** is then cooled down.



THE PHILOSOPHERS OF NATURE

Copyright © 1989 by LPN-USA

---

Lesson 77 - MINERAL - page 1

C.77.0590



Latone, the Mother of the Sun and of the Moon, must first be cleansed of her negativity.



Dear Friend,

This lesson deals with three different issues:

- The making a crushing device;
- The extraction of the red oil of antimony;
- The way of the acetates (note).

### THE MAKING OF A CRUSHING DEVICE

The crushing device used for the amalgam and described in Coelum Philosophorum is not very practical, and is hard to build nowadays. We suggest another, simpler solution, whose elements can be easily found (see enclosed figure ).

The container for the regulus or the amalgam will be a stainless steel pot, whose handle has been removed. This pot, forming a kind of vat will be held tight against a steel board by circles of plywood and by three 10 mm threaded rods. It is useful, in order to tighten the whole thing to have wing nuts handy.

The circle on the side of the steel plate is made of three sheets of plywood. The median sheet of a smaller diameter will form a pulley with a belt and will allow the crushing device to be set into motion.

The rotation axle is slanted at 45 % so that the mercury remains in the lowest part of the pot. If the axle is mounted on ball bearings, the the pump engine of a washing machine is sufficient to set it into motion.

The axle used in our crushing device is hollow and a steel tube of 16 mm comes out at the two ends. This tube is stoppered at its outer higher end, which allows us, during the making of the amalgam to pour the mercury progressively without having to undo the set-up or remove the container.

The vat will be furnished with 6 to 8 steel balls, of a diameter of at least 40 mm and 2 or 3 balls of a 15 to 20 mm diameter.

### EXTRACTION OF THE RED OIL OF ANTIMONY (A process to prevent bad odors)

This process is only valid if you have already built your LPN oven.

- 1 - Separate the stibnite from its gangue by fusion as already explained;

- 2 - Dry it and reduce it to powder with the mortar or with the crushing device;
  - 3 - Transform the stibnite - antimony sulfide - into oxisulfide with soft and long calcinations. The stibnite then takes a color close to that of litharge;
  - 4 - Prepare a wine vinegar, through freezing and distil it;
  - 5 - With the strong vinegar the copper oxide is attacked and yields copper acetate; coagulate it to obtain crystals of copper acetate;
  - 6 - Perform a dry distillation of the copper acetate to obtain the radical vinegar. Do not redistil to eliminate the "blue part". The presence of the "spirit" of copper in the vinegar is important;
  - 7 - Circulate the antimony oxisulfide in a soxhlet with the radical vinegar;
  - 8 - Eliminate from the resulting product a maximum of the free acetic acid through distillation. As this operation is not easy, do not overheat;
  - 9 - Eliminate the residual acid through circulation in absolute alcohol. In this operation the presence of free acid gives off a typical smell, that of acetic ether. Continue the circulations as long as this odor is present. Between circulations eliminate the acetic ether of alcohol through distillation;
  - 10 - Leave the acetate of antimony in an incubator for 1 to 2 months at 40 C; this long digestion will permit the energies to be transferred;
  - 11 - Perform a dry distillation to obtain the red oil of antimony which will contain the Fire of antimony plus the vegetable life that the acetic acid of the vinegar has brought in.
- \* Be careful, recoup the white vapours in a big flask; after several days, they will yield a few more drops of the red oil.
- \* The red oil obtained is identical to that of Basil Valentine but it is obtained in an easier manner and with a process that prevents the awful odors of the way of the acetate of antimony through soda.

## SAFETY MEASURES AND INFORMATION ABOUT THE WAY OF THE ACETATES

Reading reports of experiments along with our own experiments have brought us to the following conclusion:

The fermentation of a product that has already been fermented gives a fixed and fixating product; example: grapes give wine through fermentation, wine contains alcohol, the Mercury of the vegetable kingdom. The fermentation of the alcohol gives a vinegar containing acetic acid which fixates the mercuries and the sulfurs that come into contact with it.

The free acetic acid is a liquid that does not allow to transfer or to release the energy. This justifies the softening of the antimony acetate through alcohol in order to eliminate the acetic acid that has not been used and which later on would prevent the energy transfer.

#### About the Salts:

Several authors of alchemical works say that the salts do not exist in the metals before calcination. We definitely agree with this after having studied, researched and experimented with this fact.

Today, we say that what the ancients used to called calx (lime) - and in other cases salts - are but metallic oxides. Except for the mercurial calx of gold and silver.

For the alchemical functioning of the operations there is no difference in principle among calx, salt and sulfur.

In the oxide, the revived metal lives through the oxygen.

In the sulfide, the revived metal lives through the sulfur (column VI of the Table of the Elements).

The evolution will be infinitely faster if the oxide sustains the vegetable life, which is practically possible only with lead, which we shall consider.

#### Process of the acetates:

In the systems of Newton, Cockren and Paracelsus the basis of the processes used is the transfer of vegetable life into the mineral.

These processes function experimentally only with lead, not because Saturn is the Medium Coeli, but because the lead, with its four electron outer shell, has the same configuration as carbon and silicon; which renders the transfer of vegetable life possible.

Since the metal must be revived, the "state of death of its corpse" is not important to us; the best is to choose what will be most favorable for the remainder of the work. In the case of lead, choose minium which is the oxide containing the most oxygen. The only condition is that the minium should be as pure as possible.

To obtain a result, we must awaken this corpse and attempt to inject into it the Fire of antimony and the vegetable life.

Life will come from the vine through the following steps: vine - grape - wine - vinegar.

The Fire will come from the antimony, about which we have already said that it is an immortal metal, through the following stages: stibnite, oxisulfide, acetate, red oil.

It is the red oil whose making has been described above, and which contains these two energies.

The imbibation of the minium with the red oil will give the following situation:

The minium, owing to the oxygen it contains, will start its metallic evolution anew through the life brought to it by the antimony and it will be accelerated by the elements of the vegetable consciousness. We must consider that minium, a body that was dead, starts its evolution again from the level of antimony, and that it will reach the silver, the white stage of the work, but can only go beyond this stage if the "spirit of copper" has not been eliminated from the radical vinegar. The technical details of the fixation of the red oil in the minium have been given in a previous lesson.

The energy transfers always happen in the order of the planets, or of the traditional metals, or in the ascending direction, or descending one, but it is impossible that it jumps over one of the steps. In what precedes, the "vegetable spirit" is what permits to go beyond the energy level of the silver.

#### Energy transfer in the amalgams:

This shed an incredible light on Philalethes' works on the amalgams. In this way, the regular mercury is revived, but as explained by Van Suchten, the mercury cannot be revived without the presence of silver. There are two reasons for this: one material, the mercury-regulus amalgam cannot be formed, an intermediary is necessary, i.e. the martial regulus must become a lunar martial regulus to be amalgamated to the mercury; the other, an alchemical one, which can be expressed by saying that the Fire of antimony must become lunar to be accepted by the Mercury.

Suchten, *Cœlum Philosophorum*, Philalethes and Lapidus are not very talkative about the next steps. However to go further copper is necessary because Mercury can only reach the gold through the intermediary step of copper. In this case, we need either a lunar martial regulus or a venusian martial regulus. But *Cœlum Philosophorum* proposes a lunar venusian martial regulus, a regulus capable of bringing the work to the red stage.

If Van Suchten in his text makes a clear synthesis of the first part of the process, we find the practical details and information about the copper only in *Cœlum Philosophorum*.

Ora et Labora!

#### THE PHILOSOPHERS OF NATURE

Figure enclosed:

- The crushing device

Figure  
C.77.0590

### THE CRUSHING DEVICE

set-up to fix the crushing device  
(can be made of wood)

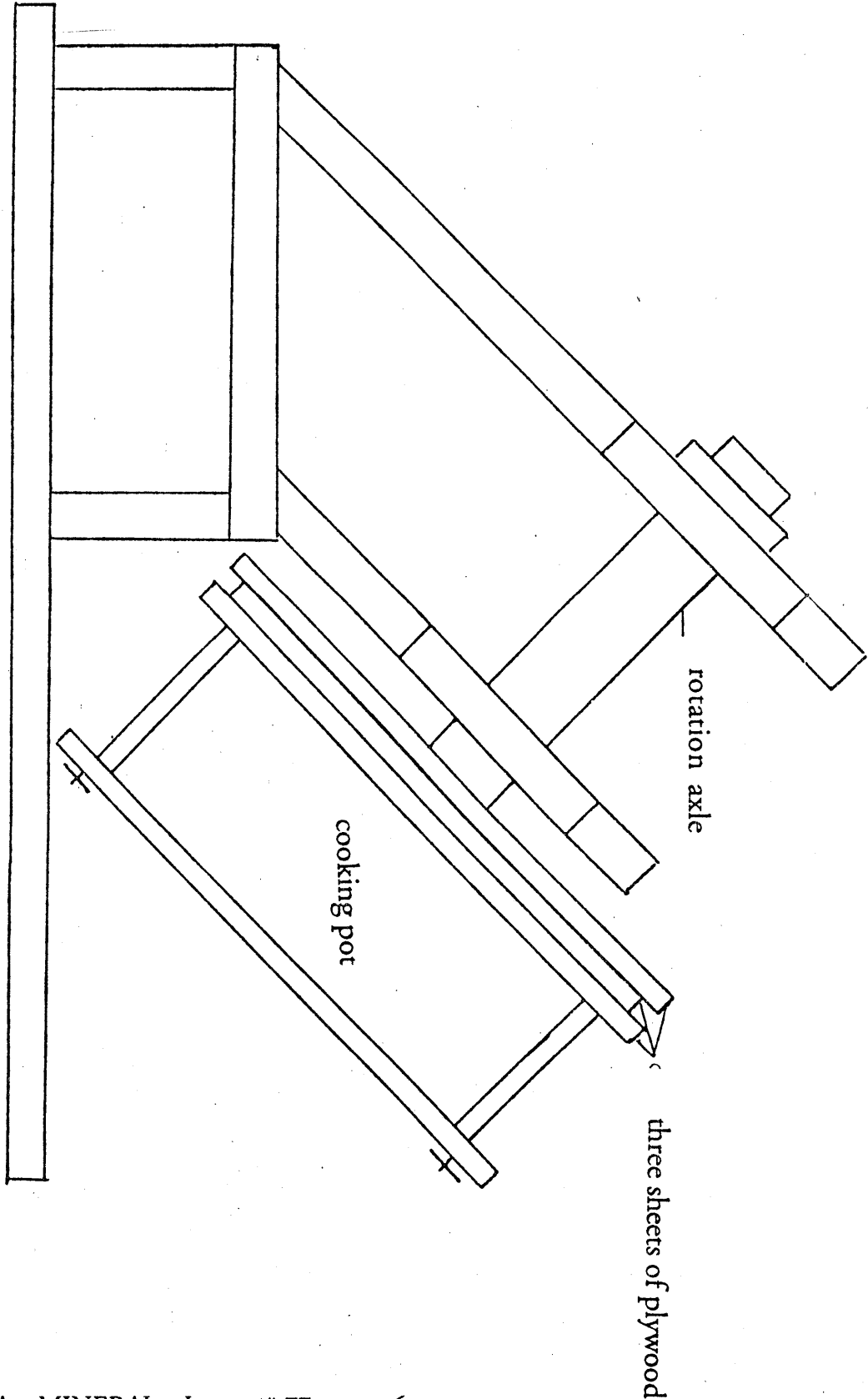

# THE PHILOSOPHERS OF NATURE

Copyright © 1989 by LPN-USA

---

Lesson 78 - MINERAL - page 1

C.78.0690



Saturn, the Medium Coeli, symbolizes the necessary spiritual ascent. But its Chronos side symbolizes the element time: patience.

Dear Friend,

## MAGNETIC ENERGY

Science now believes that all energy, therefore all things, have both an electrical and a magnetic side. For example, about the electron, we speak of its electrical charge and of its magnetic momentum, the spin. Thus, all that which is alive manifests electrical and magnetic energy.

As for the subject concerning us, we will say, in modern words, that iron will assume the magnetic factors in the process of the amalgams. And if we ponder about it, we can understand Sigismund Bacstrom's commentaries when he states that he prefers steel to iron. If we take a magnet and we join its two poles by an iron nail, the bigger nail can attract smaller nails to itself. But if we take the big nail off the magnet, the small nails will fall off. If we begin the experiment again with a steel rod, the small nails remain stuck even after the magnet has been removed from the rod.

- iron has a volatile magnetism;
- steel has a fixed magnetism.

The use of steel in the regulus of antimony will give a fixed magnetism, the use of iron a volatile magnetism.

We think, today, that iron is sufficient for the "white stage" of the work but that steel is necessary for the more time-consuming work of the "red stage".

### Remarks:

Iron becomes steel if we add to it the carbon of column IV. The silicon of this same column improves the magnetic qualities of the iron. Therefore the iron is not necessary in the ways using the vegetable or animal energies for it is the carbon which takes on these functions. But in the intrinsically metallic ways, steel or iron is necessary.

In our opinion, in animal or vegetable life, a kind of "atomic division" takes place which makes the 4 become 2 and this 2 can then take on a magnetism whose manifestations are very different from that of the mineral.

In the analysis of the animal realm and that of man, in particular, do not forget that the stomach contains the acid of the sea salt whose number is 8 (2x4).

After the preface of the Coelum Philosophorum, we will exclusively move on to the practice using this text, but only after we have reordered it and eliminated the traps as well as most of the useless parts. In this treatise, the procedures of some of the operations have been cut in pieces and spread throughout the text. We will then group the spread elements together again and will strive to remain in agreement with what we believe to be the good procedure of the operations, or:

- The preparation of the various regula;
- The preparation and animation of the mercury;
- Seeding of the mercury and digestion.



# COELUM PHILOSOPHORUM

that is

A faithful Instruction  
founded on practice and confirmed by Experience  
how not only by the Via Mercurii Metallorum  
in the dry and humid Way the hermetical  
Treasure may be fully obtained,  
but also  
how to elaborate particular tinging Me-  
dicines from all the Seven metals and  
Various minerals;  
with  
powerful and Safe Medicines to heal  
Diseases otherwise incurable;

out of love towards  
our fellow Creatures  
Communicated  
by  
an Admirer of fundamental Chemical  
Science.

/: S.C.:/

DRESDEN and LEIPZIG 1739 OCTAVO

Translated from the German

\* \* \* \* \*  
\* \* \*  
\*

In this text, the commentaries are by S. BACSTROM and the notes by L.P.N.

## PREFACE OF THE AUTHOR

**Note 1:** The preface contains elements whose study is very important for the remainder of the text. (We have underlined some sentences).

Benevolent Reader:

If thou art a Lover of the more sublime part of Chymistry and intendst to learn and do something practically without hurt to yourself, this Treatise will be useful, as the author is not envious, but will be glad if some good is done through his good meaning.

The author has on an Emerald Foundation (alluding to the Tabula Smaragdina Hermetis) laid by Hermes, built his philosophical Heaven.

The author does not intend to perplex the lovers of this difficult art, which is nevertheless easy enough to those that know it, but he proposes to give light.

The Lights on the Heavens give and Cause us Light, Signs, Times, Years, and days. It is Similar to our philosophical Heaven, alum, iron, copper, mercury, antimony, vitriol, give us golden Tinctures, whilst, Moon, Jupiter, Saturn, Mercury, Sun give us only silver Tinctures.

The road to our philosophical Heaven is Overgrown with Thorns, and those that travel this way are conducted in a wonderful manner. Sometimes men are lead into it innocently, sometimes through Ignorance, by Some accident, by Covetousness, by persuasion, by natural Faith and Confidence, by Great Expences, Labour and Diligence, by Experience and Sometimes by Imposture and false Transmutations.

It is however certain that no man will ever attain a happy End in this dangerous Science except he is possessed of an Innocent Heart and unblamable Character.

It happens very seldom to meet with an Adept, who should be willing to communicate, or even make himself Known to us.

Knowledge, Labour and Patience are the most useful companions on this Road, whosoever does not possess them all three will never obtain what he seeks.

It is Strange that there are men, who otherwise do not want for Good Sense, who should philosophize either against this art or in favor of it, to mislead honest Lovers into fatal Error, whilst they know as much when they write against it, as they do when they favor it. Some are very mysterious, they write of things which they Know nothing of themselves. They also mislead the industrious Searchers into a labyrinth of Errors.

The Matter of their Stone is a heavenly matter, has no name, is everywhere, but Known by none, but the Adepts! This can only be allowed in part, as the first subject we take in hand must be visible and tangible absolutely.

Who Soever has studied the genuine writings of the Philosophers, will easily comprehend, that without a visible and tangible Subject and much pains labour and patience, nothing of any moment was ever done in this art; understand the preparatory labour of Bodies; as this art does not busy itself with Soft Eggs, but with hard metals and ores, to **Subtilize and exalt them, which requires Knowledge, Labour and patience and some Expenses.**

This Treatise has been written, by the Blessing of God to instruct Serious Lovers of this art, such as possess a sound judgement, if they will but follow the Simplicity of Nature!

## OF GOLD AND ITS PRINCIPLES

**Basilus Valentinus, Paracelsus, Monte Sneider** and others have demonstrated 3 principles, viz.: metallic salt, metallic sulfur, and metallic mercury. **Becher and Stahl** demonstrate 3 kinds of earths viz.: the vitrifiable or fusible salt, the inflamable sulfur, and the liquifiable or specifically mercurial mercury, in metals.

Anterior Philosophers have mentioned only two constituent principles of the Metals, viz.: Sulfur and Mercury. These were **Lullius, Bernardhus Trevisanus, N. Flamel.**

The Oldest were satisfied with **On principle only, viz: mercury**; those attributed the **Difference of Metals to the Maturation and Fixation of that mercury, with a mixture of metallic external earth.** This Opinion, if referred to the nearest matter of metals, appears to me to be the truest and the best, because this can be confirmed and proved but the anatomy of metals, although We must allow that Minerals and Marcasits yields a sulfur a mercury and a salt. The remotest principle is a vapour in the Mines, wherein the Universal spirit is specific!

## OF IRON

Anonymous Philaletha has written: "from the North toward the West there is a Hill, which is one of the Seven and the Second from the highest. In this Mountain the Spirit is hidden, which accomplishes our work."

This is to be understood as follows:

the Seven Mountains are the seven planets or metals: Saturn, Jupiter, Mars, the Sun, Venus, Mercury, the Moon. The North towards the West means the lead, the West is silver, Iron is the Second from the highest, i.e. lead.

In another place where he Speaks of the Sophic Mercury, he Says that he is hidden in Iron.

"Eum intellige Mercurium, quem Sol in Martio, i.e. in Marte iron, Oriens per omnia Mundi i.e. per antimonii Lof Diffundit."

In common Iron is hidden a most Subtil Spiritual gold, not obtainable by Vulgar processes, but by Such as We have already taught you Where We treated of gold and of the martial regulus of antimony.

Here we mean to say something further concerning that philosophical gold. We intend to be as intelligible as possible, firmly persuaded that Divine Providence directs its Success.

**Note 2 :** Note that the order of the metals is the order of energy circulation.

### MARTIAL REGULUS ET SCORIAE PRIMAE

Take iron in Small nails or Filings 1 part, good antimony 2 parts, melt them together as you know, then take tartar and sal tin equal parts, reduce them to fine powder and mix the powders, project by degree some of your powders, previously heated, on melted iron and antimony in the crucible on 1 pound of the Subject, you project about 2 ounces, of your powder, in order that it may flow the better and that a proper Separation of the Scoria may take place. Let it cool - Beat the regulus from the Scoria

**Note 3 (and reminder):** The good antimony is stibnite that has been separated from its gangue. The mixture of salt may also be potassium carbonate 1 part, potassium nitrate 1 part (saltpeter). Weight of the mixture of salt is equal to the weight of the stibnite.

The usable scoriæ are those obtained by the first reduction of the stibnite into regulus only.

### USE OF THESE SCORIAE

Beat the Scoriæ to powder in an iron mortar and weigh them/: if you let them attract the air in dry weather they become a black dry powder in 2 or 3 days times:/ grind with these Scoriæ and equal Weight of sal ammoniac, grind it with a deal of Care, put the mixture in a wide mouthed glass Body, which lute all over the bottom to enable the glass to withstand Strong heat.

**Note 4:** The sal ammoniac must be sublimed several times for this use.

Then place the body in a sand Capel, in a Charcoal furnace, give gradually and at last a Strong heat, So that the Scoriæ and sal ammoniac may melt together in the glass body, which you Cover with a thin piece of Tile or a crucible Lid.

During this fusion of the mixture, the sal ammoniac ascends above the Scoria and forms a white crust, and this is called Subliming the sal ammoniac from the Scoria.

Take it out as well as you can, powder the 2 Substances together, and let them flow again as before, let it cool, and you will find the sal ammoniac sublimed above the Scoriæ, as before mix and powder the Substances again, and Sublime them a third time.

This process must be repeated, adding the 4th, 5th and 6th time a little fresh sal ammoniac, until the Scoriæ are intimately united with the sal ammoniac, which will appear by their fine Red Colour.

**Note 5:** We only obtained and orange-red color.

## USE OF THESE SUBLIMED AND SUBTILISED SCORIAE ON SILVER

These Scorïæ contain the sulfur of iron and antimony.

Take fine silver in thin plates, stratify it with the above sublimed Scorïæ S>S>S> in a crucible, and lute a Lid on; Cement this 3 days and nights, beginning with a moderate fire, all around the crucible, which you approach gradually nearer and nearer from 6 to 6 hours, until the last 12 hours the crucible becomes of a dull red heat.

Let it cool, dissolve your silver with aqua fortis, and you will find how much of your silver has been fixed into gold by the spiritual gold of iron and antimony.

Mars by himself can do no more, but if you take the Spiritual gold from him, you can proceed therewith as we have told you in the first section of Gold.

These are no Speculations but real Truths. If you add antimony to the iron, the Effects are far greater; In the manner as follows:

**Note 6:** This experiment on silver is not necessary. It is outside the path.

## MARTIAL REGULUS WITH COPPER

Take iron half a pound, good copper quarter of a pound, glow them to a white heat in a crucible, then project one and a half pound of good antimony, in coarse powder, previously heated.

Let the Substances flow well together, and add in 3 or 4 different times 5 or 6 ounces of your fluxing powder composed of nitre and tartar salt, previously well heated, let them melt then like water, and pour the mixture out, intensely hot, raising your heat for a few minutes by the blast, that moment pour it out into your well heated and oiled antimony horn, and let it Stand to cool.

When sufficiently cooled, beat the martial venusian regulus of antimony from the Scorïæ. Beat the Scorïæ to powder, and boil the salt out of them with water. Filter this water and Coagulate it into salt. This salt is Very useful for the Cementation of silver.

The elixivated Scorïæ you must dry and mix them with an equal weight of sal ammoniac.

Put the mixture into a wide mouthed glass body, cover it with an alembic, to close it and in the mean time you get clear of the humidity. Put the body in a sand heat and increase your fire gradually, until the mixture flows like pitch, increase your fire, until the sal ammoniac Sublimes above the Scorïæ.

This Sublimation with sal ammoniac must be reiterated 5 or 6 times, as has been taught before, until the massa ascends of a fine red colour with the sal ammoniac.

If you pulverize these Sublimes Scorïæ and Stratify them with an equal Weight of fine silver and cement it by a graduated fire, you will find in every Marck of silver, half an ounce of gold and 1 ounce more of silver.

(I do not think that this would pay for times and expences, but it is nevertheless a proof of the tinging power of iron, antimony and copper).

(Cementation is the most difficult Operation in Chemistry) if you make a butyrum of the above martial venusian regulus of antimony with sublimed mercury, and fix that butyrum on tin ashes, and afterwards Copel those tin ashes, and afterwards dissolve the New Substance by aqua fortis, you will obtain fine silver and fine gold.

(Another proof of the tinging power of iron, antimony and copper).

**Note 7:**

- 1. It is better to keep these scorixæ for a later experiment;
- 2. In the chapter about cementation, there is an interesting clue on the animating mercury using the venusian butter of antimony;
- 3. The author here starts from purified stibnite. He does not attempt the incorporating of the copper into an already prepared martial regulus.

Ora et Labora !

THE PHILOSOPHERS OF NATURE.



# THE PHILOSOPHERS OF NATURE

Copyright © 1989 by LPN-USA

Lesson 79 - MINERAL - page 1

C.79.0790



Ordinary mercury becomes Philosophical Mercury when you add to it the Secret Fire.



Dear Friend,

In the Mineral Lesson # 76, we saw the transformation of the stibnite into a regulus.

The work presented here is slightly different. It is the preparation of the lunar martial regulus necessary for the animation of mercury in the process of the amalgams.

Note in that text the advice to use steel.

## COELUM PHILOSOPHORUM (continued)

### OUR METHOD TO PREPARE THE SOPHIC MERCURY AND FIRST THE MARTIAL STELLATED REGULUS OF ANTIMONY

Take thin iron plate in small bits or a thinly beat or laminated iron barr, let it glow of a white heat. (I would take a thin steel barr or steel rod, as steel is a little more pure than iron).

Set a roomy crucible in your wind furnace: put therein a much good antimony as you like, about one half full, and let it flow thin: hold the glowing iron or steel rod into the antimony, and the melted antimony will dissolve as much of the steel as the antimonial sulfur can overpower. (I would take a thin steel barr or steel rod as steel is a little more pure than iron).

The pure reguline part of the antimony with the central solar principle of iron are here separated from the coarse adustible external sulfurs of antimony and iron, and thus the pure part is precipitated to the bottom of the crucible and is called regulus, whilst the coarse part of scoria remains at the top, being less ponderous and more volatile. When cold, beat the regulus from the scoria with a blow of the hammer. (The rationale of the operation)\*. Do not throw away this first scoria, which is black, but preserve them for future use, whereof I shall treat in the chapter of iron.

### PURIFICATION OF THE REGULUS

Take half a pound of your regulus, no more, beat it to a coarse powder, let it melt in a clean new crucible, as soon as it is melted project finely grounds niter, made hot, on the flowing antimony, so as to cover the antimony entirely, raise your fire sufficiently that the niter may flow thinly over the regulus.

Let them melt together quarter of an hour, and then pour it out, whilst you raise a great heat, into your Cone, well heated and oiled. This time your regulus will be purer than before. When it is cold, beat the regulus from the scoria; the scoria put by.

Beat your regulus again to a coarse powder and melt it twice more, each time projecting a little heated niter in fine powder, as you did before, and your regulus will be pure enough and finely stellated.

Some look upon this star as a remarkable sign of purity, but they are mistaken; if you melt it well and pour it out exceedingly hot, whilst it flows very thin like water, boiling hard in the crucible, you will after the first Rectification, always obtain a stellated regulus.

Some want to attribute the star to the weather, but they are blind. Let the weather be how it will, only proceed right, and you will always have a starry regulus.

(I have made the stellated regulus above 30 times in Mary le bone and never missed, yet I would advise to melt, if possible on a serene day, as the fire burns clearer, when the air is pure).

The production of the star is mechanical and depends upon the subject flowing very thin and pouring it out quickly, whilst you raise an intense heat by the blast for 4 or 5 minutes, and the moment you have poured it into the heated oiled cone, you beat a few gentle blows with an iron rod or chizle round the brim of the cone, this causes an undulated motion which causes the star. Stahl has also observe this before me.

**Note 1:** When all the regulus has melted in the crucible and when the niter is liquid, there is on the top a boiling of molten metal; do not attempt to pour as long as this boiling has not ceased otherwise projections of molten metal may occur.

### FURTHER ANIMATION OF THE REGULUS WITH FINE SILVER

Take of your last purified regulus, beat to powder, 2 ounces as much again, i.e. 4 ounces fine silver, containing neither gold nor antimony for certain reasons.

Melt the silver first, then add the heated regulus in powder, as soon as they are melted and united, pour the mixture out in a clean heated iron cone, whilst it is yet warm, beat it in a hot iron mortar to a coarse powder.

**Note 2:** Be careful, contrary to what has been said in this text, the silver should not be melted but dissolved by the regulus.

We believe that the weight of silver used is exaggerated, because the silver here is a mere transfer agent. The silver recuperated by the process described in Mineral Lesson # 75 is in the form of nitrate, it can directly be mixed with the regulus powder.

The weight of the silver nitrate must be about twice the weight of the silver. The less silver there is, the longer the formation of the amalgam.

The dissolution of the silver by the antimony must be complete.

Gloves are mandatory for this experiment.

## OF THE SOPHIC MERCURY

The Stone of the philosophers is nothing more than a subtilised exalted and seminal gold, therefore we need an agent or penetrating powerful principle capable to effect such a subtilisation and exaltation; all the philosophers require this principally!

This agent in our process is mercury, the common running mercury, yet this mercury must undergo a previous preparation. Such as are displeased with the simplicity of nature, will not be satisfied with this our doctrine; but we leave fools to their own conceit and follow nature's simplicity.

The mercury which we use is certainly not the common mercury bought at the shops. Our mercury is truly the philosophical mercury, nay a son of the philosophers; because by an ingenious art it is prepared with a deal of trouble and patience, as well as the philosophers gold, or the philosophers Sol, so named, because it is also prepared by the Philosopher, although from natural subjects.

Supernatural phantastical people, who require every thing to be wonderful and unreasonable will not be pleased with my simplicity: for such I write not!

### PURIFICATION OF COMMON RUNNING MERCURY FOR THIS OPERATION

The mercury we use is common fluid mercury, but it must be pure. The best method is to buy whole block of cinnabar or cinnabar in pieces, suppose one pound, if you buy it in powder as vermilion, it is adulterated with red minium, and martial regulus half a pound. grind each separate and mix the two powders in the mortar; grind the mixture until the powder is impalpable.

Put the powder into a retort, apply a receiver filled with water, so that the water is nearly to the mouth of the retort, do not lute the joinings. Distil now by a graduated heat and the running mercury will come over and drop into the water.

The common sulfur contained in cinnabar is by means of the regulus regenerated into common crude antimony, which remains behind in the retort.

The fluid mercury obtained this way, must be ground with clean and pure flowers of sulfur, until mercury disappears and is become a subtil black powder this is soon done in the grinding engine.

Then sublime your black powder into cinnabar. From this cinnabar one part and martial regulus half a part distil again the fluid mercury, exactly as you did before, and this labour must be done 3 or 4 times, and you will obtain a beautiful purified mercury, which will be sooner perfected by the succeeding animation, than any other mercury not purified in the manner directed.

The regenerated antimony proceeding from the regulus and the sulfur in the cinnabar is good to make regulus again if you add steel or iron.

**Note 3:**

- 1) The purification of the mercury may be done through distillation (device already described) but three distillations are necessary;
- 2) The process described by the author may present the advantage that a certain transfer from the fire of the antimony is possible in this operation;
- 3) In that case, we use a sulfur from a volcanic origin, purified through extraction in the soxhlet with carbon tetrachloride. Coagulation and drying in a glass dish in the sun.

### AMALGAMATION OF THE LUNAR REGULUS WITH PURIFIED RUNNING MERCURY

Take the above powdered lunar regulus and put it in a warmed smooth iron mortar, add 4 times as much purified mercury, which purification shall be taught hereafter, 4 times as much as the silver did weigh, which you added to the regulus, when you melted them together; but this mercury must not be added all at once, but by small quantities only, about 1 ounce at a times and no more.

**Note 4 :** We must add the mercury in small quantities only through the tube of the crushing device. At about 2 thirds of the quantity of mercury planned for, take out the set-up and look at the amalgam: if free regulus is left, add some more mercury in small quantities. You can only examine the amalgam after at least 10 hours of rotation of the crushing apparatus, preferably after 20 hours.

Grind quickly with a swift regular motion and the mixture will become an amalgam.

Note that it must be ground diligently for a considerable time.

I advise you to have a grinding machine made and to have your iron mortar turned out smooth in the inside and the pestle polished.

In such a machine, the labour is easy, and the effect is infinitely greater, and the intimate union is obtained in much less time, than if you were obliged to labour and turn with your pestle. Whosoever cannot afford such a machine, which need not to cost a great sum, must content himself to move round the pestle with his hand like Hercules.

For that reason some Philosophers, having had no conception of a grinding engine have called this preparation of the mercury an herculean labour.

ENGINE FOR AMALGAMATING PURIFIED MERCURY  
WITH THE LUNAR MARTIAL REGULUS STELLATUS

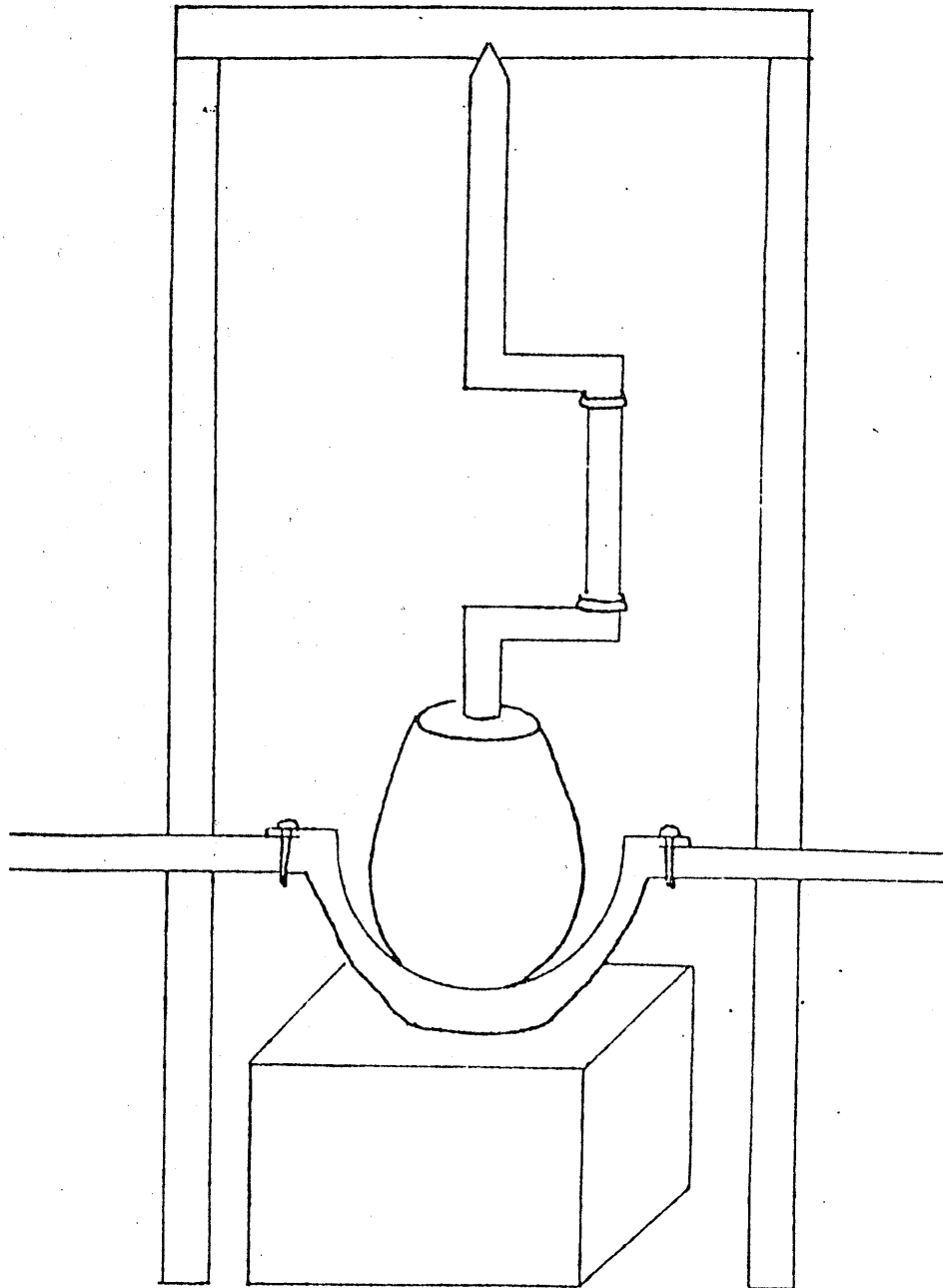

The mortar must be made of cast iron and must be turned in the inside and polished. The pestle the same must be turned off on the outside.

**Note 5:** We have kept the description of the crushing engine of the original text to indicate that the steel amalgam contact is without drawbacks.

This labour of amalgamation, whether it is done with the engine or with the hand only in a mortar, must be continued a good while, and the amalgam must after that, be washed so long, until it yields nor more blackness, but appears as bright as a looking glass.

### DISTILLATION OF THE MERCURY

Then put your bright amalgam into a small glass retort, place this in a sand pot, over a charcoal fire: adapt a receiver half full of water, and distil the running mercury over into the cold water, and your niter from the lunar regulus will remain behind in the retort. These are the dead Doves of Diana. Thus your mercury has been distilled once, which distillation is the Philosophers sublimation; because the solar volatile mecurial principle of iron and the mercury of silver, ameliorate here the common mercury, your distilled mercury you must wash again.

The black powder which you wash away from the mercury, you must put by and save. As soon as the blackness is settled, pour the water off carefully, and dry your mercury.

Weigh your silver which remains in the mercury, and melt it again with half its own weight of fresh martial regulus stellated, and it will be a brittle mass, which beat to powder. Amalgamate this with your dried mercury, you have distilled over, either in the engine or by hand labour, grinding until it is perfectly united: distil the mercury over as you did before, and wash the mercury perfectly bright, the black dust save and put with the first, and dry your mercury.

The silver which remain behind in the form of a calx melt again with half its own weight in new regulus, powder it and amalgamate in the engine with your distilled washed and dried mercury, as before, and this operation must be repeated 10 times in all, then is the mercury prepared and animated, and is now become the genuine mercury of the philosophers (The ten Eagles).

**Note 6:** The black powder eliminated during the washing is comparable to the scorix of the first pour of the regulus. The scorix are bearers of "seed".

The ten repetitions of the operation are necessary because the transfer of the Fire of antimony is only gradually taking place. The regulus being exhausted in Fire by the operation can no longer be used.

### ULTIMATE RECTIFICATION OF THE SOPHIC MERCURY PER SE

Take now your sophic mercury prepared by ten eagles or philosophical sublimations (distillations) put it in a small glass retort, which bury in the sand, and distil your sophic mercury over into a receiver half full of water, wash your mercury and dry it in the sun or in a gentle heat.

This should be done 2 or 3 times but no more as this mercury leaves at every rectification a small portion of subtil gold behind, wherewith it is animated.

Dear Friend,

## THE SOPHIC MERCURY

If we have followed the information previously given, we must now be in possession of the Philosophical Mercury of the dry ways, i.e. common mercury reanimated by the Fire of antimony and by the principles of life, i.e. the seeds of iron and possibly of copper. If there is no copper, the work still stop at the white stage, which has not been indicated in the text, but which is the way it must be.

The seeding of the revived mercury by the lunar martial regulus is silver..

The seeding of the revived mercury by the lunar and venusian martial regulus is the Sophic Gold.

The seeds are extracted from the metals or from the scoriæ proceeding from the first preparations.

## MANIPULATING FIRE

We have said: the fire of the earth excites and animates the Celestial Fire. In Nature already with a temperature of 20 C, the vegetable Fire is reactivated, the seed germinates and sprouts. With a temperature of 37-38 C, the animal fire is reactivated but, be careful, at a temperature of 42 C the animal fire dies.

In the sequence of the operations, never confuse the fire which excites the Secret Fire and the fire which fixates the elements.

In the study of the Cœlum Philosophorum, it would have been logical to study silver before gold, but, the operative part which is almost identical for the two, is only described for the gold, consequently it starts with this metal.

\* \* \* \* \*

\* \* \*

\*

# COELUM PHILOSOPHORUM

(continued)

## GOLD WHAT IT IS

Gold is a very pure metallic body full of light: extremely simple, as to its essence - a perfectly matured mercury, without any external addition. This we believe, because the whole substance of mercurius vivus, provided it be well purified and animated, can by simple digestion be matured and fixed into pure gold! Nay more than that!

Therefore we conclude that mercury is unripe gold. In the same manner common gold, so highly fixed by nature, can be retrograded and reduced into running mercury: it follows from thence that gold must be pure fixed mercury. Therefore let us be satisfied with experience.

**Note 1:** What follows is the way of the gold-metal, and not of the Sophic Gold; in our opinion, this way should not be taken (way of Urbigerus) but it seems essential as a subject matter, in order to study the experimentation.

## MERCURIFICATION OF GOLD

The mercurification of gold is performed in the easiest and most natural way be common running mercury.

For that reason the oldest philosophers have told us: "Make mercury by or with mercury." Whereby the whole substance of gold, without any loss, is transmuted into living mercury.

This nevertheless requires judgement and certain degrees of operating. The most principal are calcination, amalgamation, digestion and distillation.

By these four degrees of operating gold is reduced to running mercury. Out of this mercury if gold by digestion alone, a noble medicine for the human body and even a perfect tincture for metals can be made. (This was one of the processes of Sebald Schwartzer, which he communicated to Augustus pius elector of Saxony, in the year 1570, and to his spouse Anna; which red tincture acted on 10,000 parts of mercury. (See Baron Kunkel von Lowenstern's Laboratorium Chemicum).

We begin also with the:

## CALCINATION OF GOLD

Gold is calcined by various methods: amongst all of them, I found the following the best, by experience:



**Note 2:** The purification of sea salt, necessary for the sequence of these operations will be described further on into the text.

Now take refined gold, which has been purified either by antimony or has been reduced from the quart: get it laminated at the flattening mill, or let it be beat into thin leaves, which amalgamate with as much purified mercury as it wants - suppose gold purified and laminated or in leaves one ounce, add purified mercury 4 ounces: amalgamate it with great care and do not mind the trouble of grinding it well.

When it is well amalgamated, squeeze the amalgam through smooth chamoy leather, in order to press out the superfluous mercury. The amalgam which remains in the skin you must wash with common salt and vinegar first, and then with clean water, repeating this operation until the amalgam is as clean as a looking glass - then dry it in the sun or in a gentle heat and it will become hard, so that it may be pulverized.

Take now your dry amalgam and grind it with three times its own weight of your purified sea salt. Grind it with great diligence in a glass mortar, previously heated, and it will and must become a subtil black powder. Put this powder in a convenient small glass retort, adapt a receiver, half filled with pure water, and distil in sand increasing your fire gradually, until the running mercury is come over into the water.

Th mercury which settles in the neck of the retort, must be carefully swept out with a clean feather of a goose quill, that it may not collect and fall back into the body of the retort.

On the calx which remains in the body of the retort, pour clean water, set the retort again in the sand furnace, and give a gentle fire, so that the water may simmer gently on the calx and dissolve and extract all the sea salt. The meaning is not to distil the water from the calx, because the salt would still remain behind: the salt is to be dissolved in the water by this process. Then shake it up in the retort, whilst it is yet warm and pour it out, the water and the calx: let the powder settle and pour the water off carefully; the remainder pour into a filter and let the water run off carefully; the remainder pour into a filter and let the water run from it. Then dry the subtil powder of gold. The water and running mercury in the receiver must be poured out, the water separated from the mercury, and the mercury must be dried by evaporating the remaining moisture from it, in such a gentle degree of heat as will raise the humidity but not the mercury, or in the sun.

Repeat this same process with this calx of gold and with your same dried mercury twice or 3 times more, and when finished your gold will then be well calcined.

**Note 3:** Calcine means to reduce into calx; a calx no longer needs calcination. It is a trap for those who do not know.

This is nevertheless only an external calcination or subtilisation; yet this preparatory labour is highly necessary, because it promotes and accelerates the succeeding operations.

## AMALGAMATION OF YOUR POWDER OF GOLD WITH PURIFIED AND PREPARED MERCURY.

Now take half an ounce of your tender calx of gold, and amalgamate it with one ounce of purified animated mercury, by a long continued equal grinding in a warm glass mortar, as you did before. That is you are to take one part of calx of gold and 2 parts mercury sophic; wash your amalgam perfectly clean, and lay it in a clean glass or China Bason; cover it with clean paper, that no dust may get into it; and let it dry gently, so that it may be handled and yet hold together.

Then with very clean fingers form this mass into small pills, or the size of a green pea; lay these pills on a China dish, which place in the Sun,, or on a very gentle warmth, or even in a warm room, covered with clean paper, in order that all humidity of elementary water may evaporate from them, and the pills become hard and perfectly dry.

(The preparation of the mercury sophic, whereon the success of this process depends entirely, is taught hereafter: it is the sophic animated running mercury of Iranaeus Philaletha,, Espagnet, Claveus and Alex Von Suchten; but this is the long way with corporeal gold subtilized, whilst Irenaeus has a shorter way without gold, as we have fully explained in our manuscript: without name or date; yet this process is certainly genuine and safe, although very laborious).

Glasses:

You must now get a dozen of digesting globes made of the best glass, stout in substance, as nearly to this figure and bigness as possible; not bigger, as this is full big enough. They must have glass stoppers nicely ground in, so as to be air tight. (If they are made a little stronger yet, than this drawing; it is so much the better on account of the grinding the stoppers in.)

### DIGESTION

Take now one of your digesting globes, and put therein your amalgam made into small pills. If the globe is no bigger than this, your amalgam or pills must weigh no more than 1 and a half ounces. The amalgam must never fill above half the globe. Place your globe in warm sand in your digesting furnace and tie a piece of paper over the opening of the phial, until every humidity is evaporated, which in a gentle heat is done in 24 hours.

When you perceive no more humidity in the neck of the glass, shut it with the glass stopper close.

Continue the digestion in a very gentle heat, and during the first week the amalgam begins to contract, and, as it was divided before in small globes, it becomes now one only mass, dark in color, and puffs up or swells, like fermented paste near the fire.

## THE DIGESTION CONTINUED TO A RED POWDER

In this gentle degree of heat, sufficient to excite the above mentioned fermentation, it must now be kept night and day, until it becomes a dark dusty red powder.

But before this comes to pass, you will see curious phenomena in the glass globe, and never the same alike, nor in one glass as it happens in another, although you should enclose exactly the same weight of amalgam in glasses exactly alike and in the same degree of heat; which I can attest to you from a great deal of experience.

I shall only relate to you the most remarkable changes and phenomena I have observed myself, which have happened to the matter.

### SIGNS AND PHENOMENA

After the amalgam has stood in gentle warmth, 15 or 16 days, it grows upwards like branches and leaves of trees, and on the sides of the globe the mercury fixes itself, and causes part of the globe to appear like a looking glass. But when afterwards the succeeding vapors insipissate the fastened mercury, he becomes too heavy to support himself and runs down, in streaks or veins, to the bottom, until the mercury becomes united with the subtilised fermented gold in the form of a powder.

The small trees grown out of the amalgam, drop down in process of time and become, with the mercury, a red powder.

But before this happens, the upper part of the globe, inside, is beautifully gilt all over.

Amongst all the philosophers, who worked this way, Irenæus Philaletha alone has observed this, which i found exactly true.

### USE OF THE RED POWDER

This red powder must be continued in digestion, increasing now your heat a little, and must be fixed gradually; which requires 3 months time, and an able and patient operator.

This fixed fusible powder or precipitate is called the philosophers gold, because it is prepared in a philosophical manner, by digestion alone.

By the help of this digestion, when finished, you have now completed the true radical and central calcination of gold, and you possess now the genuine calx or ashes of the philosophers, wherein the royal diademe is hidden.

This calx or fixed red powder is the philosophers gold or nearest matter of the Stone, out of which the Great Work may be made, as well as a particular profitable labour.

Now to oblige well intended beginners in this divine art, who wish not only to learn but also to reap an advantage from their labours, I will faithfully communicate, as I have done thus far, not in metaphorical language, but in plain terms, how they may proceed further, and how to work with this calx of gold in a particular way, to enable them to subsist until the great work is accomplished, which I will also faithfully teach hereafter.

### PROCESS IN THE PARTICULAR WAY

You possess now one and a half ounces of philosophical gold; but if you would or could from the beginning work with two glasses, which would be the wisest and safest way, as you can keep one glass with one and a half ounces of sophic mercury, for the universal process, by all means do it.

### AUGMENTATION OF THE SOPHIC GOLD IN QUANTITY

Take your one and a half ounces of philosophical gold, in the same phial it has been fixed in, or put it into another and put it in a sand furnace. Let the sand get pretty hot, so that the phial and the matter may become very hot, so that you can only just bear to touch it.

Then through a well heated glass funnel placed in the mouth of the phial, pour of your prepared sophic mercury half an ounce, previously heated, on your sophic gold in the phial, that is a quarter part of the mercury sophic to three quarters of the calx of gold.

Close the phial with the glass stopper, as there can be no humidity at present. Digest again in a sand heat, your degree of heat must be such, that nothing of the mercury may be sublimed from the calx of gold. Continue to keep your matter in digestion, increasing your heat gently and gradually, during four weeks time and this additional sophic mercury will become fixed by the power of the fixed sophic mercury.

After four weeks time you must increase your heat so as to make the sand almost glowing hot.

(N.B. : The following is an opinion which the translator has here give)

"I presume that this intense heat, which would be perhaps 300 C would cause the subject to melt together into a mass.

It may perhaps be unnecessary, but in order to get the mass out of the phial, it would be necessary to break the globe off; I wish to save the phial, and would rather perform these last three days of Glowing heat in a small crucible, with a lid luted on, to save my phials; I would put the small crucible in another large one filled with sand and covered with sand, and then place the large

crucible in a wind furnace or some other furnace managed with charcoal, and keep the fire just glowing quietly without draught or blast.

I would this way begin and increase my fire gradually."

Your half ounce sophic mercury must not be poured into the phial to the sophic gold, the whole quantity at once, but only gradually, at each time the quantity of the size of a pea, being made warm, as I told you; and after each projection of the mercury into the phial, let the phial stand half an hour in the hot sand, then project again the same small quantity, until the whole half ounce is put in. Then, as has been mentioned, close the phial with the glass stopper and fix the mass, until it melts without fuming.

Now you possess 2 ounces of sophic gold. This is a beginning and a foundation of a minera perpetua at home, which you must still increase in quantity, as you did before, to enable you to take a part of it every month, for reducing it to obtain the emoluments arising therefrom.

## SECOND AUGMENTATION OF THE SOPHIC GOLD IN QUANTITY

It is your interest to multiply this sophic gold in quantity and at least to double it.

The above two ounces imbibe again with half an ounce of new sophic mercury and fix the mass, and in four weeks time you will obtain 2 and a half ounces of sophic or fixed mercurial gold.

In four weeks more you may obtain by the same process, imbibing with half an ounce of animated or sophic mercury, and fix your matter as before, and you will obtain four (4) ounces of sophic gold.

## ITS USE FOR SUPPORT

Of the above six ounces of sophic gold take one and a half ounces. Melt five or six ounces of fine silver in a crucible, project your one and a half ounces of Golden precipitate, enveloped in wax, upon your silver in fusion, and let it melt together for half an hour, the crucible being carefully covered, to prevent any coals from falling in. let it cool, separate the silver from the mass (by aqua fortis) which silver must be previously made into thin lamina in the flattening mill, or filed; if the aqua fortis will not dissolve it, you must melt another ounce of fine silver with it, and you will see a black earth or calx fall out of the solution. Wash and dulcify this calx with water, and melt it with borax, and you will find one and a half ounces of pure fine gold of 24 carat.

The remaining four and a half ounces of golden precipitate divide again in three globe glasses, imbibe each glass with half an ounce of sophic mercury, digest and fix. In this manner you can reduce every month one and a half ounces of sophic gold into corporeal, out of the silver, which at four guineas per ounce amounts to six guineas per month.

(This would answer well enough in Germany but not in England; consider the expenses and time of procuring a sufficient quantity of sophic mercury, the expenses of charcoal and oil for the digestions and fixations and aqua fortis, I believe this work might bear its own expenses but not enable the operator to support himself, therefore it is better to elaborate the tincture at once.)

Therefore we will proceed:

The before mentioned fixed solar precipitate or sophic gold forms a perpetual minera, and is already in this state a most admirable medicine at least equal if not superior to, I.B. Van Helmont's Aurum Horizontale; of this we shall treat further hereafter.

What I have taught you now is a tedious yet a certain and safe particular way to obtain profit every month. But if you like to pursue the same labour further, in order to obtain the universal tincture or stone of the philosophers, which tinges or transmutes all mercurial metallic bodies into genuine gold, you must open your philosophic gold radically and centrally, and subtilise still further, and increase in colour, fusibility and weight; more colour and penetration is obtained from the sophic mercury impregnated or animated by sophic sulfur or fire, and the increase in weight from the external fire.

This further subtilisation is called sublimation or distillation by the philosophers.

**Note 4:** As previously, it is a trap. If borax is not totally eliminated, it will hinder the process.

Ora et Labora!

THE PHILOSOPHERS OF NATURE

Figure enclosed:

- Digestion flask

Figure  
C.80.0890

### DIGESTION FLASK

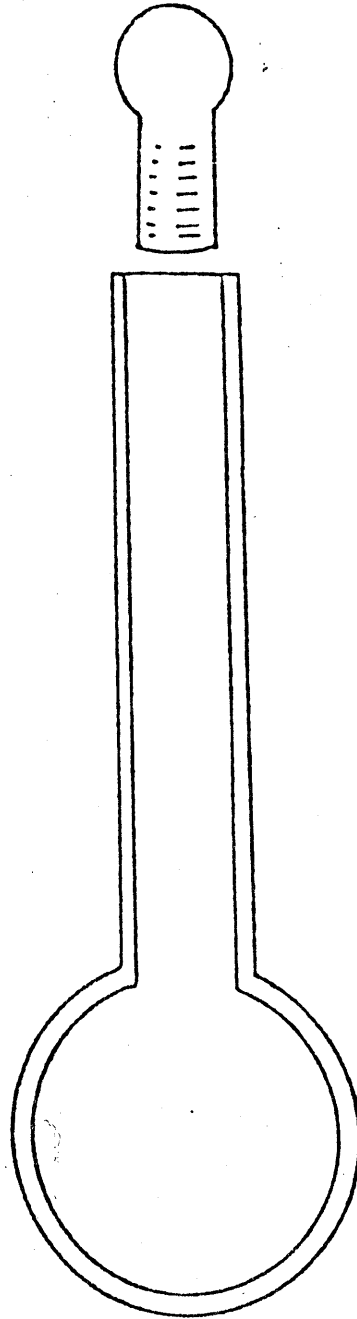

THE PHILOSOPHERS OF NATURE

Copyright © 1989 by LPN-USA

Lesson 81 - MINERAL - page 1

C.81.0990



Venus and Mars enter the fire for the red stage of the work.



Dear Friend,

## COELUM PHILOSOPHORUM (continued)

"Whosoever knows how to tinge sophic mercury with gold or silver possesses the great arcana!"

Note 1: This is the end aphorism of the Coelum Philosophorum.

Hereafter are described the experiments on silver which are in fact several variations for the way of the white stage of the work.

### PROCESS UPON SILVER (CALX OF SILVER)

Take very fine copelled silver, dissolve it in aqua fortis. Weaken the solution with 20 or more parts of clean water. Then pour this diluted solution into a very clean and smooth copper bason, and the calx of silver will settle on the copper all over the bason. Pour more water to it and edulcorate it, until the calx of silver is perfectly tasteless. Then dry it.

### AMALGAMATION WITH MERCURY

Take now of your calx of silver 1 part and amalgamate it with 6 parts of purified running mercury.

Squeeze your amalgam through chamoy leather, to separate the superfluous mercury from it.

The ball remaining in the leather grind with purified dried salt, adding gradually the salt, until you see no more of the amalgam. Put this mixture into a glass retort, which lay deep in sand, and distil the mercury from it into a receiver half full of water, and the silver will remain behind with the salt. Wash the salt from the silver with clean water, and you will obtain a most subtil calx of silver.

Amalgamate this calx of silver once more with purified antimony, and grins the amalgam with purified salt, but grind it as subtil as you can, distil the mercury from it as before, and wash the salt from the remaining silver, until the powder of silver is perfectly tasteless and you will have a subtil calx of silver, which dry.

### PURIFICATION OF THE SALT USED IN THIS PROCESS

Melt 2 or 3 pounds of sea salt in a crucible, dissolve it afterwards in pure water, filter and evaporate the solution until the salt remains perfectly dry.

But if you will take the trouble in the room of loosing this water by evaporating, to distil it from the salt to dryness, you obtained a distilled pure water, which is better for the second solution of this same salt, than other pure water.

The glass body for this distillation must be wide enough to get your hand in it, not too high.

Dissolve your salt now a second time in the above distilled water, filter the solution perfectly clean, and then distil half or  $\frac{2}{3}$  parts of the water from it, until a small skin or film appears on the surface.

Now place it in a cold cellar over night and beautiful salt crystals will shoot, in the form of little pyramids, with 4 sides and hollow within. This is an excellent salt for purposes like this.

Preserve your calx of silver until I tell you what to do with it, in the mean time mind the following process.

Note 2: In this process there is a very important difference with what precedes: the Sophic Mercury is not extracted from the amalgam: it is directly put into digestion. This process takes more time but much easier to realize.

### PROCESS ON SILVER FOR THE STONE

Take fine copelled silver one ounce, martial regulus of antimony one half ounce (or silver two parts, martial regulus one part) melt them together, let it cool and beat the mass to a coarse powder, add 5 ounces running mercury revived from the cinnabar, as I have taught you in the chapter of mercury, amalgamate your coarse powder with this purified mercury with the greatest diligence and in the best manner, then wash your amalgam so often, until no more blackness appear in the water.

Note 3: Recoup the black scorizæ.

Then dry your amalgam and put it into a digestion globe, as I have taught you in the section of gold, no more than 2 ounces in one globe, but less, viz: one and a half ounce is till better.

Let one part in the globe out of three, remain empty.

Shut the neck with a glass stopper, after all the humidity is fairly gone.

Put your globe or globes in a sand heat in a convenient iron athanor, fired with charcoal, and place your globes in a gentle degree of heat at first and the amalgam will rise and go out into little branches like small trees, which in time, by continuing the gentle heat, tumble down again and the whole mass becomes a red powder. The phenomena I observed by this labour are the following:

Note 4: In the original document, the phenomena are not described; here another description of the process begins, which is not much different.

I took two ounces of fine copelled silver, and one part of martial regulus of antimony which I melted together in a crucible. Then I reduced the brittle mass to a coarse powder, and amalgamated my powder with ten parts (10 ounces) of purified mercury with the greatest diligence in my grinding mill, then I washed the amalgam so often, until I could get no more blackness from it.

This amalgam I put by, covered with paper, until it grew of a thick consistence, when I formed it into small pills with clean fingers. These pills I put in china saucers and covered them with paper; then I placed them on a gentle heat to become perfectly dry.

I divided my pills in different digesting globes, putting one and a half ounce of pills in each glass. (The purified mercury amalgamated with the lunar martial regulus of antimony washed and dried, is our animated mercury). The necks of my globes were 8 fingers high and my globes about 2 inches diameter outside. I shut my globes first with paper, in case there should be any humidity left, but when I perceive it is all gone, so that the necks appear perfectly dry, then I put in my glass stoppers quite tight.

I then regulated my heat, having placed my globes in the athanor in sand in such a manner so that the amalgam divided into small pills, moved by the exciting gentle heat, may flow together and ferment, whilst it looks like pitch melting in the sun.

In such a degree of heat, perhaps a little warmer than the beams of the sun, the mass elevated itself like fermenting dough or paste. Part of the mercury was separated and settled within the upper part of the globes, and ran down again within the sides, when the drops became too heavy for their support, leaving intervals or streaks between them, through which I could see how the amalgam behaved, which smelled and grew up from day to day into little trees with their branches.

After 20 days digestion I observed that the points of the branches strait upwards and sideways became of a fine red colour.

One of the center branches in one of the clouds did reach almost the mouth of the neck, most beautiful to look at, stained with red extremities.

I have recovered that some small portion of air is necessary in this work, in the same manner as air is necessary for the alteration and perfection of all creatures.

Such artists as deny all Entrance of air, and order the mouth of the phials to be sealed hermetically, by melting them together, as they do in closing thermometers, deserve to be exposed for their ignorance. Without air there is no action operation in Nature, and without action there is no change, and where there is no change, no amelioration can be expected, but the subject remains as it was in the beginning; and after you have laboured a long time without air and lived in hopes of obtaining something, you at last have to repeat your loss of time and expense, and do you know why? because you have worked without the knowledge of natural things!

In a glass melted together there is not so much temperate air as is necessary, to produce a change on the enclosed matter.

This is a hint to those that study with so much anxiety of mind, how to close their glasses sufficiently, out of fear the generating universal spirit should escape, in spite of wise nature, which produces and multiplies all its creatures by the medium of animated air. But let us return to our process.

**Note 5:** This confirms our theory: if there is no sulfur in the mixture, the oxygen of the air is essential. The Fire present here is the fixed fire of antimony which shall stay in the flask.

After the amalgam was grown upon the glasses, so that it had filled the whole space of the globes, the upper part of the globe became gilt, most beautifully, so that I could no longer see through it.

I let my glasses remain in the sand 2 weeks longer, thinking that this gold color would vanish, but growing out of patience, I took one phial out and examined the mass within, which I found of an unctuous yet porous consistency, and out of curiosity I rubbed it in a glass mortar, and it became a dark brown powder and set forth a smell equal to the finest violets.

Such fools as think that metals are dead bodies, will not believe this. Nevertheless that the central smell of metals and minerals, in particular antimony, is most delightful, is an absolute fact and a proof with me, that they have life and consequently are capable of being exalted.

After having tried this experiment with one phial, I was curious to know whether they were all alike, and found it exactly so, but I did not take the matter out of the phials, I only opened them and found the same smell.

The first which I had ground I put into a clean phial and put it in the sand again in the same degree of heat, but with hopes of success, nevertheless, this powder became fixed as well as the others, therefore the life of metals is of a more durable nature than that of animals and vegetables, and is not so easily destroyed, not even in fusion.

It took then my fixed precipitate out, and whilst it was yet warm, I added to 3 parts of precipitate one part of animated mercury previously warmed. I united them in the phials, that is I poured my warmed animated mercury one part upon 3 parts of my warm red precipitate, into each globe, and set them again in digestion. This mixture united in a moment and became almost instantaneously a dark brown powder; which precipitate by continuing the digestion, became fixed in a few weeks.

Some of these phials I took out and copelled the precipitate, which became most beautiful silver, without scarce any loss in weight.

This silver I separated by aqua fortis, and it contained a good deal of fine gold of 24 carats.

## MULTIPLICATION IN QUANTITY AND QUALITY

If you have a desire to effect an augmentation perpetuum, with this fixed lunar precipitate, you must proceed and augment with our animated mercury exactly in the same manner as I have faithfully told you in the section of gold. But do not be surprised if you find yourself disappointed in your expectations; after having augmented your fixed lunar precipitate with animated mercury 5 or 6 times, you think you will always obtain fine silver enriched with gold, but it is otherwise, and in the room of fine silver you will at last get nothing else but fine gold of 24 carat; because the trifling original quantity of lunar ferment is in time matured and exalted into solar ferment by our animated mercury, which is immature gold, and consequently your lunar ferment as the weakest will easily be overpowered by our gold as the strongest.

**Note 6:** This implies that for the multiplication, the mercury used should be at least a mercury animated by a martial lunar venusian regulus.

This note is also valid for what follows.

Now as from subtilised gold, by repeated radical solutions, a tincture finally must proceed, capable to transmute a great many parts of the inferior metals into permanent gold, exactly in the same manner it happens here with silver, therefore I warn you, that you may not be vexed, when you see your expectations reversed!

## REASONING OF THE AUTHOR

If you want to elaborate a Rx for transmutation into silver, you must observe this: after you have performed the first calcination of silver by animated mercury, that is after you have completed the first solution of the first lunar calx, you must again ferment with fine silver, in order that the specified White Lunar earth, of the so-called sulfur of Luna may not be transmuted or exalted into a solar nature, by several additions or augmentations with animated mercury, whose atoms are entirely solar. This the philosopher ought to know, or he does not know what will be the result of his experiment.

He would sooner obtain a gold than a tincture of silver, as the trifling white sulfurous lunar earth, which is the very specification of silver, transmuting and maturing mercury into silver in the mines, is soon altered and exalted by repeated additions of animated mercury.

You may yourself see the truth of it by the next experiment.

Let him try it that please, if he is not an indolent man and is sincerely desirous of seeing the truth with his own eyes, he will find it here! He will wonder at my sincerity, and thank me after I am no more in this life full of care and toil! I confess, I do admire the wonderful works of God by means of the universal spirit, but I do not worship the stone, being well convinced that I must leave it behind me!

I write the truth, firmly believing that God especially directs these things.

## EXPERIMENT UPON SILVER

Note 7: This experiment is only interesting for the theory; it is useless on the path.

Take one ounce of fine copelled silver, quarter of an ounce of martial regulus stelled melt and reduce to powder, amalgamate your powder with ten ounces of purified mercury revived from cinnabar, wash the amalgam, press the superfluous mercury from the amalgam through thick chamois leather.

The lump remaining in the skin, grind and wash several times, until all the blackness, which is the corporeal regulus, is washed away. Distil your amalgam by retort in a sand heat; if you have proceed rightly, you will find your silver perfectly fine and of the same weight as before. But your mercury, which is come over, above the nature of common gold, becomes a principle capable of making gold.

Thus far I have faithfully taught you how to overcome and exalt gold and silver by running mercury in the Via Sicca Pacifica which is a most ancient way, and although slow, it is safe and without danger.

Now I will teach you Viam humidam which thought somewhat shorter, is slippery and obnoxious on account of the vapors, and also dangerous.

## PROCESS UPON SILVER IN VIA HUMIDA

Note 8: The text about this process is not entirely decoded however it is here a process which uses a mercury which has been revived by the corrosive sublimate. A very difficult and dangerous process.

Make a calx of pure silver, calcined with purified sea salt, by mercury.

When you have made this calx, grind it with three times its own weight of good sublimed mercury, into a subtil powder.

Distil this mixture per retort, and a butter will come over.

What remains behind, weigh exactly, and mix it again with 3 parts of its weight of fresh sublimed mercury, distil again per retort, and all the silver will come over with the butyrum; a few fæces remaining behind.

The mercury contained in the sublimed mercury, must be separated and kept apart.

In this butyrum the silver is dissolved and volatilised by means of the spirits of sea salt and of vitriol, both contained in a highly concentrated State in the sublimed mercury, without the least phlegma.

Both these spirits can effect no such thing upon silver when by themselves, but united to the mercury, in the sublimed mercury, they attack and dissolve the silver, and all metals, volatilise them, and carry them over into the receiver.

The silver can be precipitated out of the distilled solution with water, but here it must not be done:

### FURTHER PROCEDURE WITH YOUR VOLATILISED SILVER AND ITS COAGULATION AND FIXATION

Take the subtilised and volatilised silver, as it is united to the butyrum, put it into a digesting globe with a long neck, coagulate and fix it in a gentle and graduated heat. It tinges tin and lead into silver equal parts.

### THE LAST PROCESS UPON SILVER

Dissolve a marc of fine silver in rectified aqua fortis. This solution pour into a quantity of distilled water. About 10 or 12 times as much water, as you had aqua fortis. Dissolve purified sea salt in distilled rainwater, or filtered water, pour of this salt solution into the solution of silver diluted with water as much as is necessary for precipitating all the silver out of the aqua fortis, which you will perceive, as soon as your solution becomes perfectly clear and does not turn milky from dropping in the salt water.

All the silver falls to the bottom of you bason, like a white most subtil substance.

Pour the salt water carefully from it, and edulcorate your calx of silver several times with distilled water, until it has lost all sharpness, then dry your calx, this sort of calx of silver is called Luna Cornea.

Now take your dried Luna cornea or calx of silver, which by this simple process is very much volatilized, and for that reason has been called by Glauber Mercurius Lunæ, mix it with great diligence with three times as much in weight of purified sal armoniac, put the mixture in a coated glass body, cover it with an alembic, and sublime in a sand heat, and part of your silver will ascend with the sal armoniac. Repeat this sublimation, adding a little new sal armoniac, until all or most of your silver is sublimed and has ascended with the sal armoniac above the caput mortem.

Then take your sublimate out and dissolve it in our circulatum or alkahest (silver and sublimed sal armoniac together).

Distil it over per retort, and the whole will come over like a liquor.

Distil this liquor over a baln. vapor. and the circulatum will come over by it self, and a thick oily liquor will remain behind, containing your sublimed silver.

This liquor you must gradually and carefully unite to rectify S.V., at least 3 parts of S.V. to 1 part of the silver liquor.

Then set it to digestion 24 hours, and distil the S.V. from it in baln. vapo., which will carry over part of the corrosive.

Pour fresh S.V. upon it, digest 24 hours and distil the S.V. from it in balneo vap. as before, and repeat this operation until your silver remains behind like a thick oily liquor perfectly sweet, without the least bitterness or acidity. Great precautions are necessary in the beginning, when you unite the S.V. to the corrosive liquor, it must be done slowly and gradually. See the section of antimony.

The above thick oily liquor of silver is very ponderous, mercurial and volatile. It is by many called sulphur lunæ, although improperly, but let it be so, for the sake of understanding each other.

(A) The remaining earth out of which you have sublimed your silver with sal armoniac, you must place on a broad test, made of bone ashes, and set it in a muffle surrounded not per vapour with burning coals, and calcine it by the flame, gently and regularly during 8 nights and days, then take it out, put it in a glass body, pour well rectified sharp vinegar upon it and extract all what you can in digesting on a gentle heat, during 3 nights and days. (This is not an easy piece of labour).

Pour your clear extraction off, dry the remaining substance, and reverberate or calcine it as before, in the muffle during 8 nights and days, then extract again with fresh distilled vinegar as before. Pour this extraction to the former. You must continue the operation in this manner, until there remains nothing but a dead earth or caput mortem, wherein there is nothing metallic.

This earth proceeds from the aqua fortis and sea salt in the sal armoniac. (I think the sal armoniac should first be washed from the remaining earth).(A) (before it is reverberated in the muffle, the author seems to have forgotten to mention it, if you do not do it, you certainly have it in the vinegar, wherewith you have extracted the fixed salt).

(The above reverberations require an athanor, and are difficult and tedious operations).

Put your solutions all together into a glass body and distil the vinegar ever gently, and there remains a saline massa, which is improperly called Sal Lunæ. It is a part of the subtilised silver. But let it be called so.

This saline massa must be purified by solutions, filtrations and evaporations until the salt is clear and white. Distilled rain water is proper to purify this.

Note 9: The entire first part is useless because it leads to a silver chloride. This chloride can be obtained by dissolving silver nitrate in water saturated with purified sea salt. The silver chloride decomposes when exposed to light.

## COMPOSITION



Take your purified fixed salt as much as there is of it, weigh it, let it be perfectly dry, grind it in a glass or porphyry mortar with half its weight of our animated mercury, and put the mixture in a digesting globe, place it in a very gentle heat and let it stand until it is become a grey powder.

Now divide your dulcified oil of silver in 3 equal parts. Take one part and warm it a little, and pour it into the phial upon your grey powder, digest again and it will coagulate and become a powder.

Pour the second part of your oleum lunæ upon this powder, digest again until it is become a powder.

With the third and last part proceed exactly in the same manner.

Then let it stand a few weeks longer, increasing your gentle heat gradually, in order to fix your powder thoroughly.

If it flows immediately on a red hot copper plate, without the least smoke, it is right. If not, it must stand longer in the hot sand. This Rx. transmutes copper, tin, lead and mercury into fine silver. One part: 50 parts the first time.

### MULTIPLICATION

Prepare some more oleum lunæ, as I have taught in this process, dissolve your fixed medicine therein, or imbibe your RX. therewith, coagulate and fix it; if you repeat this 6 or 7 times or still oftener, you may multiply this metallic medicine so highly, as to tinge several 1000 parts; because the oftener the Rx. is dissolved and coagulated and fixed, the more it becomes subtil, ingressive and penetrating and so it is with all metallic tinctures. This much of silver.

Ora et Labora!

THE PHILOSOPHERS OF NATURE

THE PHILOSOPHERS OF NATURE

Copyright © 1989 by LPN-USA

Lesson 82 - MINERAL - page 1

C.82.1090



In Urbigerus' third way, the way of the rich, the amalgam is seeded with ordinary gold.

Dear Friend,

## COELUM PHILOSOPHORUM (continued)

**Note 1:** This chapter "OF MERCURY", is not usable directly in the form described in Coelum Philosophorum. The operations have been mixed up; there is intentional confusion, for instance, between sublimed mercury and sublimed corrosive mercury. However, it contains an essential teaching in order to manipulate mercury.

### OF MERCURY

Est in Mercurio quidquid quaerunt Sapientes! (All that which the sages are looking for can be found in mercury!)

This subject is in truth a subject of all wonder. It is a water and does not wet. it is an earth yet it is volatile. It is a spirit, and yet after gold it is the heaviest thing in Nature.

It is a body and yet penetrates all things. Mercury is a homogenous as gold itself, and it is the water, out of which all metals have their origin. With truth mercury may be called unripe gold, because by bare digestion and animation it may be fixed into gold.

If you want to obtain any good from mercury you must coagulate and fix him, either by the power of his own internal sulfur or by addition of another sulfur.

This appears in common cinnabar and cinnabar of antimony, where we observe that the mercury, although only coagulated by common sulfur, has great virtue in medicine, and in alchemy gives proofs that he is an unripe gold. If you cement fine laminated silver with common cinnabar and melt and separate it by aqua fortis, you will, after every cementation, obtain a few grains of pure gold.

**Note 2:** The corrosive sublimate which is a chloride of mercury is an extremely toxic poison.

### THE TRUE METHOD TO SUBLIME SUBLIMED MERCURY FROM CORROSIVE MERCURY

As this is very necessary in alchemy, I'll teach you the best method to make it.

Take one pound of running mercury: dissolve it in a sufficient quantity of good aqua fortis: put in the solution gradually 2 lb of good common salt or sea salt.

Pour this mixed solution into a strong coated glass body: apply an alembic and lute a receiver to it, placing your glass body pretty deep in a sand pot, in a charcoal furnace. Then distil with a gentle heat, no more than is necessary to distil the aqua fortis over into the receiver: after 3 or 4 hours time, when most of it is come over, increase your heat, to force over, the blood red

vapours or anima nitri contained in the aqua fortis. When all is come over you have an excellent aqua regia.

Now you must increase your fire still more until you see the mercury ascending and subliming above the salt.

The highest and most subtil flowers keep apart, as they are very useful for making our ciculatum.

That part of the sublimate which is solid, put into a smaller subliming body, in fine powder, and sublime it once more, by itself.

**Note 3:** Modern method to make corrosive sublimate:

Dissolve mercury in sulfuric acid with an excess of acid. When all the mercury has been dissolved, the excess acid is evaporated (difficult and dangerous stage of the operation). We have then obtained a sulfate of mercury.

The sulfate of mercury is mixed with dry sodium chloride (in our case purified sea salt) 4 parts of sulfate, one part of chloride. Add some manganese bioxide. From 295 C, the sublimate deposits on the top of the flask. The sublimate melts at 265 C. It is soluble in the following ratio: 65 grams per one liter of water at a temperature of 10 C and 500 gram at 100 C.

The corrosive sublimate is also known as mercury bichloride.

## THE MAKING OF CINNABAR

Take running mercury 2 parts and pure common sulfur 1 part, melt the sulfur on a small heat, pour the mercury into the melted sulfur and stir it quickly, until you see no more mercury and you will obtain a black mass, called Aethiops Mineralis.

When cold, grind it to powder and mix it with half its weight of common very dry kitchen salt: put the mixture into a subliming body, which place in hot sand, cover it with a lid or piece of tile and increase your fire gradually, and the mercury will ascend in the form of cinnabar and carry as much sulfur with him as he needs for his coagulation and leave the impurities in the bottom with the salt.

**Note 4:** The cinnabar is not interesting for the purification of mercury. Distillation is a simpler method. That process is interesting to make an animated cinnabar. You must use some purified sulfur proceeding from volcanic earth with sophic mercury and set to digest.

## THE MAKING OF CINNABAR OF ANTIMONY

**Note 5:** In the following text, the first part is the making of antimony butter; we prefer the method already given in the lessons.

The mercury obtained in this operation is a mercury revived by the antimony and the sea salt.

Crude antimony is stibnite separated from its gangue; reduce it to powder in an air tight container.

Take 2 pounds of crude antimony, pound it in an iron mortar until it is a subtil powder and sift it; take 4 pounds of sublimed mercury and reduce it to a subtil powder: beware of the dust. Mix both pouders and put them into a glass coated retort, which place very deep in sand and cover the retort with the sand as much as possible, then distil by a well regulated, gradually increasing heat, until all the butyrum is come over into the receiver, which must be luted on, as the vapours if received into the lungs are mortal on the spot; the neck of the retort must be wide and short, that the whole retort may get very hot, else the butyrum would coagulate in the neck. (Confirmed by the great Boerhaave).

In order to obtain the cinnabar, you must increase your heat very much, so that the sand in the bottom as well as the bottom of the iron sand pot may become glowing or red hot. Then the sulfur of antimony laying hold of the running mercury left behind from the sublimed mercury, sublimes itself within the upper part of the retort and is called cinnabar of antimony. By means of a glass retort you can observe when the sublimation is ended, otherwise earthen retorts are commonly used. When the sublimation is ended let the fire gradually die away.

If you coat the bottom of the retort with a strong lutum of crucible clay, you may lay your glass retort over a naked charcoal fire, after the butyrum is come over in a sand heat, and the sublimation will be done quicker and equally safe. This last is my method.

### COAGULATION OF MERCURY BY MEANS OF ITS OWN INTERNAL SULFUR

Take mercury revived from cinnabar q.v. animate it with the stellated martial regulus of antimony as I have taught you, in the section of gold.

Take of that mercury q.v. and put it in a convenient glass retort, adapt a receiver with water, place the retort in a sand heat, and distil the mercury over with a gentle heat, slowly.

A red powder will remain at the bottom in the retort but not much. Observe, if you give so strong a fire, as to make the iron pot and the sand glow, your red powder will melt and become gold. But this is not the intention.

Take your mercury and dry it, and pour it back upon the red powder into the retort and distil the mercury over as before, and your red powder will increase in quantity at each distillation.

Continue this operation until the whole quantity of animated mercury is become red powder. It is true that this requires time and patience, nevertheless if you have convenient vessels, in two months time, at least one ounce of such red gold may very easily be obtained. Or:

Take small phials with long necks. Pour in each phial only half an ounce of animated mercury: place the phials in a row in a sand heat in an athanor, which is fired with charcoal and keeps its heat at least 24 hours.

Place the phials in such a degree of heat that the mercury can sublime and settle in the upper part and necks of the phials.

The necks must stand in the open air, covered only with writing paper, but the globes must be buried in the sand.

After all humidity is gone, you must put a wooden stopper in each phial, which must go in easy.

If you find now the mercury ascending gently and settling in the neck, your degree is right. Then with a clean hair pencil, you sweep the mercury down into the globe; and do this as often as you have such a sublimation and settling of the animated mercury.

In 2 months time, and sometimes sooner, you will have your animated mercury in every globe converted into a red shining solar precipitate. By this method, suppose you work with 12 glasses, you may obtain 6 ounces of sophic gold.

Divide this now in phials, as I have taught in the first section of gold, and fix it by degrees of gentle heat, and you have made out of sophic mercury a sophic gold, which is the beginning and basis of our great work.

N.B. A sophic gold, where the centre is turned outwards, is MATERIA PROXIMA LAPIDUS and must be treated as I have faithfully taught you in the section of gold.

N.B. In the state wherein this gold is, it would be a sin to melt it, because then you would obtain common gold only -- gold without any power. Therefore this sophic mercury must be dissolved with fresh animated mercury and fixed, and this operation must be repeated, until your fixed powder is become of the easiest fusion, penetrating and tinging.

**OUR MENSTRUUM CORROSIVUM SPECIFICUM  
or CIRCULATUM  
or ALCAHEST**

**Note 6:** We are now going to give the making of these circulata or alcahest with 3 different methods. They are complex mixtures but we can say that the basis is aqua regia to which corrosive sublimate or antimony butter has been added or both. Often quoted in the work, in one name or another, it is best to use one way that does not require their use, their preparation being eminently difficult and dangerous.

Take: Calcined vitriol (copper sulfate)	: 4 pounds
Calcined alum	: 2 pounds

Niter	: 3 pounds
Common salt	: 1 pound
Sal ammoniac	: half a pound

Powder each ingredient separately, then mix in the stone mortar.

Take calcined and extinguished (brittle) flints reduced to powder 6 pounds and mix with the above ingredients, now you have 16 1/2 pounds.

Divide it in 3 or 4 parts, and put each quantity into a well baked earthen retort, fixed in a furnace; there is not so much danger in this process as in the former, as the niter is so much weakened by the other ingredients.

Give first a gentle fire and increase it to a strong heat gradually, until all the spirits which come over in vapours, are driven into the receiver, which must be large and luted to the retort as before directed.

You keep up your fire until all the spirits are come over, but as soon as the receiver is clear, and the spirits are settled, let the fire go out.

When the spirits are well settled, take the receiver away and pour the aqua fortis into a large glass bottle stopped with a glass stopper.

Now take all your caput mortem out of the retorts, reduce them to powder and pour clean water upon them and boil the salt out of them. This must be done in a strong glazed earthen vessel.

Filter the lye and evaporate in a glazed pan, until a skin appears on the superficies, then pour it on flat glazed earthen dishes, and set them in a cold place, and the salt will shoot into crystals.

Pour the liquor off and dry the salt crystals. Weigh them and add as much sublimed mercury, and flowers or sublimed sal ammoniac; the meaning is to take 4 ounces of each; pound and mix these 3 things with great care, as the dust is dangerous if breathed into the lungs, dissolve this mixed powders in your former spirit or aqua fortis; this done you must add gradually and cautiously 8 ounces of well rectified butyrum made of martial regulus of antimony and sublimed mercury; observe what we said before. (If you obtain more than 4 ounces of fixed salts them you must take in equal parts).

Digest over the lamp, and then put your spirit in a glass body, luting an alembic over the body, and into a receiver to the pipe of the alembic.

Or put the digested spirit into a capacious retort and distil, increasing your heat gradually; the retort must stand in a sand pot, fixed in a charcoal furnace.

The spirits will come over as red as blood. Pour your spirit back on the caput mortem, which is the salt, and distil again; continue this cohobation and distillation, until all the salt is

come over with the spirit, leaving a tasteless earth or earthy fæces behind, which are of no further use.

Dephlegmate this spirit in balneo vaporis and if you have well rectified it from its earthly fæces, you have then in your possession a menstruum which does dissolve and volatilise the calxes of metals. It volatilises the calxes of gold and silver, so that they may be easily reduced into a mercury of the gold or silver. (Virtue and use).

The calxes of the inferior metals it divides into a mercurial and terrestrial part, as I mean to demonstrate to you in the chapter of antimony.

As this menstruum is frequently mentioned in my treatise in the destruction and amelioration of the metals, I call it circulatum in order when in the Sequel I come to mention it, that you may know I mean this solvent.

#### TO PREPARE THE SAME MENSTRUUM BY A SOMEWHAT DIFFERENT PROCESS. N.B.

Take the before mentioned ingredients finely powdered and well mixed. Divide the whole quantity into 3 equal parts.

Force all the spirits out of the first part or quantity. Then pour your distilled spirit on the second quantity put into another retort, and distil the spirit over as before. This second spirit pour on the third quantity of ingredients into a new retort, and distil the spirit over the third time, as you have done before, every time towards the end of the distillation increase you fire to a very strong heat, in order to force all over what will go.

Then take 3 caput mortems (spirits in Dubuis' text) out of the retorts, boil the fixed gold out of them with water, filter the lye, evaporate and let it shoot into gold (crystals in Dubuis' text).

This salt must be dissolved in the spirit, distil the spirit over out of glass retort placed in sand, and cohobate the spirit so often, distilling it over every time, until all the salt, except a few earthly fæces, is come over with the spirit, which is a red liquor. Dephlegmate and rectify it per se. It shines in darkness as a burning charcoal and can be coagulated and fixated into a ruby red stone, which unites with gold in the crucible. (The last sentence appears only in Dubuis' text)

#### MENSTRUUM FOR THE SOLUTION OF GOLD PROCEEDING FROM SAL AMMONIAC, NITER AND BUTYRUM ANTIMONII

Take purified sal ammoniac 3 pounds, good purified niter 3 pounds, reduce them separately to powder and mix these ingredients with 6 pounds calcined flints reduced to powder, or fine colus, it is the same.



Lay a tubulated earthen retort in a furnace, on two iron bars, so that the flame can play all round the bottom of the retort, adapt a very large receiver and lute it together with stripes of linnen and paste.

When the luting is perfectly dry, light your fire under the retort, but let it be very small and gentle at first to heat the vessels gradually, leaving the stopper of the retort open, in order that the heated earth may escape. Do not let the bottom of the retort become red hot yet. Your fire must be moderate in the beginning.

Put now 2 ounces of the mixture into the retort, by means of a funnel, covering the whole quantity with the stopper, and a piece of warm soft clay or loam on the top of it; because the stoppers in earthen retort never fir air tight.

Spirits will now come over in white clouds. As soon as you see that the vapours have settled, project again a couple of ounces of the mixture into the retort as before.

If you find that the white clouds will not come over into the receiver, your fire is then too gentle and you must put in a few more coals until you see the vapours come over; but if they come over with too much violence, so as to endanger the bursting of the balloon, the fire is too strong, and you must take some coals out immediately, therefore the furnace must have a door in front, beside the door of the ash or draught hole. Continue projecting the mixture gradually into the retort until all is used and the spirits come over. The bottom of the retort will at last become red hot, but then you must project less of the mixture into the retort, to avoid the danger of a sudden fulmination, which might blow up the whole apparatus; with care it can be done with perfect safety.

Let the fire go out and die away gradually. The next day, pour your spirit out, into a large glass bottle with a glass stopper.

Take one pound of this spirit, put it into a large glass receiver, or into a large glass body, drop into it gradually with great caution 2 ounces butyrum of antimony well rectified and made fluid by liquefaction on the air, the glass will become very hot, and it will run over, if you go on too fast.

After the butyrum is dissolved in the spirit, and the effervescence has ceased, drop in 2 ounces more, and so continue gradually, until 8 ounces of butyrum of antimony have been united to one pound of your first made spirit.

When all is quiet and perfectly united, pour the mixture into a low roomy glass body, apply an alembic, and lute a receiver to the bill or tube of the alembic. Your body must be placed in a heat furnace. Light your fire and raise your heat gently and gradually, until you see what degree the subject requires and a combined spirit will come over into the receiver.

The fæces throw away.

This spirit dissolves any calx of gold radically, volatilizes the same in such a manner that you may distil your gold over per retort; which gold you may afterwards fix, and multiply per tincturam of iron, of copper and of antimony.

## OF SALT COMMUNE AND THE CIRCULATUM MINUS OF PARACELSUS

Sea salt or common salt is of great use in alchemy. It must be purified by melting, dissolving, filtering, and coagulating.

After you have purified 3 or 4 pounds of it, mix it, one part of salt with 3 parts of loam, form little balls thereof like small marbles, dry them thoroughly.

Fill half an earth retort with these balls, lay the retort over a naked fire in a furnace, which heat gradually, until the retort becomes red hot at the bottom and the spirits come over into a large receiver luted on.

When you have distilled all the spirit in this manner, let the fire go out, and dephlegmate your spirit per alembicum in a balneum vaporis.

Now take 1/2 pound of fresh salt perfectly dry, dissolve it in one pound of your spirit, put it in a glass retort, which lay deep in sand, adapt a large receiver and lute the joinings.

Distil now your spirit, put it in a glass retort, which lay deep in sand, adapt a large receiver and lute the joinings.

Distil now your spirit over by a graduated and strong heat, and the spirit will carry part of your dissolved salt over. When all the spirit is come over, pour it back the next day on the caput mortem of salt in the retort, and distil again in the same manner as before, always giving a strong heat at the latter part of the distillation. Cohobate your spirit in this manner upon your salt, until all your salt in the retort is become spirit.

This spirit must again be dephlegmated in balneum vaporosum, where the phlegma comes over and leaves a gold coloured spirit of salt behind in the glass body.

This gold coloured spirit of salt is the circulatum minus of Paracelsus, wherewith all the metals can be conquered.

If you have our circulatum or Alcahest you do not want the above.

## OUR CORROSIVE MENSTRUUM OR AQUA REGIA WHEREIN WE DISSOLVE AND VOLATILISE THE GOLD

Take sal ammoniac, niter and calcined alum in equal parts, 5 pounds, i.e. 15 pounds together. Rub each ingredient to a fine powder, then mix them well in the mortar.

Further take flints 15 or 166 pounds previously calcined and extinguished in cold water until they become brittle; reduce them into a powder like meal, mix this powder, whereof you must have 15 pounds, gradually and exactly with the above ingredients.

This must be distilled out of a stone tubulated retort, in the manner as follows:

### ITS DISTILLATION

Take a good large earthen retort, which fix in a brick furnace so that the flame by the draught of the fire and air, may be able to circulate under and all around the retort, so as to bring it gradually to a red heat.

When your retort is thus disposed in the furnace, so as to receive the bare flame, adapt a large tubulated receiver; and lute the joinings with linnen and paste. let the luting get perfectly dry. Then light your fire and increase it gradually, until the retort is of a red heat at the bottom and sides, but not where it reaches above or out of the furnace.

When you have obtained this, keep your fire so. Now take your powdered ingredients dried thoroughly and heated in a bason, if there is any humidity in them or if they are not well heated, the retort flies in a thousand pieces.

Take small iron ladle, warmed, and project half a ladle full or at most 1 ounce of the heated ingredients through a thin funnel, into the tubulated retort, put in the stone stopper immediately and a piece of warm soft clay (Windsor loam) on the top of the stopper.

As soon as this small quantity of the mixture is thrown into the retort, the niter melts and fulminates with the sal ammoniac, but the calcined salt and the calcined flint powder hinders this fulmen in a great measure, otherwise it could not be done at all.

As soon as the retort is stopped white fumes come over, which fill the receiver immediately (the receiver must be very large and have a tube and stopper in the belly; in this tube you may put a cork, with a goose quill or small glass tube passed through the cork, that you may have it in your power, to let out some of the elastic air contained in the niter, to prevent the balloon from bursting, which corrosive vapours would suffocate the operator; it is a dangerous unpleasant operation!). (It would be still safer to join 2 balloons one into the other and so have a vent hole in the stopper of the second receiver).

(It is the sal ammoniac that causes the niter to do mischief).

Keep your fire very steady, do not increase it, and wait now until the receiver or receivers grow clear again and the fumes are settled.

(The receivers must be kept cool, with a towel dipped in cold water). Now project again the same small quantity, half a small iron ladle full, and do as before. In this manner you must continue until the whole quantity is distilled, which is long, tedious and dangerous operation. In my own aqua fortis furnace it can be done without danger; whereof I have given you a draught. (This draught is not in my book).

When you have thus obtained the spirits, and after they have settled in the balloon, or receiver, unlute your vessels carefully.

Then pour your aqua regia into a large roomy glass.

### FURTHER PROCEDURE WITH THIS AQUA REGIA

Weigh 1 pound of your aqua regia and pour it into a large glass body, drop into it a little at a time, 2 ounces butyrum made of martial regulus of antimony and sublimed mercury; it causes a great effervescence, which makes the glass very hot and would break the glass if the 2 ounces of butyrum were poured into the aqua regia all at once.

Therefore every time you pour in a small quantity you must wait, until the effervescence has ceased, and so you may do it safely.

The aqua regia becomes as red as blood by the union with the butyrum.

When they are united and the conflict has subsided, pour the mixture into a roomy tubulated retort of glass, which place in a sand heat, and with gentle fire distil the menstruum over in a capacious receiver, lute on.

The menstruum comes over clear like water, and orange coloured fæces, proceeding from the regulus remain behind in the retort.

Rectify the Menstruum once or twice by retort and gentle heat, until there remain no fæces behind.

If you perceive phlegma in it, you must distil the phlegma from it per alembicum over a balneo vaporis; the phlegma being lighter than the spirit, forsakes the spirit and comes over first.

This is our corrosive menstruum to dissolve the flowers of gold, and to volatilise them, and distil them over per retort.

(This solvent was invented and described by Basilius Valentinus in the 14th century).

(I think this same menstruum might be made in a much more safe way. i would take all the ingredients except the sal ammoniac and distil my spirit of niter in the usual way. Then dissolve (cold) gradually by little and little my sal ammoniac in the spirit of niter; then rectify this aqua regia until there remain no fæces; then unite to 1 lb of this spirit 2 ounces of butyrum as the author teaches, rectify 2 or 3 times my combined spirit and dephlegmate it if necessary, and I should obtain the same corrosive menstruum with infinitely less trouble and danger, and in a shorter time. S.B.).

### PROCESS TO ELABORATE THE WHITE AND RED MEDICINES VIA UNIVERSALIS

Take now of your sophic golden precipitate 1 part, and mercury sophic 2 parts. Or sophic gold 1/2 ounce and mercury sophic 1 ounce; amalgamate them as follows: put your sophic powder

of gold in one of your clean small digesting globes and pour your sophic mercury thereon, all at once; let the humidity exhale first in the sun or in a gentle heat. Put on the glass stopper; place your globe in a gentle warmth in your furnace, and it will amalgamate itself, the gold powder will insinuate itself into the mercury and will radically mix therewith; as soon as this is accomplished, which you will easily perceive, then open the phial and pour the amalgam into a clean warmed glass mortar, grind it well with a gentle motion, and pour warm clean water on it, grinding a little more, let it settle and pour the water off again; repeat this 2 or 3 times more, if you perceive any colour yet in the water.

As soon as the water comes off perfectly clear and transparent, dry your amalgam in the sun, or on a very gentle heat.

Now put your dry amalgam again in the digesting globe and place it in warm ashes or sand, in your digesting furnace over a lamp, cover the phial with paper during the first 24 hours, if you presume any humidity in the amalgam, if not shut the phial close with its glass stopper, and observe to regulate your heat as I tell you:

This heat in the beginning must not be greater than the heat of the sun in the middle of summer, from 90 to 100. (The degree of hatching eggs is about 96).

Let it stand quiet, do not move it, and the composition will ferment and turn as black as ink, and look like melted pitch, throwing up small bladders or bubbles from time to time.

(Iren. Philal.)

In this regimen of Saturn the operator must not increase his heat, that the mercury may not forsake the gold. You must prevent the mercury from circulating, during 40 or 50 days you must have plenty of patience and wait until the blackness disappears entirely.

Continue your gentle degree of blood warm, and the mercury will of itself begin to circulate, and gently ascend and descend again, until after several months circulation the whole mass becomes a beautiful white powder.

This white powder is the white sulfur of the philosophers.

This sulfur does not tinge, and cannot be exalted alone without imbibition, on account of its fixed nature.

Philaletha mentions that this white sulfur can not be exalted per se, and then adds a plain sophistry, repenting perhaps of having said too much, that this sulfur would begin again to circulate, which is against all reason. Then he says again that this sulfur must be imbibed or fed with the spirit of life.

It is obvious and experience has taught me to imbibe this white sulfur with the spirit of life, i.e. with animated or sophic mercury, which dissolves the sulfur, then it must be circulated and exalted, as I shall faithfully teach you.

## FURTHER PROCEDURE WITH THE WHITE SULFUR AD TINCTURAM ALBAM

Take 2 ounces of fine copelled silver, let it melt in a new crucible, project 1 ounce of your white sulfur enveloped in wax on your silver in fusion, and let it flow 1/2 an hour, cover the crucible that no coals may fall into it, and you will obtain a white vitreous mass which is brittle; rub it to a subtil powder; take one part of this powder or 1/2 ounce and put it in a digesting globe, pour on it 2 parts or 1 ounce of sophic mercury; if there is no humidity in it, shut your glass with the glass stopper, and set it in the digesting furnace in a gentle heat as before, and the sophic mercury will dissolve the mass gradually and become black with the mass and at last become a white powder in a much shorter time than before.

This is the white elixir in a state of infancy, and tinges metals into fine silver, although in a small quantity only.

### MULTIPLICATION OF THE WHITE ELIXIR

In order to make it tinge more, it must be further subtilised and made more fusible and penetrating; this is done if you imbibe this medicine 3 or 4 times more with sophic mercury and fix it every time.

You have now 1 1/2 ounces of white medicine into a digesting globe, so that only 1/3 part is filled, add to it 1/2 ounce of your sophic mercury, set it in digestion in a gentle heat, as before, and in 8 days time, the sophic mercury will be imbibed, and dried up with the mass.

Add again 1/2 an ounce of sophic mercury, digest as before during 8 days and nights, and the mercury is again dried up, and repeat this a third time, adding 1/2 an ounce of new sophic mercury.

The 4th, 5th and 6th time imbibe your medicine each time with one ounce of sophic mercury, digest and dry up each time.

The seventh and last time imbibe this whole quantity of medicine placed in a digesting globe of a large capacity with 2 1/2 ounces of sophic mercury, digest as before, and after a short blackness the whole composition will become a brilliant white powder and elixir, which is the multiplied tincture for the white.

This must be melted again with fine silver in the crucible, 1 part with 2 or 3 parts of fine silver, and you will again obtain a vitreous brittle mass.

This vitreous substance can be multiplied ad infinitum. With this you may make projection on the inferior mercuric metals, such as lead, tin, and mercury to transmute them into the finest silver.

## PROCESS WITH THE WHITE SULFUR TO MAKE THE RED MEDICINE THEREOF

Take the white sulfur, whilst it is yet warm, imbibe it 2 or 3 times with sophic mercury, until it is become a soft and somewhat dark mass, then shut the glass and digest, during the first 30 days the dark colour will disappear, continue the digestion and during the second thirty days the mass will become green and of various colours, afterwards yellow and if you continue the digestion it will become at last a deep red powder. (Sulfur rubrum). This red powder is the red sulfur of the philosophers.

Take the above red sulfur 1 part and 2 or 3 parts of pure gold, melt it together as you did before when you melted the white sulfur with fine silver; and you will obtain a vitrious mass, which reduce to a subtil powder.

Imbibe the this powder with mercury sophic in the same manner as you did with the white sulfur or white tincture; digest and fix it again; this must be repeated several times, imbibing the medicine, digesting and fixing it; and you will accomplish the red stone for metals.

## OF PROJECTION WITH THE RED STONE

Take 3, 4 or 5 parts of fine gold (the quantity of gold depends upon the power of the augmented or multiplied medicine) let it flow in a new clean crucible and project one part of your multiplied medicine, let them melt and unite well together until you have obtained a deep red, brittle, opaque, vitreous mass; which when cold, beat to powder.

With this red very poudorous powder you can make projection on mercury and all other inferior metals.

The power or virtue of the medicine depends upon the multiplication, consequently how many hundred or thousand parts 1 part tinges, must be found out be a few experiments.

If the transmuted metal is brittle; and if the whole quantity of metal is not transmuted, it is a sign that you have not taken enough of the medicine.

## MULTIPLICATION

Concerning the multiplication of the medicine, I will only add, that the multiplication is nothing more than a repetition of the work.

I take of the medicine either white or red 1 part and 2 parts fine silver or fine gold, and melt it well together in a crucible.

Then I amalgamate the powder with mercury sopic, dissolve it in a gentle digestion and fix it; and in a short time the labour is accomplished, and the tincture is multiplied in virtue and quantity; whereof several authors, principally Irenæus Philaletha and d'Espagnet have written very candidly, yet with some distinction.

Ora et Labora!

THE PHILOSOPHERS OF NATURE





THE PHILOSOPHERS OF NATURE

Copyright © 1989 by LPN-USA

Lesson 83 - MINERAL - page 1

C.83.1190

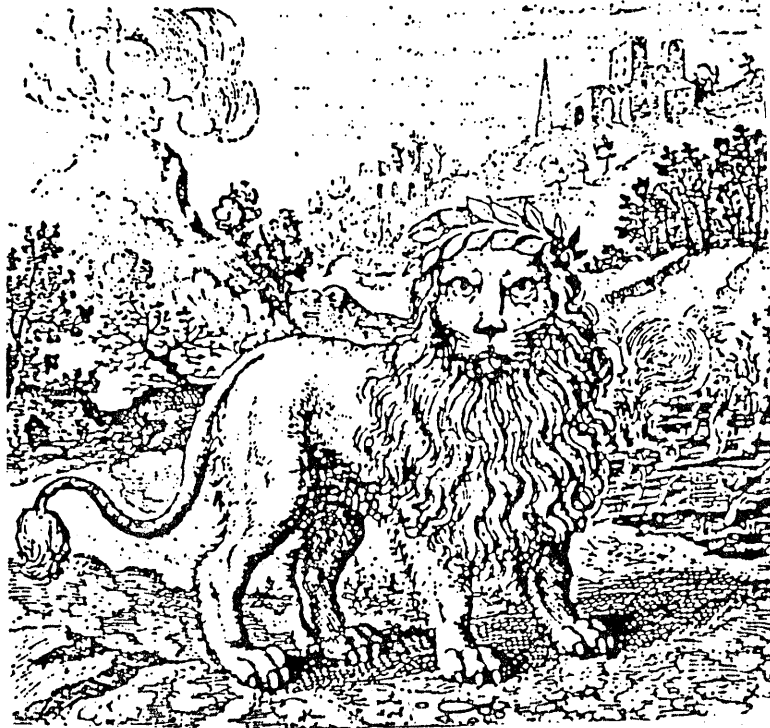

The red lion wakes up.

Dear Friend,

We said that a metal could evolve if it had the means to, i.e. if it can get rid of its poisons, be fed with metallic oxygen: sulfur.

On the other hand, if at this first stage we add Fire then the seed the metal will quickly reach the top of the evolution of the metallic realm and even go beyond it. At that moment, we have a regenerated metal, initiated metal, the cubic stone of the philosophers.

## COELUM PHILOSOPHORUM (continued)

### SECOND SECTION OF GOLD

We have faithfully communicated how gold may be exalted and made useful that is tinging by the Via Sicca in the particular and Universal Way, which an intelligent operator will receive thankfully and will find that we have not told him fables and impossibilities, but the plain and honest truth, which by prudent assiduity and not very laborious application may with the blessing of God be easily accomplished.

Now I will teach you how gold can be opened and exalted via humida, which is a process denied and contradicted by many, but I am certain that such a contradiction is not founded in experience.

True it is, that the ancient Philosophers have not known corrosive solvents, and those that followed them in metallic labours in via sicca, have adopted the mercury as the only metallic solvent and believed no other, contradicting every other method, and more so, they saw, that some who worked not with mercury, failed and missed their aim; but that does not prove the impossibility of success by corrosives; nor does it from thence follow that one man or some men can know every thing, and that what they are ignorant of or deny should be absolutely false; but the truth is that we ought to say with a certain wise man:

Heu quantum est quod nescimus! (O how many things are there, which we do not know!)

Therefore let no man be persuaded to abstain from metallic labours in via humida, but act with prudence, and aim at nothing else but at a subtilisation and exaltation of the metals, and remember that although the corrosive solvents are not of a metallic nature and have no essential ingress in the central mixture of metals, yet they can be used as instruments and a medium, which after they have served the operator, may be very soon separated from the metallic homogeneity, which must be done. (Paracelsus and Hollandus worked constantly with corrosives, so does Basilius and others).

## PROCESS WITH GOLD IN VIA HUMIDA

Take very pure gold, make it into a subtil calx, as follows:

Take sublimed mercury, which has been made by aqua fortis and niter, sublime this mercury 7 times, as will be taught in the chapter of mercury.

Of this sublimed mercury take 6 ounces, break it in pieces, the size of a hazelnut, put these pieces into a glass retort with a wide neck; put upon it the following mixture.

Take of pure gold  $\frac{1}{2}$  an ounce, zinc one and a half ounce, melt this together in a crucible, and pour it out in a flat heated [ plate of iron, when it is cold break it in pieces; these pieces lay on the sublimed mercury in the retort, which must be tubulated; place the retort in a sand pot made of iron, adapt a receiver, but lute nothing; the retort must have a baked earthen cover, to keep the heat in the better.

Increase your fire gradually, at last pretty strong, and the sublimed mercury will come over with the zinc in form of an oil or butyrum, and at last follows the fluid mercury.

(The concentrated spirit of sea salt in the sublimed mercury lays hold of the zinc and carries it over as a butyrum, the fluid mercury thus left alone with the gold, forsakes the gold and comes over as running mercury). But the gold remains in the retort like an opened calx without splendor, partly in the neck near the body and partly in the bottom of the retort.

The retort must be made in the following manner:

- A. The bottom of the retort.
- B. The upper part of the retort, which fits over the lower part, and must be luted on.
- C. A cover made of clay and well baked to keep the heat all over the retort.
- D. The sand pot is made of iron.
- E. Upper door in the furnace; fixed with charcoal.

The double retort must be made pretty strong of good glass.]

This requires a strong and well regulated heat; if you work right, the whole quantity of gold ascends in subtil flowers into the neck of the double retort (See figure). But the sublimed mercury goes over first with the zinc as a butyrum.

You may take martial regulus of antimony in the room of zinc, in the following manner:

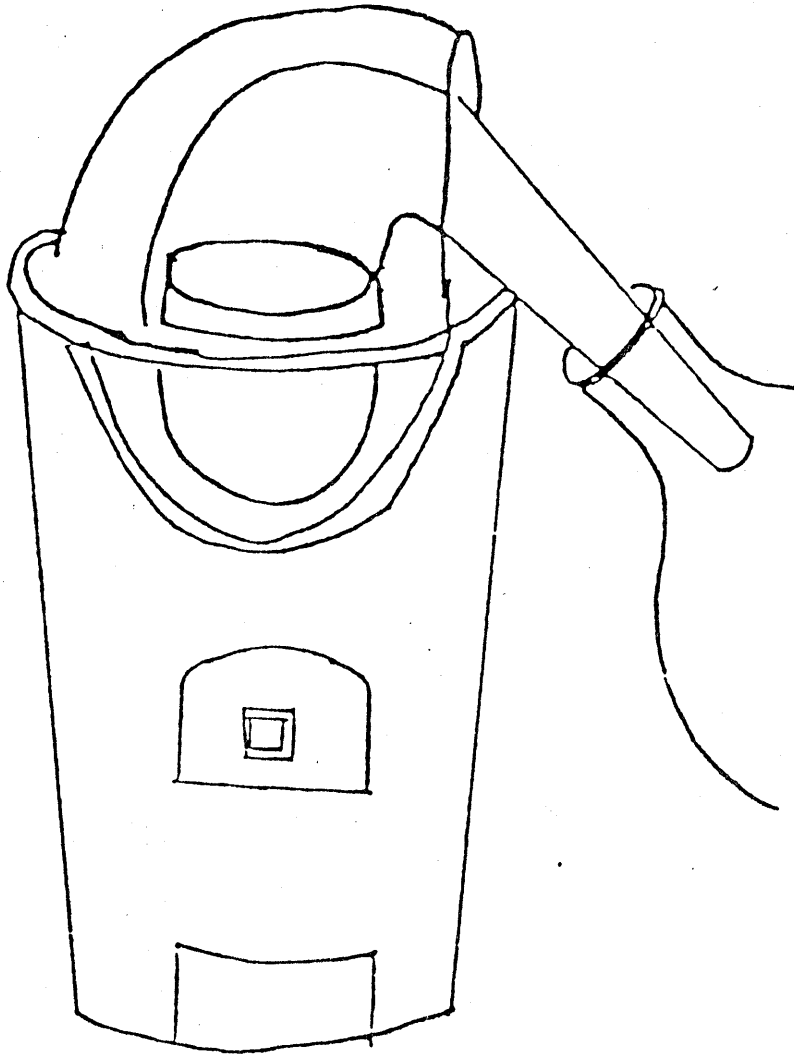

## SUBTILISATION OF GOLD BY MARTIAL REGULUS OF ANTIMONY AND SUBLIMED MERCURY

Take one part of very pure gold in small bits, melt it, with 3 parts of very pure martial regulus of antimony, after it is melted let it grow cold.

Reduce the brittle mass to a fine powder, mix with one part of this powder 3 parts sublimed mercury, previously reduced to powder and then mixed.

Put it in a glass retort, which bury in sand, in the sand pot, and distil first gently, then gradually increase your fire, until the sublimed mercury and the regulus has separated itself from the gold, and increasing gradually your fire, the gold will ascend like flowers, and a butyrum comes over into the receiver, from the sublimed mercury and the regulus. This butyrum comes first. Part of the gold hangs in the neck and part on the sides of the belly and a small quantity remains in the bottom of the retort.

Take the flowers of gold out carefully, which are a subtilised opened calx of gold.]

### OPERATION WITH THE ABOVE CALX OF GOLD IN VIA HUMIDA TO SUBTILISE IT STILL FURTHER AND DISTIL IT OVER AS AN OIL PER ALEMBICUM, OR PER RETORT

Take your subtilised calx of gold, put it in a glass with a long neck, and pour our first Menstruum upon it, so as to cover it, set it in a gentle heat over a lamp to digest and let it dissolve of the gold as much as you can.

When you find that it dissolves no more, decant very gently and carefully the clear gold coloured solution into a glass distilling body, perfectly dry and clean. (It dissolves with a gentle ebullition and bubbling).

Pour new menstruum on the remaining gold and digest as before; decant again the tinged liquor carefully, and pour it to the former solution.

When all the calx of gold is dissolved, take all the solutions together and put them into your glass distilling body or into a glass retort.

If you use a body, lute an alembic over the body, which place on a baln. vaporis, and adapt a roomy receiver.

Then distil the Menstruum over, until the dissolved calx of gold remains behind like fluid honey. Pour as much fresh menstruum upon the gold as you have distilled from it, and distil it over again on your vapour bath, until the appearance of gold is like honey.

This distillation, every time with new menstruum, must be reiterated for a whole month, once a day; then place your vessel in a sand heat, increasing your heat gradually, and you will see a part of your dissolved gold go over like a deep gold coloured liquor or oil, but the greatest part will sublime into very tender flowers.

These flowers you must dissolve with new menstruum, distil the menstruum from it in B. Vap. and then placing the vessel in the sand, you will get more of the gold coloured oil over; and in this manner you must proceed, until every grain of your dissolved gold is come over in the form of a gold coloured thickish oil. You must have a sufficient quantity of menstruum ready for this purpose.

As soon as all your gold has thus been volatilised in via humida, you then rectify it 3 times per se out of a small glass retort.

### FURTHER PROCEDURE WITH THE OIL OF GOLD TO OBTAIN A TRUE POTABLE AND MEDICINAL GOLD

Put your volatilised oil of gold into a small glass body, pour genuine well rectified S.V. upon it gradually and carefully, a little only each time, let it stand until the ebullition ceases, and then pour on it a little more, proceeding thus gradually, until you find that your oil of gold is perfectly dissolved in your S.V.

Whilst you do this you must tie some writing paper over your body.

Now lute an alembic on your body and place it on a baln. vap. over the lamps or a gentle charcoal fire, and distil about  $\frac{3}{4}$  of the S.V. from the gold into an adapted receiver.

Pour new S.V. as much as you distilled of, on the gold, digest it 24 hours in a most gentle warmth, then in baln. vap. distil the S.V. from it again.

This process must be repeated with new S.V., digesting and distilling of each time, until the S.V. has carried over the corrosive spirits, which remained with the gold from its first solution; therefore when you find, after 5 or 6 distillations, that the S.V. comes over of a pleasant taste free from corrosiveness, then your labour is done; distil then the spirit of wine of until your gold medicine remains behind like honey, of a very deep colour.

### ITS USE

This dissolves in every liquor, and well deserves to be called a genuine Aurum Potabile, and is as volatile as mercury.

It unites immediately with our blood and fluids, and as it remains unaltered it can by circulating with the blood invigorate us, and enable nature to remove every disorder. I believe it to be one of the highest medicines in nature, after the philosophic stone; yet it is not the most universal medicine, but is nearest related to the Mineral Kingdom.

## A PARTICULAR LABOUR WITH THIS GOLD FOR METALS

After your gold has been sublimed into flowers, and those flowers have been distilled over per retort by the help of our corrosive menstruum, you must pour that solution into a large quantity of distilled water, rain water, and drop into the water 12 times in weight of animated or sophic mercury to 1 part of gold used in the beginning. For this operation you must take a large glass matrass, with a narrow mouth.

In this glass body you pour the dissolved gold, with the animated or sophic mercury, shut the opening with your thumb, and shake the glass a good while, and the animated mercury will attract all the gold and become an amalgam, in the water.

To know after a good while shaking, whether there remains any gold in the water, pour a little of this water into a clean wine glass, and drop a few drops of spirit of sal ammoniac into the glass, if this water becomes red, it is a sign, that all the gold is not yet amalgamated with the sophic mercury, therefore you must shake your glass until there remains no more gold in the water.

Then pour the water carefully from your amalgam into another body, and pour fresh distilled rain water upon your amalgam, shake it again as before, and pour it of to the former; repeat this 2 or 3 times, then dry your amalgam, and examine all your waters by the spirit of sal ammoniac.

If there remains any gold in the waters a little more animated mercury will attract it, which put then to the former amalgam.

## PARTICULAR PROCESS WITH THE AMALGAM

Take your amalgam washed clean and dried, put it in a digesting globe of such a capacity, that half the globe or more may remain empty.

Set it in a sand heat, cover the glass with paper until all humidity is evaporated, then put in the glass stopper.

Keep it in a gentle heat one month night and day, it will pass through various colours and become a red powder.

The last 3 nights and days, after one month is elapsed, give a very strong heat, so that it may flow or at least become firmly united.

Break the globe to get it out and reduce the mass with borax in the crucible, and you will find your animated mercury fixed into fine gold.

If you have used one ounce of calx of gold and 12 ounces of animated mercury, you will now find nearly 13 ounces of pure gold.



## UNIVERSAL PROCESS WITH THE SAME AMALGAM

Think about this and consider whether it might not be possible to increase this power in a high tinging medicine!

The fixed powder consisting of volatilised gold and sophic mercury is truly a seminal gold, whose central tinging power is turned outwards, or else it could not have fixed your sophic mercury in one month time, therefore consider in your mind whether this seminal gold might not be increased in its tinging power by repeated subtilisations?

I would proceed thus:

Take of your fixed powder, in the room of reducing the whole quantity to common multiplied or new generated gold, 1 ounce, dissolve this in our corrosive menstruum and volatilise it by frequent distillations, until it goes all over into the receiver, exactly in the same manner as you treated the flowers of crude gold, thus volatilised and the corrosive taken from it by rectified S.V. and evaporated to dryness; combine this volatilised gold with half its own weight i.e. 1/2 an ounce of such volatilised gold as you prepared with sophic mercury into an amalgam; this is one ounce of volatile gold and 1/2 an ounce of amalgamated gold, as has been taught before.

Mix and put into a digesting globe, digest with a gentle heat and fix it gradually. It will be finished in a shorter time! It is an infant which may be conducted to manhood. Consider of it and you will not be sorry for it.

## OF VITRIOL

**Note:** We hesitated before including this part of the text in our lessons, however we find here much additional information. In our opinion, read it but it is perhaps better not to experiment with it.

Vitriol is a mineral salt, proceeding from dissolved metals in the mines. Therefore we have various sorts of vitriol, such as vitriol of copper, vitriol of iron, vitriol of iron and copper mixed, vitriol of gold, which is the Salzburg vitriol, white or zinc vitriol, containing a white metallic earth.

The most common vitriols are those of copper and iron, all of them containing a burning sulfur.

The preparations of vitriol are various and numerous. We will only mention such as are necessary.

## SPIRIT AND OIL OF VITRIOL

**Note:** The making of sulfuric acid.

Take 2 or 3 lb of vitriol, put it in an iron pot which set over a naked fire, stir it until it becomes a hard and dry mass.

Reduce this mass to powder and mix with it calcined and powdered flints twice the weight of your powdered vitriol.

Put this mixture into a coated retort of earth, set your retort in a convenient furnace, so that the retort may receive the naked fire, lute a large balloon receiver to the retort, and let the lutum get perfectly dry. In the receiver you must put a little clear water to receive the spirits.

Then make at first a gentle fire, and a phlegma will come over first, increase the fire gradually and the volatile spirit of vitriol will follow the phlegma and at last with a very strong fire, so as to make the retort glow, the ponderous oil of vitriol comes over in heavy vapours.

The next day when the furnace and vessels are cold, unlute your receiver carefully, and pour all the liquid out of the receiver into a roomy glass body, set an alembic on the body and adapt a receiver. Place your body in a sand heat furnace, and distil with a small heat and the phlegma vitrioli united to the water will come over. Thus far you have luted nothing.

When you perceive that sower drops begin to come over, take your receiver away with the phlegma.

Apply now another dry and clean receiver and lute it, increase your heat with a little and the acid volatile spirit of vitriol will come over, when you perceive that in this same degree of heat, which force the spirit over, no more does ascend, then let the fire gradually die away.

Now you have the spirit of vitriol in the receiver and in the glass body remains the ponderous dark coloured oil of vitriol.

If you put this oil into glass retort, adapt a receiver unluted, and lay the retort pretty deep in a sand heat and raise your heat gradually, until the oil of vitriol boils in the retort, it will clarify itself, all the colour will come over, and the oil which remains in the retort will become as clear as rock water. After it has purified itself, let the fire go out, take your clarified oil out of the retort, and pour it into a glass with a glass stopper.

This oil is perfectly liquid when warm, but when cold it is a transparent acid mineral salt, on account of being so highly concentrated; it is also the most ponderous mineral liquor prepared by art.

(I have once distilled it over in a sand heat, and I was obliged to raise the fire to that degree, so as to cause the iron pot to become red hot, and my clarified oil came rolling through the neck of the glass retort in little clouds, which succeeded each other, it required a very strong fire, because it is so ponderous).

From the first caput mortem, when you made the dark oil first (which caput mortem is called Colcothar and is of a fine red colour) you may extract with boiling water a sal vitrioli as white as snow. If you cement silver with this salt, it becomes Luna Fixa, which is nothing less than white gold, as aqua fortis nor spirit of niter does not touch it.

Helmont and Boyle order the Colcothar to be reduced to a subtil powder and to be mixed with sal ammoniac in equal parts, and then to be sublimed in a sand heat, and thus they obtain their ENS of copper, or ens of iron according to the nature of their vitriol.

Basilus Valentinus and his ammanuensis Iodocus Von Rehe have made a tinging medicine called Lapis Philosophorum from Hungarian vitriol; I have never done it, although Kunkel Von Lowenstern says he made this stone out of vitriol after one of the processes communicated to the Prince Elector of Saxony by Sebald Schwartzler in the year 1570. K. Von Lowenstern says that he transmuted 20 marks of silver into fine gold therewith.

Here is the process:

#### TO MAKE THE STONE OUT OF HUNGARIAN VITRIOL

Note that the Salzburg vitriol is a solar vitriol and is as good as the Hungarian; take either of these two g.v. : 10 or 12 lbs. Dissolve your vitriol in rain water, filter the solution, evaporate in large glazed basons until a film appears on the surface, then set your basons over night in a cold place, and it will shoot into crystals.

Repeat this process of dissolving your crystals, filtering the solution and evaporating until a skin appears, and then crystalizing over night, 10 or 12 times and you will obtain a most beautiful vitriol of a most sweet pleasant smell, but you will lose about half.

Take your crystals and calcine them in the sun and by no other method, until they are become a white powder.

If this is done whilst the sun is in Leo, you obtain Sir Kenelm Digby's sympathetic powder. This is the best calcination of vitriol.

Do not think that you can ever purify the vitriol completely by solution, filtration and crystallisation, if you were to do it 300 times, because the yellow metallic ochre, which separates itself at every filtration remains with the last grain of vitriol, and even without that yellow earth, the vitriol cannot shoot crystals.

Iodocus Von Rehe mentions that he became disheartened and tired, when he found that he could not entirely purify his vitriol; I say that 10 to 12 purifications are sufficient.

Your vitriol which you have calcined in the sun put in a roomy earthen or glass thick coated retort, place it on 2 iron bars in a furnace over a naked fire.

Now light your charcoal and give a gentle fire at first, during the first 3 or 4 hours, and a weak acid phlegma will come over first into the receiver which must be very large and carefully

luted on, and the lutum as well as the clay coating of the retort must be perfectly dry and hard, before you light your fire.

Raise your heat gradually and in the space of 12, 14 or 18 hours force all the heavy spirits and oil over in clouds into the receiver; the last 3 or 4 hours, your retort must be red hot below, or else you will not obtain the heavy oil.

Let the fire go out gradually of itself. The next day when the vessels are cold, take off the receiver carefully.

Pour the contents out of the receiver into a glass body, which place on a balneum vap. Set an alembic on it a adapt a receiver. Lute with strokes of linnen and cold paste. Now light your fire and make the bath boil, so that your glass body may receive the steam of the boiling water.

All the weak acid phlegma will go over into the receiver, and if your vitriol is Hungarian, or Salzburg vitriol, or a vitriol made of iron and copper, according to Basilius, you oil will become concentrated and remain in the body of a transparent deep ruby colour, whilst any other vitriol will not give you this phenomenon.

Thus far I have worked this process. Now we proceed according to Basilius and Iodocus Von Rehe.

#### SEPARATION OF THE PRINCIPLE IN VIA HUMIDA

Put your red oil into one or several matrasses with long necks, covered with double paper or easy wooden stoppers.

Set your matrasses or glass body in a gentle heat. (Such as horse dung) in digestion 8 days and nights or longer, and a natural separation will take place.

A clear transparent liquor will float on the surface and increase daily in quantity.

pour this clear liquor off carefully, and digest again 8 days and nights, and you will obtain more of that liquor. Pour this off again carefully. Continue the digestion until no more clear liquor or volatile spirit is separated and formed.

This liquor is the Mercurial spirit of Basilius or his spirit of mercury in forma humida.

Pour these liquors together in a small glass retort, and distil them over, so that no colour may ascend with it.

The red oil which remains after the separation of its mercurial spirit, you must also put in a glass retort, which must be coated with loam, and be placed in a sand heat.

Force this red oil over, increasing your fire gradually, until the red oil comes over in heavy rolling clouds.

There remains saline fæces in the retort. The above red is sulphur metallorum.

Calcine your fæces during 10 or 12 hours under a muffle, surrounded with burning coals, then extract the white salt with the first mercurial spirit, which spirit you must again distil from your sal metallorum. Now you have the three principles according to Basilius' process.

## COMPOSITION

Take all your metallic salt, and dissolve it in your mercurial spirit gradually in a very gentle warmth, but take no more mercurial spirit, than is necessary for the solution of all your salt.

Put this solution into a digesting globe of a convenient capacity and lute the mouth of the neck.

Set it in a gentle heat over a lamp, and let it stand there until the whole is coagulated into a white salt, which according to Iodocus Von Rehe will arrive in three months time.

Now weigh your red oil or sulfur and divide it in 7 equal weights. Take the first part and imbibe therewith your white salt. Set it in digestion and coagulate it. proceed in the same manner with the remaining 6 parts; one after another, until they are all coagulated and fixed with the salt.

Then fix your powder by gradual heat, and you will obtain the Stone of the Philosophers.

## MY OWN REMARKS ON THIS PROCESS

(i.e. The Author's Observations)

I have told you that I took Salzburg vitriol, which I dissolved in rain water, filtered the solution and evaporated it in as large glass body, until a skin appeared on the surface, then I set it over night to shoot crystals, which I told you has a most delightful smell; but I did not always perceive that sweet flavour, although I always took Salzburg or Hungarian vitriol.

I have dissolved my vitriol 10 times, which I think is necessary as well as sufficient.

If you repeat it still softer, you will always have yellow fæces, and at last the yellow earth of vitriol is separated entirely, whereby the vitriol is destroyed, so that it is no longer a vitriol.

The red ponderous oil is like butyrum of antimony and attracts humidity out of the air, and thus become fluid, otherwise before attraction it congeals like ice.

It attracts this humidity even through the pores of glass, whilst a clear liquor separates itself from the ponderous sulfureous oil and floats on the surface, which is Basilius and Von Rehe their spirit of mercury.

This I separated by means of a small funnel. The remainder, which will yield no more clear liquor or spirit of mercury, is the Sulphur embryonatum Vitrioli Veneris of solar property.

This red oil you must distil over per retort and a black earth remains, wherein the salt of vitriol is hidden.

This black earth must be calcined under a muffle then extracted with your acid spirit of mercury; this spirit you distil from the filtered solution, and there remains a snow white salt.

But your spirit of mercury must be rectified first by itself in a small retort.

There is something else to be minded, which is, that the red oil must be dissolved or diluted in the spirit of mercury, then distil the spirit of mercury from it, and your remaining red oil will be clear and beautiful and of a fine ruby color.

Thus far the process is true, and thus far I have worked it, but I had not time to go any further with it, nor did I want it.

The process appears to me to be rational and true.

After the spirit of mercury has been coagulated with the salt, and when after that, with the red sulfurous oil, which is an ingressive embryonated solar sulfur, it is again coagulated and multiplied as Von Rehe teaches, it can certainly and must, in the character of a concentrated fire, have a power to penetrate mercurial bodies and fix them into gold (after it has been first melted with salt in the crucible).

The lover of curious experiments may try this process, which I believe to be true, provided you meet with a good vitriol.

## OF SAL ARMONIACUM

This salt came originally from Armenia and therefore has been called Sal Armoniacum. At places where camels and mules belonging to caravanes usually stopped, this salt was generated by the sun, by means of the salt of the earth. The Venetians were the first who made this discovery, and as they had learned that this salt was generated from urine combined with the salt of the earth, they conceived that such a salt might be made artificially from urine and sea salt. if you take sea salt wood sut and urine, boil them together, dissolve it again with urine, the staler the better, then filter and evaporate the solution, you will obtain a very excellent sal armoniac. This is of infinite use in medicine as well as in alchemy.

In medicine the spirit as well as the volatile salt of sal armoniac is of great use.

Take fixed alcali or purified potashes and sal armoniac in equal parts in a subtil powder and mix well, put the mixture into a glass body with a large alembic and lute a receiver to it.

Distil with a gentle heat in sand or in baln. vap. and the volatile salt of urine, diluted in phlegma, ascends and comes over, and is called the spirit of sal armoniac.

In the alembic a beautiful white volatile salt will sublime and fasten there, which has the same virtues with the spirit ( or volatile salt dissolved in phlegma).

### SPIRIT OF ARMONIACUM - ITS VIRTUE AS A MEDICINE

It resists the acid in the stomach, bile and not only in the stomach but in the bowels also. 50 to 60 drops in a wine glass full of water.

Out of the caput mortem you may boil a salt with water, filter and evaporate the solution, and you will obtain a good antifebrile salt. 20 or 30 grains is a good dose in fevers.

### ITS USE FOR METALS

If you cement laminated fine silver with sal armoniac, it gets heavier, and is sooner graduated into luna fixa or white gold, which can also be done with sea salt and calx.

If you dissolve sal armoniac in rain water, and extinguish red hot bricks therein, the broken pieces of bricks imbibe the solution.

Distil this in an earthen retort over a naked fire, and you will obtain a spirit which dissolves gold in leaves without corrosion, and carries it by distillation over the helm.

Dissolve sal armoniac in rain water, distil the water from it, and part of the sal armoniac will come over.

What remains dissolve again, separate the fæces, distil again and more sal armoniac will be volatilized and come over.

Repeat this labour until all the sal armoniac is come over along with the water.

Now distil half of the water from what is come. What remains behind distil with a strong heat per retort, and your sal armoniac will be subtilised and volatilised more and more.

What is now again come over, distil in a glass body and alembic over a balneum vaporis as long as any phlegma goes over; what remains behind in your glass body is a thick oily liquor.

Set this liquor in a cold cellar, and saline crystals will shoot, which are extremely fusible and penetrating.

These crystals dissolve a calx of gold radically if placed in a gentle heat in a digesting globe, and dispose the gold to become a tincture for transmutation.

Your calx of gold your must take with sublimed mercury and martial regulus of antimony, as I have taught in the section of Gold.

Gold prepared in this way, if further dulcified and dissolved with S.W.R. becomes a most glorious Aurum Potabile.

Ora et Labora!

THE PHILOSOPHERS OF NATURE





THE PHILOSOPHERS OF NATURE

Copyright © 1989 by LPN-USA

Lesson 84 - MINERAL - page 1

C.84.1290

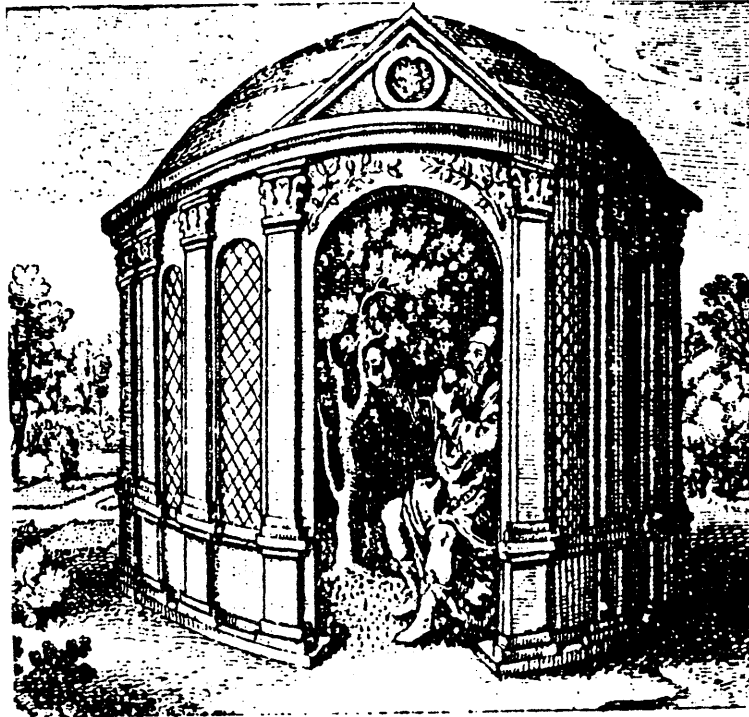

The alchemist rests in the garden of the Hesperides.

Dear Friend,

This lesson is somewhat long because we included several of texts dealing with the Secret Fire, which have their place only in this lesson.

The last text Chemical Moon Light must be studied very carefully because it is an uncommon process that enables us to obtain an undetermined Secret Fire, which is not the case with the first texts. This important experiment leads us to believe that, even when undetermined, the Secret Fire has two aspects.

In the theoretical part of these lessons, the aim is to provide a body of alchemical knowledge authorizing a Knower's work and no longer the use of empirical formulas. Once you have made your choice among the paths we presented, you should not however give up the study of the other ones, because they all complete each other in the aim of deepening your knowledge.

Therefore, with this lesson, we are completing the first addendum to the Mineral lesson. The work which is proposed is the result of a collaboration between some of the LPN-France association members and this work is still in progress. We hope that your experiments and your studies will give evidence to the value of the documents we presented. We also wish that you make only a personal use of it.

Always keep in mind that patience is necessary in the work and that the student must strive to possess three things:

- a generous heart;
- a solid mind;
- a skilled hand.

Good Luck!

## THE MEDICINES

The medicines resulting from the methods studied can be directed toward the mineral kingdom or toward man. We did not address this issue in this addendum to the Mineral lessons because all the related details are given in Mineral Lesson # 30, starting from Aphorism 14.

The stone's or the medicines' power depends upon the concentration of Fire in the supporting material. The increase of power during the multiplication shows that at the beginning, the element Fire is not saturated and that the concentration of this element is possible.

We have said previously that the Fire could be attracted by magnets (in our opinion the two best magnets are potassium carbonate and antimony trichloride). The use of magnets brings about an unavoidable drawback: the Fire then becomes a determined fire. The undetermined Fire has an enormous advantage, because the resulting product is then truly universal.

\* \* \* \* \*  
\* \* \*  
\*

## THE WAY OF CINNABARIS

Some members of the association talked of a way close to the way of cinnabar. In this way, the basic products are mercury, sulfur, and potash. Potash is set to deliquescence. In the documents we possess, nothing is clearly specified but it seems obvious that the deliquescence must take place during the days following the spring equinox. The potash is then charged with solar Fire which, as a result, is determined as a vegetable fire. But, as we have explained before, vegetable life can only be transferred onto bodies that have a 4-electron outer shell i.e., carbon, silicon, germanium, tin or lead. As this is not the case with mercury, potash is of no interest.

If we want to use an efficient way of cinnabaris, the solution is simple. The mercury must be alive, i.e. we must use a mercury revived by antimony, through the way of the amalgams.

What is missing in this mercury in order for it to evolve? The metallic oxygen, i.e., the sulfur. Therefore we take native sulfur purified by carbon tetrachloride in a soxhlet, and dried in the sun.

With this sulfur and our mercury, we make a cinnabar (use mask and gloves). If the mercury and the sulfur are appropriate, no sublimation is necessary; on the contrary it could be damaging inasmuch as our Fire has been imperfectly fixed.

- Proceed with the sulfur-mercury mixture using roughly a 1/7 ratio;
- Make sure there is no free mercury or excess sulfur;
- Operate with patience;

- Then set into an incubator with an initial temperature of 40 C. Watch the evolution which in this case is very quick.

**Notes:**

1) The limit of the evolution is determined by the choice of the regulus of the amalgam, that is:

- lunar martial regulus: white;

- venusian lunar martial regulus: red.

2) The sulfur must be obtained by the cooling down of the tetrachloride, because in that case it is obtained in a crystallized form. After an extraction, never continue to heat a soxhlet extractor, if there are crystals at the bottom of the flask; in this case, change the flask and recoup the crystals.

# LULLY'S THEORY OF THE PHILOSOPHER'S FIRES

Translated by S. Bacstrom

Our Fires, without whose knowledge the Magistry is not perfected

In this there are contrary operations, because as Fire against Nature resolves the spirit of a fixed body into the water of a cloud, and the body of a volatile spirit is thereby fixed into congealed earth; so, on the contrary, the Fire of Nature congeals the dissolved spirit of a fixed body into a glorious Earth, and resolves the fixed body of a volatile spirit not into the water of a cloud but, into the water of the Philosophers. Because that which is fixed by virtue of the Fire of Nature becomes volatile; a spiritual body into a spirit; humid into dry; heavy into light - and on the contrary fire against nature changes volatile into fixed, and fixed into volatile; body into spirit and spirit into body; humid spirit has the form of the water of the cloud and a constrictive ponderosity.

Understand by this that fire against nature is so called because it is against all natural operations, for the token which the fire of nature composes this always decomposes and destroys and carries to corruption unless the nature of fire be added.

Hence we say that such fire in the operation of Nature is not of the virtue and operation of our magistry, but that fire only which is purely natural.

There are four Fires:

1. Natural which is in our Ardent water perfectly rectified;
2. Unnatural, as the heat of a dung-hill, a vintage, etc.;
3. Elemental, which is common fire;
4. Against Nature, a heat corroding all things, as aqua fortis, which is drawn from vitriol, salt petre, etc., & sal armoniac and other mineral things.

And you must know that the heat of the Elemental fire can never draw sulphur of nature from the veins of a body, which nevertheless the Fire of Nature by its own attractive virtue easily does.

\* \* \* \* \*  
\* \* \*  
\*

THE SECRET FIRE  
(According to Paracelsus)

AUREOLI THEOPHRASTI PARACELSUS  
ARTHIDOXORUM SEU DE SECRETIS NATURAE LIBRI DECEM. IT EM  
MANUALIA DUO ETC. BAVILEA  
M.D.L. XXXII

A tincture you shall make as one makes oil of Vitriol, by means of a gentle heat (He means during the digestion).

Take of this hanged thief (Mercury) one part. Prepare him over a gentle  $\Delta$ , until he becomes snow-white.

(He means that you shall sublime your  $\phi$ , which appears from the expression of the hanged thief [ $\phi$ ] therefore you are to take of a good snow-white  $\phi$  one part).

The  $\cup$  in subtle filings also one part and 2 parts of the high flying eagle (Sal ammoniac purified from its black  $\nabla$ , by sublimation).

(Note here that in Paracelsus' time the  $\phi$  was imported into Germany by the Hollanders from Armenia and Arabia, and was very black and impure, so that they were obliged to purify their crude  $\phi$ , by subliming it from sea  $\phi$ ; such a purified  $\phi$  was still common, although pure  $\phi$ , therefore we must not take our sublimed or volatile  $\phi$  in the room of the common, as the common is meant here and no other.

Mix these ingredients ( viz.  $\phi$  1 part, filed fine  $\cup$  1 part and clean common  $\phi$  2 parts). Put it into a  $\nabla$ , lute a cover on it, and when dry set it in a wind-furnace, cover it with coals, and let it melt well, follow my advice, says P. then pour it out and let it cool in the heated cone; when it is cold, beat it to powder; squeeze the powder through a strong cloth, and look for the living thief (the revived  $\phi$ ) and take care of him.

What remains in the cloth, copel by or with lead to recover some of your  $\cup$ .

## COMPOSITION

Now take one part of the thief's  $\nabla$ , and one part of the thief, which you squeezed through the cloth (and which is an animated lunar  $\phi$ ) put these two  $\text{aa}$  into a digesting glass, which shut close, and place the glass on a gentle heat, and it will be dissolved into a  $\nabla$ . If you perceive this you are right.

Continue your gentle digestion, the glass kept closely shut, until the  $\nabla$  is dried up into a white powder or calx like fine  $\cup$ .

## MULTIPLICATION

Dissolve this in the cold (placing the opened glass in cold  $\nabla$ ; or open it and let it dissolve by attracting the humidity of the  $\Delta$ , so that it becomes  $\nabla$  again; but do not take the  $\ominus$  out of the glass; I know P. means this, from other processes).

Coagulate this again by gentle heat, the glass shut again; and repeat this operations at least three times, until it flows without fuming; and you will have a powder (a Rx - tincture) believe me, which transmutes rogues and pious into fine  $\mathcal{D}$ , and it does it in a large quantity. (The pious are the Mercurial Metals, such as  $\mathcal{F}$ ,  $\mathcal{Y}$ ,  $\mathcal{S}$ , the rogues are the refracting metals, who have but a little  $\mathcal{F}$ , such as  $\mathcal{Q}$  and  $\mathcal{M}$ ).

The thieves  $\nabla$  is the solvent upon the running animated Lunar  $\mathcal{F}$ ; he certainly means a  $\mathcal{F}$  ial  $\nabla$ , but what sort of one I cannot tell, But,  $\mathcal{S}$  is also a  $\mathcal{F}$  ial  $\nabla$  or sophic  $\mathcal{F}$  simplex, so is the white oil of Justanus and the red oil much more, as a double animated sophic  $\mathcal{F}$  ex  $\mathcal{S}$ .

I give you this to show you how easily a tincture may be made with the right principle and right solvents!

If we could find out this thief's  $\nabla$ , this process should be one of my first works; he says in another place, that it is done in 6 weeks time and in no trouble.

Consult R. Boyle in his Corpuscular Philosophy where he speaks of  $\mathcal{D}$  cornea and  $\mathcal{F}$ ; an experiment he once made.

Whosoever possesses the knowledge to tinge the Sophic  $\mathcal{F}$  with  $\mathcal{O}$  or  $\mathcal{D}$  will obtain the great Arcanum!

Finis



# EXPERIMENTS FOR THE PREPARATION OF THE PHILOSOPHICAL MERCURY by means of the Moon and the Martial stellated regulus of antimony

Eugeneous Philalethes

Note: This text confirms everything we have previously presented.

## 1. The secret of the philosophical arsenic

I took 1 part of our Fire dragon and 2 parts of the magnetic body ; I prepared them together with a strong heat and by the first fusion we obtained about 8 ounces of the true arsenic.

Note: Fire dragon = regulus of antimony  
Magnetic body = iron or steel  
True arsenic = martial regulus of antimony

## 2. The secret of the preparation of the mercury with its arsenic by separating it from it fæces.

I took 1 part of the best arsenic and united it into one single body with 2 parts of the virgin Diane; I ground them very finely and with this I prepared my mercury, working them together by heat, until they were excessively blended; then I purged them with the urine salt, until the fæces separated, which I put aside.

Note: Virgin Diane = silver metal  
Urine salt = sal ammoniac

## 3. The purification of the Philosophical Mercury

The mercury thus prepared is still corrupted by an external impurity, that is why it must be distilled 3 to 4 times in its own alembic with a curcubit of steel, then leach it with the urine salt until it becomes clear and shiny and it does not leave any trace behind it, when you move it.

Note: The tri-distillation that we propose is simpler.

## 4. Another still better purge

Take 10 ounces of decrepitated sea salt and 10 ounces of the scoriae of Mars, 1 and a half ounce of prepared mercury, grind the salt and scoriae very finely, together in a marble mortar ; then pour the mercury and grind it with vinegar until the mercury no longer appears; pour it into a glass flask and sand-distil it in a glass alembic, until the mercury rises, pure, clear, and marvellously shiny; do this three times and you'll have the mercury very well prepared for the magistristry.

Note: Same as for 3 ; purification using sea salt and vinegar may be useful for a first cleansing. This operation is not too hard on the quartz distillation flask.

### 5. The secret for the correct preparation of Philosophical Mercury

Each preparation of the mercury with its arsenic is an eagle; when the feathers of the eagle are purged of their crow-like blackness, make the eagle fly up to its seventh flight; likewise we need up to 10 flights to prepare it.

Note: The mercury is amalgamated with the martial lunar regulus of antimony. The whole: amalgam + distillation + purgation = an eagle.

Here the silver may be reused but not the regulus.

### 6. The secret of the Philosophical Mercury

I took the appropriate quantity of mercury and mixed it with its true arsenic, i.e., about 4 ounces of mercury and mixed them to obtain a consistency that is not too thick ; I purged in the right way and distilled it and I obtained a pure Moon body, whence I concluded that it was correctly prepared; then I added its weight in arsenic and augmented it of its previous weight of mercury, inasmuch as the mercury can form thin layers, and I purged it in this way until exhaustion of the blackness and until it turned into a lunar whiteness; then I took 1/2 ounce of arsenic with which I made a true marriage, I added the betrothed mercury, which was done at a temperature slightly lower than that of baking pottery, then I purged it again in the appropriate way; the purging was slow and pains-taking, I did it with urine salt, which I found was more appropriate for this work.

Note: Detailed description of one of the previous eagles.

### 7. Another still better purge.

I found a better way to purge with vinegar and sea salt, so that in half a day I could prepare an eagle ; I saw the first eagle fly and Diane was left with some copper tincture ; I began the second eagle removing superfluities and then I made it fly and again the doves of Diana were left with the copper tincture ; I added the third eagle and purged the superfluities by removing them, even when white, then I made it fly and it left a greater part of the copper behind, with the doves of Diane ; then I let it fly twice by itself, up to the complete extraction of the entire body ; so I added the fourth eagle, gradually adding more and more of its own humor, and it was made of a very moderate consistency in which there was no *hydrops* (or superfluous humidity) as there was in the first three eagles.

Note: Actually, same operation but the regulus is a lunar venusian martial regulus for the red stage of the work.

### 8. I found the best way to prepare the Philosophical Mercury, as follows:

I put the amalgamated mass, espoused or joined very intimately by an appropriate marriage, in a sand-furnace for an hour and a half but in such a way that it cannot sublime ; then I take it out and strongly grind it ; I put it again in the furnace and after about a quarter of an hour, I grind it again in a hot mortar, so that the amalgam starts to cleanse itself and rejects a great quantity of powder ; then I put it in a crucible and in the furnace as before, for an appropriate time with as strong a heat as possible without ever reaching the point of sublimation ; I constantly put it into the furnace and grind it continuously until all the powder entirely disappears; then I leach and the fæces are easily rejected and the amalgam becomes free of any heterogeneity ; then I leach it with the salt and again heat it and grind it ; I repeat this process to clean it entirely of all kinds of fæces.

Note: Operation for the long way, the amalgam is purified without being distilled.

### 9. A triple test of the good quality of the prepared mercury

Take the prepared mercury with its arsenic of 7, 8, 9, or 10 eagles, put it in a flask that you lute with the lute of wisdom ; put it in a sand-furnace and keep it at a sublimation heat, so that it can rise and come down in the flask until it becomes coagulated in a manner slightly thicker than butter ; continue up to a perfect coagulation, so that it is as white as silver.

Note: Explanation that only concerns the lunar martial regulus for the white stage.

### 10. Another test

If, by shaking it in the flask with urine salt, it becomes by itself an impalpable white powder, so that no mercury appears, and if by itself it coagulates as a slightly thick mercury in a dry and hot place, it is enough. But it is perhaps better to shake it in spring water, it runs as little heads or particles, because if the body is granulous, it won't be transformed and separated into very tiny parts.

Note: Another solution for the purification of the amalgam.

### 11. The third test

Distil it in a glass alembic placed on a glass curcubit, if it distils without leaving anything behind it is a good mineral water.

### 12. The extraction of the sulfur out of the living mercury by separation

Take your spiritual and physical mixture whose body is the coagulation of the volatile through digestion, and separate by means of a glass retort the mercury from its sulfur and you will obtain a fixed Moon, resistant to aqua fortis, and of a mass specific to common silver.

### 13. Magic gold extracted from silver

Through heat, you should extract a yellow sulfur from the white sulfur, through a handmade operation; which sun is the minium of the philosophers.

### 14. Out of sulfur, aurum potable

You can transform this yellow sulfur into an oil as red as blood, by circulating it with the volatile, mercurial, philosophical menstruum, thus you obtain an admirable panacea or universal medicine.

### 15. The rough conjunction of the menstruum with its sulfur for the formation of the lineage of fire

Take your best prepared mercury and chose among the 7, 8, 9, or at the most 10 eagles (Translator's note: that has been sublimated 10 times at the most) mix it with the prepared laton (brass) or its red sulfur, i.e., 2 parts of water or at the most 3 parts with 1 part of pure, ground, and purged sulfur: Note: it is better to take 2 parts for 1.

### 16. The mixing work by hand

You must grind your mixture thoroughly on a marble board, then leach it in the vinegar and sal armoniac, until it rejects all its fæces and then leach it with spring water, and you will remove its bitterness and saltness, then you must dry it on white paper, turning it around from place to place with the tip of a knife, until it is excessively dry.

### 17. Placing the foetus in the philosophical egg

The matter being dry, put it in an oval shaped glass, of the best and clearest glass, of the size of a hen's egg, in such a glass the matter should not exceed 2 ounces, seal it hermetically.

### 18. The regimen of fire

You must have a furnace in which you can maintain a constant heat, in which you can obtain the heat of a sand fire at the first degree, in which the dew of our mixture may rise and circulate day and night without interruption, etc.

In such a heat, the body dies and the spirit is born again and eventually the soul will be glorified and united with a new body, immortal and incorruptible; thus a new sky is made.

Notes 11 to 18: Without comment, paragraphs similar to those of the Coelum Philosophorum.

\* \* \* \* \*  
\* \* \*  
\*

## CHEMICAL MOONLIGHT

Translated by S. BACSTROM

Note: Description of a method for the direct extraction of the undetermined Secret Fire. The extraction in this case must occur without "magnet".

The work is accomplished with only one thing, and this should be taken literally. Read the second part of the The Aqueous Stone of the Sages, the Novum Lunem by Sendivogius, the Olympus Terrae by Theophras and Ali Puli. These authors say we should leave aside all animal, vegetable or mineral subjects. Only take our  $\nabla$ , dew, collected in  $\mathcal{L}$ .

Sendivogius in his treatise on  $\triangle$  says: "There is in the air a secret food for life, which is called Dew during the night, but  $\nabla$  or  $\triangle$  during the day, whose coagulated invisible is worth more than the entire earth.

Our body is a celestial  $\ominus$  by means of which we open the metallic body  $\odot$  or  $\lrcorner$  in  $\triangle$  open in a  $\nabla$ , and during this resolution the elixir is made, i.e., after the astral  $\ominus$  has been obtained and extracted from the lunar, viscous and greasy  $\nabla$ , it is the universal key to open the fixed bodies of  $\odot$  and  $\lrcorner$ . Our matter is a virgin  $\nabla$  which has never received the rays of the sun, even though the sun is its father and the moon its mother (and that the wind bears it in its belly).

This glorious matter must be collected in valleys, hills, even caverns, or in your own house. It is called Heavenly Dew, the  $\odot$  of nature, the grease of the earth. It is an astral spirit which is in the air and which is attracted by all vegetable, animal, or mineral species. But in the air it is still universal and undetermined; that is why we do not collect the dew which has touched the grass or the trees, because the spirit is already determined and therefore damaged.

The solar and lunar rays or celestial dew must be collected at the right time ( $\mathcal{L}$ ), in a clean vessel; rain, dust, the stench of smoke or other effluvium damage it. There are many magnets, however success depends as much on the place, gallery, weather, wind as on the magnet.

During a big storm, strong gusts of wind, heavy rains during the spring, this  $\lrcorner$  which the sun has extracted from the earth and the ocean, is copiously and abundantly gathered in the atmosphere and pulsated towards earth and attracted by plants, by men and by the magnets well prepared as receptacles. The stormy weather, when the wind blows from the south or south-east is very good. Extreme cold or heavy heat gives nothing.

The place must be dry, clean and free, neither marshy nor muddy. Your gallery must be oriented south-north. The vessels must be 6 feet above ground. A gust of wind passing through the gallery is very useful. (Editor's note: it seems that the author uses an equipment to collect the dew hidden in what he calls the gallery. It could be a barn or a shed-type structure).

There must be a harmony between the place and the receiver to collect this ☉ in sufficient quantity.

### Method

Collect about 8-16 ounces of our universal ☉, put it in a well-sealed flask and leave it to putrefy, which will take about 40 days. When the matter is well putrefied and quite black, divide it into ounces.

Take 1 or 2 ounces and dry them to obtain a ☽; from this ☽ or ☉ extract a pure ☉ and imbibe it with as much ☉ of ☉ that you took in the beginning, or a bit less and let it dry in the ☉, softly and naturally.

Once dry, give more milk to the child, i.e., of that milk out of which it was made, half less than the beginning quantity, and in this way use 2/3 of your ☉ of ☉ to imbibe and dry. Divide the last 1/3 in 7 parts ; imbibe your ☉ 7 times, drying it each time.

After the 7th and last imbibition, test your matter on a red hot ☽ or ☉ board , and see if it flows and penetrates without smoke: if it smokes, continue the imbibitions until it is perfectly prepared.

Then take one part of your universal wax and 2 or 3 parts of fine ☉ or ☽ and put them into a ☽, the cover well luted, and keep it in fusion for 3 or 4 days in the ☽ and the added ☉ will become friable and shiny and becomes the medicinal tincture. The experiment will show the force of the projection.

Time and patience are necessary to prepare the ☉ of wisdom in a natural way, because its tinging power should not be destroyed by too much heat. The matter must be dried in a natural, unsophisticated way, like a furnace, horse manure, or even the heat of a lamp. Dry it at the heat of a brooding hen.

The matter has the inherent power to become perfect; the philosophers say that the coction of their stone must be done in the heat of the sun (for this reason the translator believes that the ☉ is dried in the heat of the sun). You will obtain a ☽ or ☉ which must be purified of its fæces. the pure ☉ is then imbibed. The vessel must be waterproof and solid, not porous; leave enough place in the vessel for humidity to have enough ☽ to reject the heterogeneous excess or otherwise the work will stall and be damaged, without condensing nor drying in ☉.

After the putrefaction, the regeneration takes place starting from its own inside.

Our ☽ is not the ☽ of the clouds, or of a well, or of a spring but it is thick, fixed and salty, a dry and staining matter, that does not wet the hands, and it is a dirty water that originates from the salt and the grease of the earth. (The translator supposes that it is collected by deliquescence of the sea ☉ or ☉ used as a magnet).

Our matter is this  $\nabla$  that hangs above our heads in the  $\triangle$ . Theophrastus says: "You must take the Moon at the firmament and reduce it to water and then to earth and you will find the real matter of our stone".

The root of the philosophical matter is formed in the earth and is found in  $\nabla$  and  $\triangle$ , and this is the true matter, a  $\nabla$  which is not humid and yet an element of  $\nabla$  and is all one thing, which is the only  $\nabla$  to not be able to exist without the  $\nabla$  because it originates from the  $\nabla$  which is the food of matter and which nourishes it; it is filled with spiritual, celestial, earthly and magnetic life. (Based on this statement the translator says: "this strongly suggests to use  $\textcircled{1}$  as a magnet").

Refreshed by the pure celestial dew, the earth gives it shelter and is its mother. (The translator finds here another reference to  $\textcircled{1}$ ).

$\nabla$  resides with the  $\nabla$  and  $\nabla$  must become  $\nabla$ . This proceeds from our matter. ("Per deliquium" says the translator).

### Apparatus to attract the lunar humidity

(The figure on the last page is the frontispiece of the Tenth Volume of the Bactstrom Manuscripts)

The apparatus is not described in the text, however the author mentions the mirrors, spheres, and phials but not the set-up. It is impossible to know whether this figure represents an invention of Bacstrom or of someone else.

The funnel goes through a wall, possibly to prevent the smoke of the oil lamp to penetrate and pollute the lunar humidity; it is possible that this wall is a wall of the "gallery".

We suppose that the first sphere resting on the sand is heated by the oil lamp and that the hot air convection through the stopcock, takes in the fresh air of the night through the funnel as a vacuum cleaner, unless it is the difference in temperature that attracts the fresh air of the night inside. (The faucet is a problem because the air of the night would tend to escape through it). Keep the upper part of the two tubular receptacles cooled down by towels humidified by fresh  $\nabla$ .

The apparatus described by S. Bacstrom is not easy to use. We propose the following apparatus; there are two possibilities:

- One with a water circulation hence a great consumption of water;
- The second one by using a reservoir of water cooled down by ice and thermically insulated. A miniature electrical blower would insure the air circulation. Taking into account that the apparatus only functions for a few hours, at night, a definite load of ice insures a sufficient cooling down time.

### Description of the apparatus

We have in E the absorption funnel whose entrance is protected by a loosely woven cloth which prevents insects and coarse dust from penetrating.

The tube T is the condenser. It is kept cold by a reservoir filled with ice R, this reservoir is also covered by another reservoir filled with vermiculite (V), this device allows to maintain the condenser sufficiently cold during the night.

B is the receiving flask with two entrances, the second one is linked to a small vacuum turbine which insures the air circulation.

Ora et Labora!

THE PHILOSOPHERS OF NATURE

### Enclosed figures:

- # 1 - Direct Extractor of Solar or Lunar Fire
- # 2 - Bacstrom's Apparatus



Figure # 1  
C.84.1290

DIRECT EXTRACTOR OF SOLAR OR LUNAR FIRE

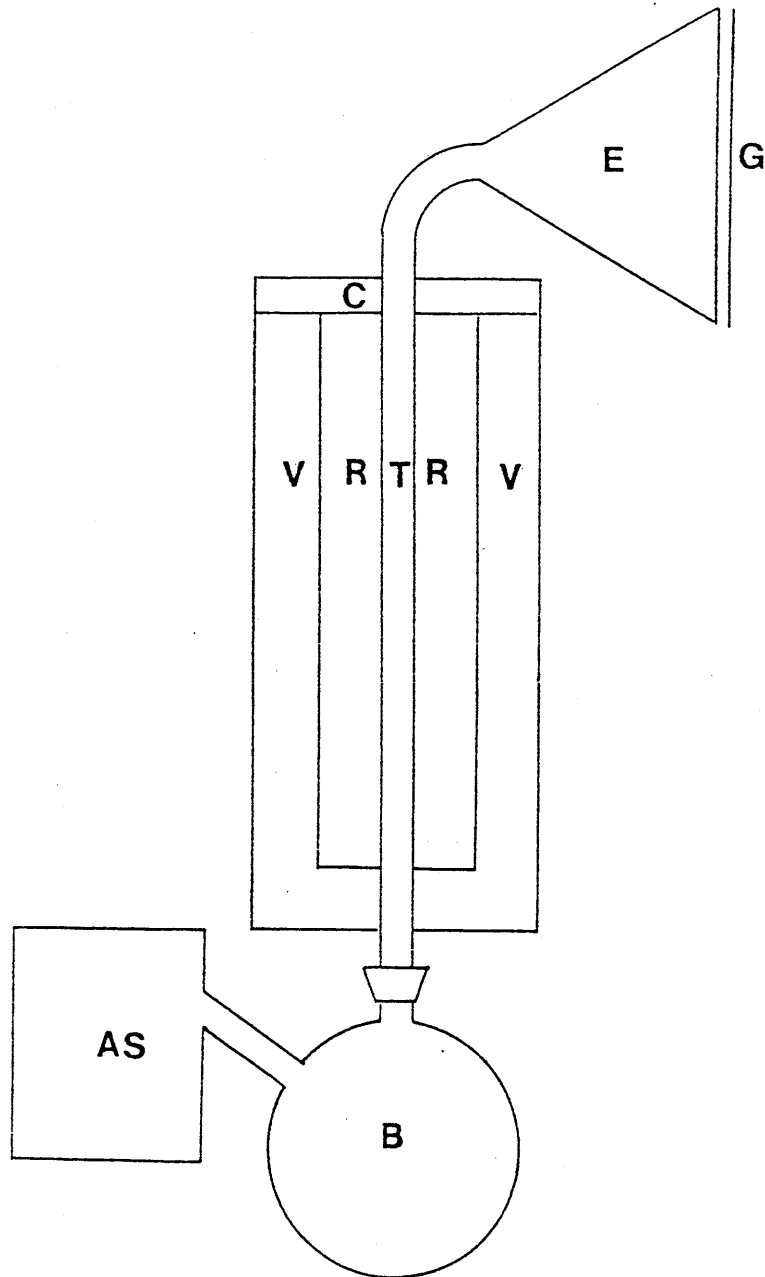
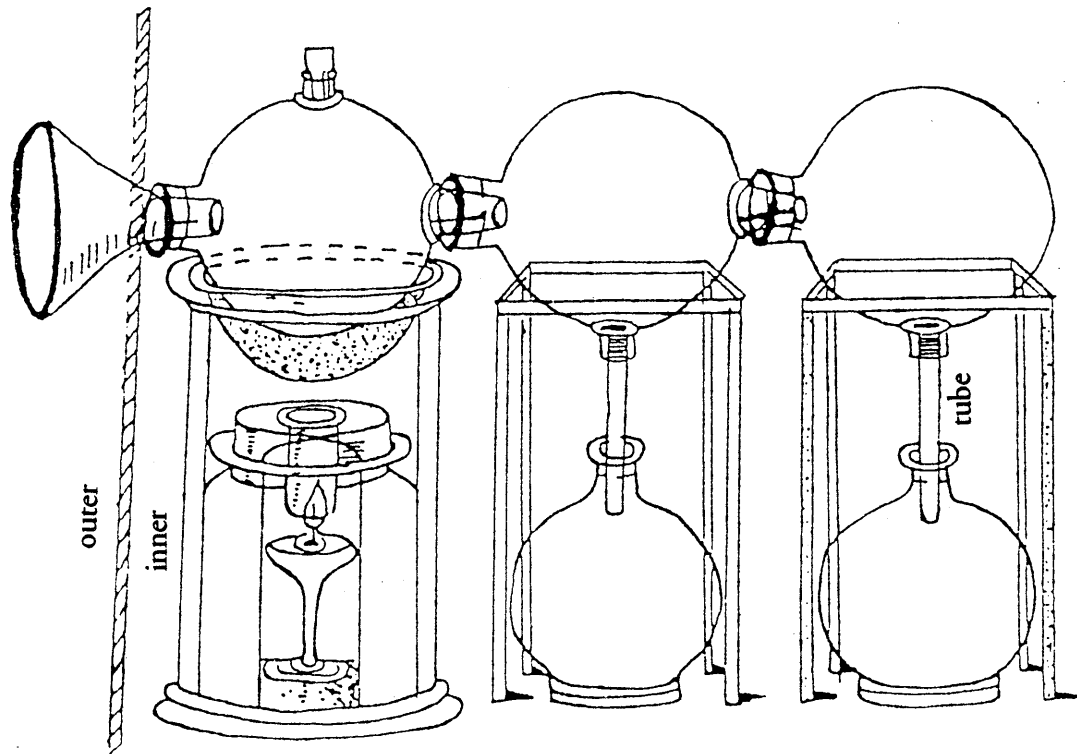

Figure # 2  
C.84.1290

### BACSTROM'S APPARATUS



Legend to the Direct extractor of Solar or Lunar Fire

- E: Glass funnel
- G: Gauze-like cloth to prevent insects and coarse dust
- C: Cover to prevent it from warming up too quickly
- T: Condenser
- R: Water-ice reservoir
- B: Receiving flask
- AS: Vacuum blower (wall fan installed in a box)
- V: Vermiculite

In 1995, the author of the present work wrote: "My name is Jean Dubuis. I am, this present day that I write, aged 76 years old, and I have a practice of esotericism of more than half a century. My esoteric researches started when I was twelve, after a tremendous inner experience; the invisible world had become for me as true as the world of matter where we live. From that time on, I never ceased trying to understand the nature of this experience, to find means to renew it if possible.

"This experience had shown me that there was another truth than the one of our visible world. I wished to be able to understand the nature and workings of this ordinarily invisible Universe. My researches started with books, where I didn't find much, so my early progress was rather slow. Much later, I found the only book that really helped me, the Sepher Yetzirah. After the ill success of books, I became a member of groups of Rosicrucian or Martinist spirit. I did not find really useful elements there. Their habit of illegitimate secrecy led me far from these groups.

"It is, in fact, a persevering personal effort that lead me to renew my experience, and that resulted in my few contacts with the Eternity. From there on, I wrote three courses, one on Alchemy, one on Qabala, and one called The Fundamentals of Esoteric Knowledge."

**Triad Publishing**  
P.O. Box 116  
Winfield, IL 60190

Email: [triad\\_publishing@yahoo.com](mailto:triad_publishing@yahoo.com)  
Web: [www.mcs.com/~alchemy](http://www.mcs.com/~alchemy)